



Suministros
FONTANA. S.L.

INDICE

PAGINAS	ARTICULOS
1 a 2	CHIMENEA
3	CALDERINES, HORNOS
4 a 5	TERMOS ELECTRICOS, ACUMULADORES COBALLES/AQUAFER
6 a 9	REJILLAS VENTILACION
10	TUBO ALUMINIO FLEXIBLE
11	DEFLECTORES INOX, ALUMINIO
12	TUBO ALUMINIO RIGIDO
13 a 14	TUBO ESTUFAS PELLETS Y LEÑA
15 a 17	TUBO CONDUCTO VENTILACION
18	TUBO CONDENSACION
19 a 21	CALENTADORES
22 a 23	CALDERA GAS Y CONDUCTOS
24	TERMOS ELECTRICOS MECALIA
25	TERMOS ELECTRICOS WESEN
26 a 29	ACCESORIOS DE GAS
30	TORNILLOS WC, VARIOS
31	ENTRADAS, SALIDAS LAVADORA, ATOMIZADORES
32 a 36	VALVULAS, GRIFOS ESFERA Y GRIFOS LAVADORA
37	VALVULAS Y PIEZAS INOX
38 a 44	MACHONERIA, PIEZAS LATON Y FLOT. DEPOSITO
45 a 46	RETENCIONES Y SEGURIDAD
47 a 51	MOTORES POZO, HIDROSFERAS, CURVAS Y REDUCT.
52 a 54	BATERIA, CAJAS Y LLAVES DE CONTADORES
55 a 56	FILTROS DE AGUA
57	ABRAZADERA REPARACION Y OTROS
58	ENLACES GEBO Y SERIE 98
59	ACCESORIOS GEBO
60 a 62	ACCESORIOS LATON PARA POLIETILENO
63 a 66	ACCESORIOS POLIETILENO
67	VALVULAS PVC PEGAR, ROSCAR Y CON RAC. POLIET.
68	SOLID MARKER Y CAJONES APILABLES
69	ACCESORIOS FUNDICIÓN
70 a 74	TUBO Y ACCESORIOS P.B.
75	ACCESORIOS RETICULADO
77	ACCESORIOS MULTICAPA
77 a 81	ACCESORIOS MULTICAPA LLAVE
82 a 84	ACCESORIOS MULTICAPA MAQUINA
86 a 87	MULTICAPA IXP
88 a 92	TUBERIA Y ACCESORIOS ACERO INOX
93	TUBERIA COBRE
94	PIEZAS LATON SOLDAR/ROSCAR
95 a 98	ACCESORIOS COBRE SOLDAR
99	ACCESORIOS COBRE SAMBRA
100 a 101	ACCESORIOS TECTITE
102 a 103	COQUILLAS Y TUBO CORRUGADO
105	TWIN SOLAR
106	VALVULAS Y DETENTORES RADIADOR
107	TAPONES Y REDUCCIONES RADIADOR
108	RADIADOR ALEACION ALUMINIO
109	RADIADOR TOALLERO
111	RADIADORES ELÉCTRICOS
112	VOLANTES Y VALVULAS ESFERA EMPO
113	ACCESORIOS CALEFACCION
115 a 121	VARIOS CALEFACCION
122 a 124	SILICONA, ESPUMAS, COLA Y ESTAÑO
125	TAPONES, TEFLÓN Y CAÑAMO
126 a 130	JUNTAS VARIAS



PAGINAS





ARTICULOS

131	LLAVES DE CORTE
132	CONEXIONES
133 a 138	ACCESORIOS CISTERNA
139 a 148	VALVULAS Y SIFONES
149 a 151	BOTES SIFONICOS, SUMIDEROS, CANALETAS
152 a 156	ARQUETAS PVC Y ACCESORIOS, MANGUITOS INOD.
157 a 158	HIDROTUBO
159 a 160	PERFILES, CRUCETAS, SACOS ARENA, ETC.
161 a 163	TAPAS FUNDICION Y CANALETAS
164	CENICEROS
165	DEPÓSITOS DE AGUA
166 a 176	ACCESORIOS PVC EVACUACION
177 a 185	ACCESORIOS RIEGO
186 a 188	ABRAZADERAS VARIAS
189	ABRAZADERAS ISOFONICAS
190	TACOS FISCHER
191	BRIDAS NYLON Y GRAPAS
192	ABRAZADERAS FLEJE, ANCLAJES TORNILLO Y HOJAS DE SIERRA
193	SOPLETES, BOTELLAS Y PISTOLAS
194 a 200	BROCAS
201 a 202	DISCOS
203 a 211	HERRAMIENTAS, VARIOS
212	ESCALERAS
213	PRODUCTOS PARA LEÑA Y PELLETS
230 a 235	FLEXOS, BARRAS Y MANGOS DUCHA
236 a 238	COLUMNAS Y CABINAS HIDROMASAJE
241	ALFOMBRAS, CORTINAS
243 a 244	ASIENTOS DUCHA, BAÑO Y ASAS BAÑO
245 a 246	ASIENTOS WC Y REJILLA PLATO DUCHA
247 a 256	ACCESORIOS CUARTO DE BAÑO
257 a 258	ASA MINUSVALIDOS, DISPENSADORES PAPEL, ETC.
259	ACCESORIOS BAÑO INOX
260 a 269	ARMARIOS Y ESTANTERIAS BAÑO
270 a 273	TABURETES Y DOSIFICADORES BAÑO
277	MONTURAS
278	DUCHA SOLAR Y TRITURADORES WC
279 a 280	TEMPORIZADOS
281	GRIFOS DECORATIVOS JARDIN
282	MICROFILTRACION
283 303	GRIFERIAS BAÑO Y COCINA
309 a 312	FREGADEROS
313 a 314	PLATOS DUCHA
315 a 316	PACK EASY Y LUXOR

TUBERIA AISLADA DOBLE PARED INOX / INOX

TUBOS		Ø 80	Ø 125	Ø 150	Ø 175	Ø 200	Ø 250	Ø 300
	1000 mm	46,59 €	57,69 €	67,28 €	76,29 €	86,13 €	106,56 €	128,07 €
	500 mm	30,20 €	36,15 €	44,45 €	47,16 €	53,55 €	65,61 €	81,60 €
	250 mm	21,15 €	25,30 €	31,14 €	33,02 €	37,49 €	45,92 €	57,12 €
	Extensible Corto 325/535	67,18 €	72,56 €	84,66 €	95,01 €	107,50 €	130,88 €	149,49 €
	Extensible Largo 530/940	100,54 €	110,97 €	130,65 €	147,30 €	159,19 €	196,30 €	231,36 €
	Comprobación 1000 mm		111,63 €	127,41 €	142,97 €	159,73 €	196,01 €	233,90 €
	Comprobación 500 mm		69,08 €	80,46 €	87,46 €	96,69 €	117,87 €	141,30 €
	Silencioso	109,27 €	124,49 €	145,62 €	163,58 €	185,14 €	230,14 €	277,20 €
CODOS		Ø 80	Ø 125	Ø 150	Ø 175	Ø 200	Ø 250	Ø 300
	30°	36,23 €	42,17 €	51,78 €	57,28 €	67,10 €	90,90 €	115,57 €
	45°	40,24 €	45,47 €	55,45 €	61,38 €	71,88 €	97,40 €	123,83 €
	60°		58,65 €	68,42 €	79,87 €	94,01 €	134,48 €	185,40 €
TE con tapón		Ø 80	Ø 125	Ø 150	Ø 175	Ø 200	Ø 250	Ø 300
	90°	67,94 €	79,49 €	96,44 €	115,12 €	131,63 €	168,97 €	212,05 €
	45°	85,32 €	101,28 €	124,38 €	158,72 €	174,70 €	233,68 €	283,81 €
SOMBRERETES		Ø 80	Ø 125	Ø 150	Ø 175	Ø 200	Ø 250	Ø 300
	Normal	23,96 €	27,13 €	30,67 €	34,18 €	43,66 €	61,06 €	76,74 €
	Anti-refluxo	38,16 €	40,85 €	43,74 €	47,97 €	54,75 €	71,14 €	80,42 €
TERMINAL SALIDA LIBRE		Ø 80	Ø 125	Ø 150	Ø 175	Ø 200	Ø 250	Ø 300
		28,92 €	30,04 €	30,83 €	31,90 €	34,69 €	39,19 €	47,12 €
BRIDAS		Ø 80	Ø 125	Ø 150	Ø 175	Ø 200	Ø 250	Ø 300
	Union	6,48 €	6,98 €	7,31 €	7,82 €	8,36 €	9,46 €	11,31 €
	Mural	10,08 €	10,58 €	11,41 €	11,97 €	12,52 €	13,62 €	22,31 €
	Mural Regulable	22,08 €	22,49 €	22,86 €	24,64 €	26,16 €	29,00 €	31,70 €
	Vientos	9,53 €	10,05 €	10,35 €	11,41 €	12,52 €	14,34 €	15,66 €
ADAPTADOR CALDERA		Ø 80	Ø 125	Ø 150	Ø 175	Ø 200	Ø 250	Ø 300
		26,26 €	27,00 €	31,40 €	35,68 €	41,43 €	51,64 €	60,38 €
REDUCCIONES		Ø 80	Ø 125	Ø 150	Ø 175	Ø 200	Ø 250	Ø 300
	Para asignar el precio se tendrá en cuenta el diámetro mayor de la pieza.	59,01 €	64,52 €	66,37 €	72,78 €	74,67 €	78,34 €	106,62 €

TUBOS		Ø 80	Ø 100	Ø 110	Ø 120	Ø 125	Ø 130	Ø 140	Ø 150	Ø 175	Ø 200	Ø 250	Ø 300	Ø 350
		CON JUNTA												
	1000 mm	15,23 €	14,44 €	15,86 €	17,79 €	19,19 €	20,03 €	20,73 €	22,91 €	26,53 €	30,94 €	36,49 €	48,43 €	67,71 €
	500 mm	9,23 €	8,43 €	9,17 €	10,22 €	10,75 €	11,26 €	11,91 €	12,64 €	14,77 €	17,15 €	21,17 €	27,46 €	37,82 €
	Extensible Corto	32,92 €	30,50 €	31,55 €	33,19 €	34,20 €	34,58 €	36,01 €	37,05 €	40,90 €	45,54 €	54,02 €	65,22 €	75,26 €
	Extensible Largo	39,00 €	40,63 €	43,43 €	47,00 €	48,72 €	49,58 €	52,13 €	53,81 €	60,20 €	67,77 €	81,43 €	99,74 €	115,46 €
CODOS		Ø 80	Ø 100	Ø 110	Ø 120	Ø 125	Ø 130	Ø 140	Ø 150	Ø 175	Ø 200	Ø 250	Ø 300	Ø 350
	30°			10,32 €	11,32 €	11,57 €	12,16 €	12,91 €	14,58 €	17,20 €	20,90 €	26,90 €	41,04 €	58,97 €
	45°	9,64 €	6,96 €	10,98 €	11,97 €	11,97 €	12,90 €	13,61 €	15,19 €	18,17 €	22,03 €	31,71 €	43,46 €	62,62 €
	60°			13,53 €	13,98 €	14,96 €	15,88 €	16,97 €	18,40 €	21,88 €	26,53 €	36,65 €	51,45 €	67,87 €
	90°	10,95 €	9,31 €	14,20 €	16,08 €	17,33 €	18,37 €	19,67 €	21,41 €	25,37 €	30,83 €	42,80 €	59,51 €	81,00 €
TE con tapón		Ø 80	Ø 100	Ø 110	Ø 120	Ø 125	Ø 130	Ø 140	Ø 150	Ø 175	Ø 200	Ø 250	Ø 300	Ø 350
	90°	20,61 €	22,39 €	24,12 €	25,77 €	26,70 €	28,14 €	30,40 €	34,54 €	43,11 €	48,64 €	69,99 €	92,76 €	122,79 €
	45°	30,34 €	31,38 €	34,01 €	37,73 €	39,83 €	43,20 €	47,54 €	49,92 €	63,18 €	73,84 €	106,16 €	140,54 €	162,13 €
SOMBRERETES		Ø 80	Ø 100	Ø 110	Ø 120	Ø 125	Ø 130	Ø 140	Ø 150	Ø 175	Ø 200	Ø 250	Ø 300	Ø 350
	Normal	23,73 €	21,75 €	22,52 €	23,38 €	24,22 €	24,30 €	24,64 €	24,99 €	27,45 €	31,02 €	44,17 €	61,77 €	77,64 €
	Anti-reflujo	36,43 €	35,33 €	37,92 €	38,61 €	38,61 €	38,95 €	39,90 €	40,58 €	41,32 €	44,25 €	55,39 €	71,96 €	81,35 €
	Flauta	37,35 €	39,33 €	40,39 €	41,73 €	42,35 €	43,00 €	44,12 €	45,27 €	47,91 €	51,77 €	57,51 €	68,18 €	73,69 €
BRIDAS		Ø 80	Ø 100	Ø 110	Ø 120	Ø 125	Ø 130	Ø 140	Ø 150	Ø 175	Ø 200	Ø 250	Ø 300	Ø 350
	Mural M-8	4,86 €	4,94 €	4,99 €	5,14 €	5,20 €	5,20 €	5,69 €	5,73 €	5,84 €	6,38 €	7,41 €	8,06 €	9,04 €
	Mural	9,09 €	9,35 €	9,63 €	9,90 €	9,90 €	9,90 €	9,90 €	9,90 €	10,40 €	11,21 €	12,30 €	13,38 €	21,91 €
	Mural Regulable	21,55 €	21,68 €	0,00 €	21,68 €	21,68 €	21,68 €	21,98 €	22,00 €	22,09 €	22,45 €	25,70 €	28,48 €	31,13 €
	Vientos	7,77 €	8,02 €	8,26 €	8,51 €	8,51 €	8,51 €	8,51 €	8,51 €	8,97 €	9,24 €	10,19 €	11,18 €	12,80 €
MANGUITOS		Ø 80	Ø 100	Ø 110	Ø 120	Ø 125	Ø 130	Ø 140	Ø 150	Ø 175	Ø 200	Ø 250	Ø 300	Ø 350
	200 mm	5,50 €	6,40 €	6,74 €	7,10 €	7,79 €	8,03 €	8,26 €	8,75 €	10,54 €	11,60 €	14,42 €	17,43 €	21,46 €
	110 mm	3,26 €	3,79 €	3,95 €	4,20 €	4,62 €	4,74 €	4,90 €	5,15 €	6,26 €	6,78 €	8,35 €	10,51 €	12,61 €
REDUCCIONES		Ø 80	Ø 100	Ø 110	Ø 120	Ø 125	Ø 130	Ø 140	Ø 150	Ø 175	Ø 200	Ø 250	Ø 300	Ø 350
	Para asignar el precio se tendrá en cuenta el diámetro mayor de la pieza.	20,39 €	20,93 €	21,67 €	21,96 €	22,22 €	23,01 €	23,72 €	24,27 €	26,86 €	28,64 €	32,20 €	37,14 €	41,07 €
VIERTEAGUAS		Ø 80	Ø 100	Ø 110	Ø 120	Ø 125	Ø 130	Ø 140	Ø 150	Ø 175	Ø 200	Ø 250	Ø 300	Ø 350
		15,98 €	16,93 €	17,52 €	18,16 €	18,30 €	18,48 €	18,82 €	19,13 €	20,50 €	21,65 €	24,31 €	27,14 €	30,62 €

TUBOS	Ø 80	Ø 100	Ø 110	Ø 120	Ø 125	Ø 130	Ø 140	Ø 150	Ø 175	Ø 200	Ø 250	Ø 300	Ø 350	
		CON JUNTA												
	1000 mm	20,57 €	20,82 €	22,90 €	25,18 €	26,20 €	27,38 €	29,46 €	31,85 €	37,30 €	43,02 €	53,92 €	67,19 €	77,39 €
	500 mm	13,00 €	11,77 €	12,95 €	14,20 €	14,82 €	15,46 €	16,62 €	17,92 €	21,02 €	24,21 €	30,31 €	37,64 €	43,44 €
	Extensible Corto	41,84 €	41,87 €	43,79 €	46,48 €	47,69 €	48,18 €	49,86 €	51,06 €	55,72 €	61,61 €	72,41 €	86,08 €	98,53 €
Extensible Largo	51,07 €	53,53 €	56,69 €	60,80 €	62,73 €	63,70 €	66,63 €	68,56 €	75,89 €	84,92 €	122,47 €	140,78 €	176,09 €	
CODOS	Ø 80	Ø 100	Ø 110	Ø 120	Ø 125	Ø 130	Ø 140	Ø 150	Ø 175	Ø 200	Ø 250	Ø 300	Ø 350	
	45°	11,98 €	9,45 €	14,84 €	14,99 €	15,18 €	15,94 €	16,54 €	18,77 €	22,57 €	27,59 €	39,36 €	53,15 €	77,87 €
	90°	13,67 €	12,66 €	19,29 €	20,04 €	21,75 €	23,12 €	24,51 €	26,96 €	31,75 €	38,68 €	53,74 €	76,75 €	105,13 €
TE con tapón	Ø 80	Ø 100	Ø 110	Ø 120	Ø 125	Ø 130	Ø 140	Ø 150	Ø 175	Ø 200	Ø 250	Ø 300	Ø 350	
	90°	25,82 €	28,66 €	30,95 €	33,07 €	34,35 €	35,83 €	38,19 €	42,28 €	52,14 €	59,14 €	86,79 €	116,78 €	153,60 €
	45°	36,96 €	38,95 €	42,24 €	46,78 €	48,68 €	54,27 €	59,92 €	63,00 €	80,67 €	94,41 €	129,86 €	180,94 €	210,35 €
SOMBRETERES	Ø 80	Ø 100	Ø 110	Ø 120	Ø 125	Ø 130	Ø 140	Ø 150	Ø 175	Ø 200	Ø 250	Ø 300	Ø 350	
	Normal	28,95 €	27,79 €	28,94 €	30,12 €	31,41 €	31,50 €	31,58 €	31,80 €	34,58 €	38,91 €	55,89 €	79,50 €	98,29 €
	Anti-reflujo	44,53 €	44,53 €	48,31 €	49,51 €	49,51 €	49,86 €	51,24 €	52,23 €	52,72 €	56,07 €	72,63 €	95,71 €	109,22 €
REDUCCIONES	Ø 80	Ø 100	Ø 110	Ø 120	Ø 125	Ø 130	Ø 140	Ø 150	Ø 175	Ø 200	Ø 250	Ø 300	Ø 350	
	Para asignar el precio se tendrá en cuenta el diámetro mayor de la pieza.	22,58 €	23,63 €	24,56 €	24,85 €	25,07 €	25,25 €	26,36 €	26,96 €	29,38 €	30,15 €	34,40 €	38,92 €	42,76 €

LIMA CHIMENEA	Ø	80	100	110	120	125	130	140	150	160	170	175	180	200	250	300	350	
	304/0,5	€	88,84	89,24	91,63	96,36	98,68	101,30	106,92	112,54	118,16	123,74	126,15	128,78	139,76	167,03	194,48	221,94
	PLOMO-304	€	173,35	173,69	174,02	174,23	174,44	179,39	189,29	199,17	209,03	218,93	223,75	228,43	248,35	297,56	346,87	396,20
			Ø	400	450	500												
	304/0,5	€	249,42	278,87	306,50													
	PLOMO-304	€	445,50	494,81	544,14													

Interior 316 // Exterior 304

TUBERIA AISLADA DOBLE PARED INOX / INOX

TUBOS		Ø 80	Ø 125	Ø 150	Ø 175	Ø 200	Ø 250	Ø 300
	1000 mm	58,64 €	75,45 €	87,26 €	98,62 €	111,30 €	137,97 €	165,75 €
	500 mm	30,14 €	44,25 €	54,56 €	57,63 €	65,82 €	80,19 €	100,15 €
	250 mm	21,08 €	30,97 €	38,21 €	40,35 €	46,07 €	56,14 €	70,11 €
	Extensible Corto 325/535	75,80 €	85,17 €	97,27 €	109,22 €	122,64 €	147,58 €	175,47 €
	Extensible Largo 530/940	102,05 €	114,24 €	132,51 €	152,41 €	170,96 €	204,64 €	238,28 €
CODOS		Ø 80	Ø 125	Ø 150	Ø 175	Ø 200	Ø 250	Ø 300
	30°	38,18 €	42,32 €	57,89 €	63,17 €	73,79 €	100,64 €	127,97 €
	45°	50,84 €	51,16 €	61,68 €	70,69 €	84,15 €	111,27 €	141,12 €
	60°		64,02 €	79,73 €	89,55 €	105,37 €	153,94 €	210,13 €
TE con tapón		Ø 80	Ø 125	Ø 150	Ø 175	Ø 200	Ø 250	Ø 300
	90°	72,00 €	86,88 €	114,28 €	132,78 €	156,30 €	206,74 €	266,42 €
	45°	97,84 €	123,39 €	146,23 €	177,85 €	198,31 €	258,40 €	317,38 €
SOMBRERETES		Ø 80	Ø 125	Ø 150	Ø 175	Ø 200	Ø 250	Ø 300
	Normal	28,42 €	31,28 €	35,21 €	39,32 €	50,57 €	71,94 €	88,94 €
	Anti-refluxo	44,80 €	47,70 €	50,74 €	56,58 €	65,72 €	86,62 €	98,82 €
ADAPTADOR CALDERA		Ø 80	Ø 125	Ø 150	Ø 175	Ø 200	Ø 250	Ø 300
		28,18 €	29,40 €	34,06 €	38,54 €	44,68 €	55,75 €	65,12 €
REDUCCIONES		Ø 80	Ø 125	Ø 150	Ø 175	Ø 200	Ø 250	Ø 300
	Para asignar el precio se tendrá en cuenta el diámetro mayor de la pieza.	63,76 €	71,51 €	74,02 €	83,18 €	86,99 €	92,90 €	128,08 €

Hornos para cocinas

Acero inoxidable AISI 430

MODELO	REFERENCIA	PRECIO
Nº 7	113010	126,40 €
Nº 8	113011	126,40 €
Nº 9	113012	131,95 €
Medidas especiales		CONSULTAR
Bandeja Hornos Nº 7 / 8		22,00 €
Bandeja Horno Nº 9		26,00 €

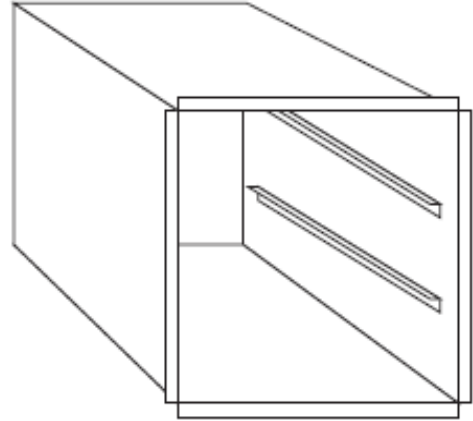

OFERTA

MODELO	CANT.	PRECIO
Nº 7 y 8	6	CONSULTAR
Nº 9		CONSULTAR

Soportes para radiador

MODELO PARA ATORNILLAR	REFERENCIA	PRECIO
2 - CF	109010	1,03 €
3 - CF	109011	1,27 €
4 - CF	109012	1,33 €
3 - CA	109013	1,03 €
4 - CA	109014	1,03 €

MODELO PARA ATORNILLAR	CODIGO	UN	PRECIO
REGULABLE		50	2,33 €
		100	2,25 €

MODELO PARA ATORNILLAR	REFERENCIA	PRECIO
Poliamida	392018583	0,57 €

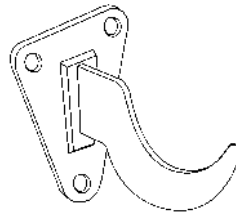

NOVEDAD
New



Modelo patentado
Patented model

El precio es por juego compuesto por:
2 soportes + tornillos + tacos.

PINGÜINO

Juego soporte regulable para radiador de aluminio. Incluye 2 soportes, 2 tacos Ø10 mm largo 6 cm, 2 tornillos y 2 arandelas.

Código	Regulación en vertical		PVP € PAR
100550	25 mm	30	4,97



Tapas de Pozo

Acero inoxidable AISI 304

ROSCA	REFERENCIA	PRECIO
1"	111010	61,97 €
1 1/4"	111011	65,55 €
1 1/2"	111012	91,76 €
2"	111013	102,49 €

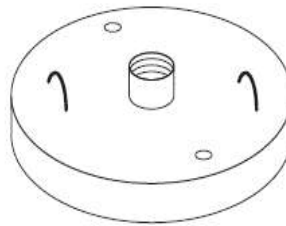

Otros

ARTICULO	REFERENCIA	PRECIO
Vaina Inox rosca 1 1/4" para resistencias de 1200 w.	800092	119,70 €
Vaina Inox rosca 1 1/4" para resistencias de 2400 w.	800094	158,34 €
Flotador con boya inox 3/8"	114014	28,19 €
Boya Inox	114015	23,14 €
Vaina Inox L: 100mm Ø: 8mm	114020	20,87 €
Vaina Inox L: 200mm Ø: 8mm	114021	20,87 €
Vaina Inox L: 250mm Ø: 8mm	114022	23,45 €
Anodo Mangnesio 3/4" L 400mm	5005001	33,03 €
Anodo Elec. 1/2" 680 hasta 1000 litros	5005002	230,32 €
Anodo Elec. 1/2" 780 más de 1000 litros	5005003	250,92 €
Kit Eléctrico (Todos los modelos de 80 a 100 litros)	9006057	226,49 €
Kit Eléctrico (Todos los modelos de 125 a 300 litros)	9006058	226,49 €
Kit Eléctrico (Sólo Modelos A 20)	9006064	226,49 €
Resistencia Varilla 600 w.	800042	26,22 €
Resistencia Varilla 1200 w.	800043	39,24 €

Varios

Vasos expansión abiertos

Acero inoxidable AISI 304

CAPACIDAD (L)	REFERENCIA	PRECIO	DIMENSIONES GENERALES (mm)		
			A	B	C
18	110010	105,41 €	330	160	340
26	110011	130,86 €	330	200	400
50	110012	233,61 €	450	250	450

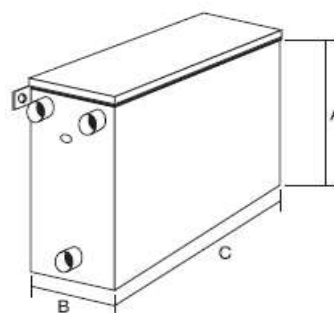

SILENT 100

Flotador de latón cromado y asiento en inox con varilla roscada (boya no incluida en precio).



REFERENCIA	MEDIDA	PRECIO
100017	3/8"	16,63 €

402

Boya plana plástico con racor insertado en latón 1/4"H. Para agua caliente máx.: 120°C. Para flotadores SILENT 100/107.



REFERENCIA	Ø	PRECIO
402009	90 mm	3,95 €

Calderín para cocinas

Acero inoxidable AISI 304

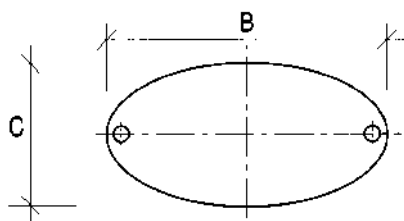

CAPACIDAD (L)	REFERENCIA	PRECIO	DIMENSIONES GENERALES (mm)			
			A	B	C	D
35	108010	267,73 €	460	405	220	355
55	108011	336,81 €	560	485	265	430

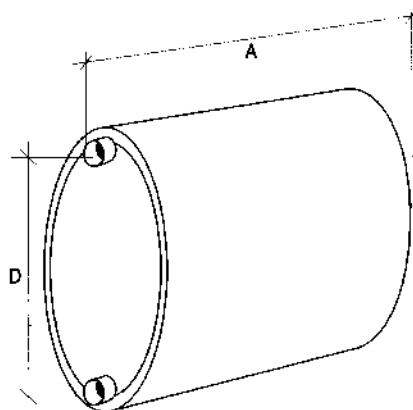

Cubre encimeras para cocinas

Acero inoxidable AISI 430

CON BORDES SIMPLES			
DIMENSIONES (mm)	MODELO	REFERENCIA	PRECIO
910 x 510	Nº 7	112010	99,68 €
1030 x 560	Nº 8	112011	103,20 €
1120 x 560	Nº 9	112012	107,60 €
1210 x 560	Nº 10	112013	114,50 €
930 x 600			100,25 €
1030 x 600			112,43 €
1130 x 600			115,50 €
1230 x 600			119,30 €

CON BORDES PLEGADOS			
DIMENSIONES (mm)	MODELO	REFERENCIA	PRECIO
910 x 510	Nº 7	112020	CONSULTAR
1030 x 560	Nº 8	112021	CONSULTAR
1120 x 560	Nº 9	112022	CONSULTAR
1210 x 560	Nº 10	112023	CONSULTAR

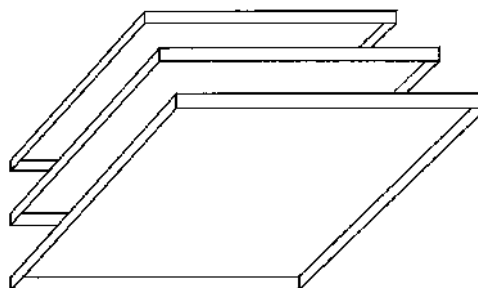

Termo Eléctrico

E20DP
TERMO ELECTRICO
DOBLE POSICIÓN



REFERENCIA	CAPACIDAD	CLASE	TENSION (V)	PRESION MAXIMA	Tª MAXIMA	MEDIDAS (mm)		PRECIO
	litros					ALTURA	DIÁMETRO	
3021100050	50	B	230	8 bar	90 °C	800	420	753,00 €
3021100080	80	B	230	8 bar	90 °C	1030	420	854,00 €
3021100100	100	B	230	8 bar	90 °C	1230	420	935,00 €
3021100150	150	C	230	8 bar	90 °C	1300	530	1.140,00 €
3021100200	200	C	230	8 bar	90 °C	1315	600	1.379,00 €

COBALLES **A20**
INTERACUMULADOR DOBLE ENVOLVENTE
Double wall DHW tank



Code	Description	Energie class	Heating elem.	Placement	Side	Heat exchanger tank	Tank max pressure	Hight	Diam.	Freigh weight	Price
Ref.	Descripción	Clasificación energética	Resist.	Instalación	Orientación	Superficie intercambio acum.	Presión Máx. depósito	Altura	Diam.	Peso logístico	PVP
						[m²]	[bar]	[mm]	[mm]	[Kg]	[€]
A20 80^L	2711010080 2721010080	A B	●	Suelo/pared	Vert./horiz.	0,45	8	1075 970	490 430	38 25	1.152,00 1.002,00
A20 100^L	2711010100 2721010100	A B	●	Suelo/pared	Vert./horiz.	0,65	8	1275 1170	490 430	45 31	1.311,00 1.140,00
A20 150^L	2711010150 2721010150	A B	●	Suelo/pared	Vert./horiz.	0,82	8	1300 1245	560 530	60 46	1.474,00 1.282,00
A20 200^L	2711010200 2721010200	A B	●	Suelo/pared	Vert./horiz.	1,00	8	1380 1300	660 600	75 58	1.925,00 1.674,00
A20 300^L	2710010300 2720010300	A B	●	Suelo	Vert./horiz.*	1,41	8	1900 1830	660 600	105 84	2.417,00 2.045,00



TERMO ELECTRICO

- Versión Mural, disposición Vertical.
- En Acero inoxidable 444 (garantía 5 años) o Acero inoxidable Duplex 2205 (garantía 10 años).
- Termostato digital LCD inteligente.

Modelo	TERMO 80	TERMO 100	TERMO 150
Ref. Inox 2205	94202052100	94202052101	94202052103
Ref. Inox 444	94202052107	94202052108	94202052110
Instalación	Vertical Mural		
Capacidad	72,4 litros	100 litros	150 litros
Resistencia	Resistencia Titanio 1500 W		
Controlador	Termostato Digital Inteligente LCD		
Presión Máxima	(7 bar Inox 444) // (8 bar Inox 2205)		
Acabado exterior	Chapa metálica esmaltada en blanco		
Aislamiento	Poliuretano rígido inyectado PU Espesor 30 mm densidad 42 Kg/m ³		
Diámetro	540 mm	540 mm	540 mm
Altura	618 mm	767 mm	1018 mm
Peso en vacío	22,5 Kg	26,5 Kg	32 Kg

1. Entrada fría [1/2" M]
2. Salida caliente [1/2" M]
3. Sonda/recirculación [1/2" H]
4. Resistencia [1" 1/4 H]

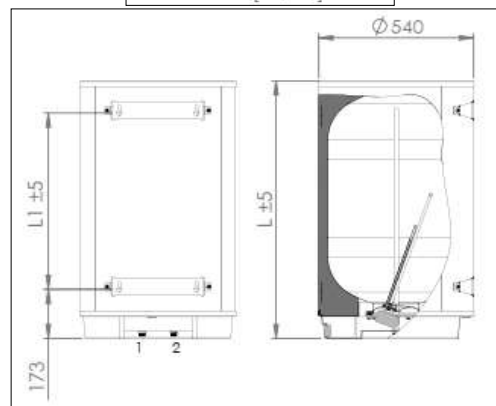

Modelo	TERMO 80	TERMO 100	TERMO 150
INOX 2205	729,56 €	765,95 €	887,94 €
INOX 444	535,40 €	572,72 €	634,60 €

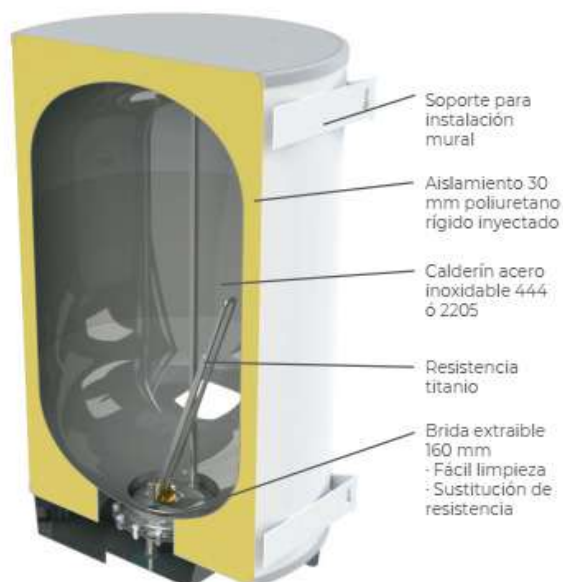
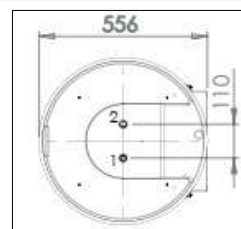

- Interfaz intuitiva y limpia
- Pantalla LCD retroiluminada
- 3 modos de funcionamiento (auto, manual y vacaciones)
- Aprende los hábitos de consumo y ahorra energía
- Bloqueo infantil, ciclo antolegionela



S20N

INTERACUMULADOR SERPENTIN
Single coil Tank

NEW



Description	Code	Energie class	Heat elem.	Placement	Power	Heat exchanger	Height	Diam.	Freigh weight	Price
Descripción	Ref.	Clasificación energética	Resist.	Instalación	Potencia	Superficie intercambio	Altura	Diam.	Peso logístico	PVP
					[Kw a 70°C]	[m²]	[mm]	[mm]	[Kg]	[€]
S20N 80^L	2011010080	A	⊕	Suelo/Pared	11	0,38	1055	490	29	968,00
	2021010080	B					980	430	24	842,00
S20N 100^L	2011010100	A	⊕	Suelo/Pared	11	0,38	1255	490	38	1.054,00
	2021010100	B					1170	430	36	934,00
S20N 150^L	2011010150	A	⊕	Suelo/Pared	16	0,57	1280	560	50	1.304,00
	2021010150	B					1245	530	48	1134,00
S20N 200^L	2011010200	A	⊕	Suelo/Pared	22	0,75	1360	660	64	1.635,00
	2021010200	B					1300	600	59	1.422,00
S20N 250^L	2010010250	A	⊕	Suelo	22	0,75	1610	660	80	1.810,00
	2020010250	B					1600	600	75	1.502,00
S20N 300^L	2010010300	A	⊕	Suelo	27	1,00	1900	660	101	1.995,00
	2020010300	B					1830	600	95	1.751,00

Presión max.: 8 bar



2S20N









INTERACUMULADOR DOBLE SERPENTIN
Double coil Tank

NEW



Description	Code	Energie class	Heat elem.	Placement	Power	Heat exchanger	Height	Diam.	Freigh weight	Price
Descripción	Ref.	Clasificación energética	Resist.	Instalación	Potencia	Superficie intercambio	Altura	Diam.	Peso logístico	PVP
					[Kw a 70°C]	[m²]	[mm]	[mm]	[Kg]	[€]
					sup inf	sup inf				
2S20N 150^L	2111010150	A	⊕	Suelo/pared	11 16	0,38 0,57	1280	560	54	1.446,00
	2121010150	B					1245	530	52	1.160,00
2S20N 200^L	2111010200	A	⊕	Suelo/pared	11 22	0,38 0,75	1360	660	68	1.812,00
	2121010200	B					1300	600	63	1.518,00
2S20N 250^L	2110010250	A	⊕	Suelo	16 22	0,57 0,75	1610	660	85	2.454,00
	2120010250	B					1600	600	75	2.113,00
2S20N 300^L	2110010300	A	⊕	Suelo	16 22	0,57 0,75	1900	660	83	2.525,00
	2120010300	B					1830	600	78	2.169,00

Presión max.: 8 bar

MODELO	DESCRIPCION	UN	PRECIO
	L-601 REJILLA PVC EMPOTRABLE 15x15 BLANCA CON PESTAÑA	100	1,32 €
	L-603 REJILLA PVC EMPOTRABLE 15x15 BLANCA CON PESTAÑA Y CIERRE	100	3,30 €
	REJILLA ABS BLANCA SUPERFICIE 23 x 23 200 cm ² CON RED.	50	4,53 €
	L-605 REJILLA PVC EMPOTRABLE 20x20 BLANCA CON PESTAÑA Y CIERRE	50	4,82 €
	L-607 REJILLA PVC EMPOTRABLE 9x21 BLANCA VERTICAL Y CON PESTAÑA	100	1,78 €
	L-608 MARCO PARA REJILLA L-607	100	0,87 €
	L-609 REJILLA PVC EMPOTRABLE 15x30 BLANCA	100	3,03 €
	L-610 REJILLA PVC EMPOTRABLE REDONDA Ø 15 CON PESTAÑA	100	1,48 €
	L-110 REJILLA PVC EMPOTRABLE 9x21 BLANCA VERTICAL, CON PESTAÑA Y CIERRE	100	2,18 €
	L-113 REJILLA PVC EMPOTRABLE REDONDA Ø 20 CON PESTAÑA	50	1,75 €

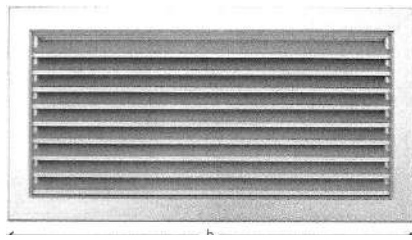

REJILLA ABS
630 x 220 BLANCA
C/RED

AR 5023 B

6 **9,83 €**

REJILLAS ALUMINIO

REJILLA EMPOTRAR				REJILLA C/PESTAÑA		
MEDIDA	COLOR	UN	PRECIO	MEDIDA	COLOR	PRECIO
15 x 15	ANODIZADA	50	1,52 €	18 x 18	ALUMINIO	1,25 €
15 x 15	BLANCA	50	1,66 €			

REJILLA PLANA			
MEDIDA	COLOR	UN	PRECIO
15 x 15	ALUMINIO	50	1,11 €
15 x 15	BLANCA	50	1,28 €
17 x 17	ALUMINIO	50	1,33 €
17 x 17	BLANCA	50	1,74 €
15 x 30	ALUMINIO	25	1,49 €
15 x 30	BLANCA	25	2,44 €
17 x 17	MADERA	25	1,97 €
20 x 20	MADERA	25	2,98 €

Rejilla de empotrar universal		REJILLA COBRE 193 x 165		UN	PRECIO
	con red			10	12,20 €
Rejilla de superficie		REJILLA INOX 10 x 10		10	9,26 €
	con red	REJILLA INOX 15 x 15		10	11,13 €
		REJILLA INOX 15 x 16 C/CIERRE		10	31,63 €
		REJILLA INOX 17 x 17		10	11,96 €
		REJILLA INOX 22 x 22		10	17,82 €
		REJILLA INOX 15 x 30		10	19,32 €

REGISTROS DE BAÑERA 30 x 30				Rejilla pvc TOPLINE Universal	
UN	PRECIO			UN	PRECIO
3	8,76 €			12	5,88 €
				Ø 125 - 160	

REJILLA REDONDA DE ENCASTRAR CON RED ANTI-INSECTOS INYECTADA							
Diámetro mm.	Ø 60	Ø 80	Ø 100	Ø 120	Ø 160	Ø 200	
Código	99536	99537	99538	99539	99540	99541	
PRECIO	1,27 €	1,63 €	1,50 €	1,70 €	3,30 €	5,65 €	
UN	25	25	25	25	25	25	

JUEGO DE REJILLAS TELESCOPICAS PARA PUERTAS		Rejilla aluminio anodizado c/cierre			
	Medida mm.	450 x 90			
	Código	99530			
	PRECIO	6,98 €			
	UN	25			
	MEDIDA	COLOR	UN	PRECIO	
	15 x 15	ALUMINIO	6	24,97 €	



LÍNEA COVENT

	Blanca	Marrón
Diámetro mm.	180x45	180x45
Código producto	99528	99528
Paso de aire cm ²	60	60
Diámetro marco mm	A	Ext. 180x45
	B	Aguj. 170x35
	C	Prof. 8

CANT.	PRECIO
25	3,22 €

REJILLA ALUMINIO 51 x 50



Agujero de luz
Sustraer mm 40 de base "b" y altura "h"
Paso: 16 mm

PRECIO
125,00 €

REJILLA REDONDA COBRE



CODIGO	MEDIDA	CANT.	PRECIO
	Ø		
UNI30-6101	100	12	14,48 €
UNI30-6121	120	12	16,18 €
UNI30-6427R	Univ. 120/160	6	28,17 €

REJILLA REDONDA ALUMINIO



CODIGO	MEDIDA	CANT.	PRECIO
	Ø		
UNI20-6100	100	25	6,57 €
UNI20-6120	120	25	8,85 €
UNI20-6427A	Univ. 120/160	12	12,05 €

REJILLAS DE VENTILACION

REJILLA PLEGABLE "DENTRO>FUERA"

"DENTRO>FUERA" es la rejilla mas innovadora, unica en el mercado, marcada "LA VENTILAZIONE". Extremadamente practica, segura, robusta, permite la puesta en obra desde el interior de la vivienda sin necesidad de utilizaiz escaleras, andamios, etc... con el consiguiente ahorro economico.

La facilidad de su puesta en obra permite sustituir viejas rejillas, asi como traelars al interior para su limpieza.

Las rejillas llevan incluidas un cordón que asegura su puesta al exterior con la garantia de no perderlas en el caso de que se escaparan de la mano.











La secuencia fotografica demuestra la facilidad de instalacion de la rejilla "DENTRO>FUERA"

REFERENCIA	COLOR	Ø ext.	Ø tuberia	UN	PRECIO
DF 140B	blanco	170	100 a 140	36	8,70 €
DF 160B	blanco	186	125 a 160	36	10,75 €

**EXTRACTOR HELICOIDAL
para cuartos de baño**



Ø	Voltios	Caudal (m ³)	PRECIO
100	230	98	58,71 €
120	230	180	72,10 €

REJILLAS DE CHIMENEA CON PREMARCO



ref. RE 15 B - 15x15 cm.

UN	€
10	11,96



ref. RE 15 G - 15x15 cm.

UN	€
10	11,96



ref. RE 15 L - 15x15 cm.

UN	€
10	29,97



ref. RE 18 RB 100

UN	€
6	35,80



ref. RE 18 RG 100

UN	€
6	35,80



ref. RE 18 RL 100

UN	€
6	39,80



ref. RE 30 B - 15x30 cm.

UN	€
10	15,65

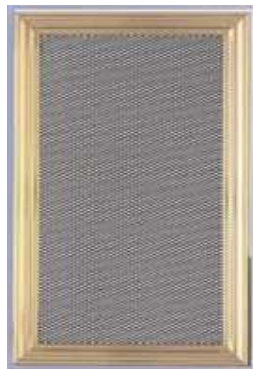

ref. RE 30 L - 15x30 cm.

UN	€
10	43,00

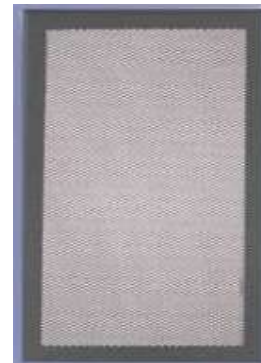

ref. RE 30 G - 15x30 cm.

UN	€
10	15,65



ref. XFC 30 DRG - 15x30 cm.

Regulable - 2 salidas de 100mm Ø

UN	€
6	42,00



CARACTERÍSTICAS

Su espiral estriada asegura una flexibilidad conforme a su utilización y fácil manejo. Se puede flexionar varias veces sin que sufra rotura su pared.

Estanqueidad total contra la pérdida de grasas y humos. Resistencia temperatura 300 °C.

APLICACIONES

Para toda clase de aspiraciones de humos y gases de chimeneas, cocinas, fábricas, etc.

Diámetro int.en mm	Tiras por caja	Metros int.en mm
75	30	150
80	25	125
90	25	125
100	20	100
110	16	80
120	16	80
125	15	70
130	12	60
140	90	45
150	9	45
160	9	45
180	6	30
200	4	20
225	2	10
250	2	10
300	1	5
350	1	5
400	1	5
450	1	5
500	1	5

TUBO ALUMINIO COMPACTO PARA SALIDA DE GASES

Ø int. mm	PRECIO (€) metro lineal		Caja
	Color Standard	Color Blanco	
90	2,70	4,55	25
100	2,78	4,56	20
110	3,05	5,18	16
120	3,36	5,32	16
125	3,82	6,37	16
130	4,07	6,76	12
140	4,30	7,19	9
150	4,56	7,82	9
160	5,25	8,54	9
180	5,65		6
200	6,18	10,28	4
225	7,49		4

**CAJA
COMPLETA**

**Descuento
5%**

TABLA DE EQUIVALENCIAS

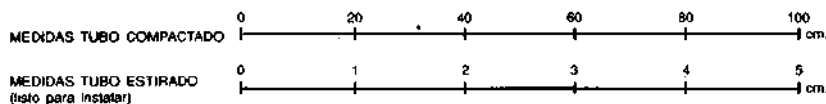

CADA 20 cm. DE TUBO COMPACTADO, EQUIVALE A 1 m. DE TUBO ESTIRADO

Tubos de Distribucion de Aire Caliente

Tubo flexible con aislamiento de hoja de aluminio para distribución de aire caliente.
Micro perforado para atenuación acústica



Referencia	Descripción	Caja	PRECIO/Metro
	TRiflex – Tubo c/aislamiento Ø 80mm; temp. 250 °C	10 metros	4,67 €
100804100	TRiflex – Tubo c/aislamiento Ø 102mm; temp. 250 °C	10 metros	3,70 €
100804125	TRiflex – Tubo c/aislamiento Ø 127mm; temp. 250 °C	10 metros	4,18 €
100804150	TRiflex – Tubo c/aislamiento Ø 152mm; temp. 250 °C	10 metros	4,50 €

SOMBREROS Y DEFLECTORES

SOMBRERO GIRATORIO ROLEX INOX



Ø	UN	PRECIO
80	1	97,46 €
100	1	97,93 €
110	1	98,11 €
120	1	99,05 €
125	1	100,81 €
130	1	102,19 €
150	1	103,97 €
170	1	105,94 €
175	1	106,07 €
200	1	130,65 €
210	1	135,08 €
220	1	136,86 €
250	1	138,74 €
260	1	152,31 €
300	1	169,26 €

SOMBRERO GIRATORIO GALLO INOX



Ø	UN	PRECIO
80	1	84,74 €
100	1	75,10 €
110	1	75,16 €
120	1	75,22 €
125	1	80,05 €
130	1	80,39 €
150	1	86,01 €
170	1	90,30 €
175	1	91,67 €
200	1	102,48 €
210	1	120,74 €
220	1	123,05 €
250	1	125,91 €
260	1	129,59 €
300	1	143,84 €

SOMBRERO INOX GAS

Normal ó Invertido // Sin Abrazadera



Ø	UN	PRECIO
80	12	10,24 €
100	12	10,71 €
110	12	11,62 €
120	12	12,13 €
125	6	13,00 €
130	6	16,56 €
150	6	25,46 €
175	6	28,96 €
200	6	45,60 €

Caja completa descuento **5 %**

SOMBRERO INOX FIJO

Normal ó Invertido // Con Abrazadera



Ø	UN	PRECIO
80	12	17,27 €
100	12	17,74 €
110	12	19,61 €
120	12	20,16 €
125	6	21,74 €
130	6	22,46 €
150	6	32,35 €
175	6	46,10 €
200	6	56,45 €
210	1	67,86 €
220	1	70,08 €
250	1	80,91 €
300	1	111,60 €

DEFLECTOR 3 DISCOS ESMALTADO BLANCO



Ø	UN	PRECIO
100	12	3,68 €
110	12	3,68 €
120	12	6,37 €



INOXIDABLE MATE









MEDIDA	PRECIO
40 x 40	263,20 €
40 x 50	280,69 €
40 x 60	312,39 €

MEDIDA	PRECIO
50 x 50	299,80 €
50 x 80	406,60 €
60 x 80	430,57 €





TUBO Y ACCESORIOS ESTANCOS EN ALUMINIO LACADO BLANCO

TUBOS		Ø 80	Ø 100	Ø 110	Ø 125	Ø 130	Ø 140
	100 cm	15,20 €	15,16 €	15,42 €	17,56 €	22,36 €	29,87 €
	50 cm	7,24 €	9,14 €	9,50 €	11,44 €	11,80 €	15,58 €
CODO 90°		Ø 80	Ø 100	Ø 110	Ø 125	Ø 130	Ø 140
		12,54 €	12,54 €	13,52 €	15,20 €	15,96 €	40,94 €
CODO 45°		Ø 80	Ø 100	Ø 110	Ø 125	Ø 130	Ø 140
		12,54 €	12,54 €	13,52 €	15,20 €	15,96 €	40,94 €
MANGUITO UNION		Ø 80	Ø 100	Ø 110	Ø 125	Ø 130	Ø 140
		6,10 €	6,62 €	6,98 €	7,60 €	7,98 €	8,56 €
SOMBRERO 3 DISCOS		Ø 80	Ø 100	Ø 110	Ø 125	Ø 130	Ø 140
		13,32 €	13,66 €	15,72 €	16,74 €	15,98 €	18,50 €
ABRAZADERA PARED		Ø 80	Ø 100	Ø 110	Ø 125	Ø 130	Ø 140
	Con patas	4,32 €	6,70 €	7,04 €	8,40 €	8,40 €	9,40 €
	M-6	2,82 €	3,00 €	3,13 €	3,10 €	3,10 €	3,19 €
	Fija	2,06 €	2,10 €	2,16 €	2,32 €	2,54 €	3,06 €
ADAPTADOR 200		Ø 80	Ø 100	Ø 110	Ø 125	Ø 130	Ø 140
		6,26 €	6,26 €	6,42 €	7,32 €	7,32 €	7,54 €
ROSETON INTERIOR		Ø 80	Ø 100	Ø 110	Ø 125	Ø 130	Ø 140
		7,78 €	8,18 €	8,60 €	8,98 €	9,26 €	9,97 €



	Referencia	Medidas mm	UN	PVP € / ud
Tubo	8-250MHP4	Ø 80 x 250	1	17,10
Simple	8-500MHP4	Ø 80 x 500	1	23,70
Macho	8-1000MHP4	Ø 80 x 1000	1	34,85
Hembra				



Codo 90°	8-90MHP4	Ø 80	1	23,39
Simple				
M – H				



Codo 45°	8-45MHP4	Ø 80	1	20,19
Simple				
M – H				



T Recoge	8TERHP4	Ø 80	1	51,45
Hollín				
Simple				



Deflector	8DFVPE4	Ø 80	10	26,00
Evacuación				
Vertical				



Deflector	8DFHPE4	Ø 80	10	8,00
Evacuación				
Horizontal				



Deflector	8DFARPE4	Ø 80	1	45,00
Anti-				
Revoque				



Plafón	8PLPE4	Ø 80	1	19,56



Abrazadera	8ABPREL	Ø 80	25	12,45
Pared	10ABPREL	Ø 100	25	13,80



Ampliación	810AMPMP4	Ø 80 x 100	6	26,35
Macho				
Hembra				

**MATERIALES**

INOX 316, espesor 0,5MM, Pintado negro Epoxi.

Juntas de silicona y lana de roca de 30 mm. de espesor y densidad 150 kg/m3.

APLICACIONES

Para instalar en el hogar, en proximidad de personas y animales empleando los módulos protegidos Ø80/100.

Módulos simples Ø80, recomendados en lugares de difícil acceso de personas y animales.

Módulos aislados con lana de roca para instalaciones en el exterior de la vivienda.

Accesorios de transición entre diferentes tipo de módulos y diámetros.

CALIDAD

Curvas estampadas lisas y redondeadas, sin aristas ni obstrucciones internas.

Permiten un mejor paso de humos y una menor pérdida de carga.

Facilitan la limpieza y acumulan menos suciedad, ocupan menos espacio respecto a los codos de gajos.

Estética redondeada en armonía con el entorno de un hogar moderno.

Terminal horizontal en inox Ø80 de rejilla con hilo fino. Evita la acumulación de residuos.

NORMAS Y HOMOLOGACIONES

Pellex316 esta conforme a RITE en vigor y norma UNE 123001

PelleX316

Suministros
FONTANA, S.L.

No 13

DEKO LEÑA

CE 0063 CPD 0657
EN 1022-2 TUBOS EN VITRO CERAMICO

Conducto de pared simple
vitrificado en negro mate

Ø 125 a
Ø 200

CARACTERISTICAS TECNICAS

Espesor: 0,8 mm.
Acabado: Negro mate.

VENTAJAS

RESISTENCIA

Gracias a su vitrificado interior y exterior, la gama DEKO LEÑA garantiza la estabilidad del color y la resistencia a altas temperaturas y a las condensaciones.

ESTETICA

El DEKO LEÑA, con su apariencia completamente lisa, sin resacas ni imperfecciones, permite observar toda la estética de una conexión vista en un estuche diseño.



Ver modelos P37, P38 y P38











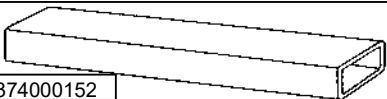
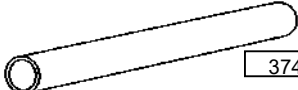
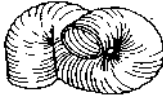

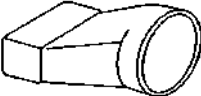

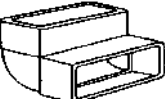
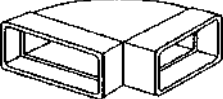

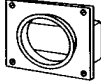

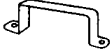

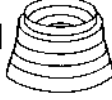
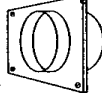
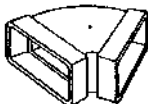



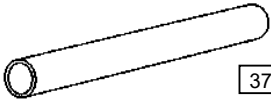
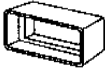

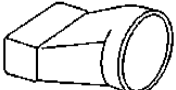
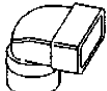

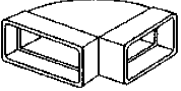
Ø	020 Módulo recto L=950 mm	024 Módulo recto L=450 mm	025 Módulo recto L=285 mm
125	30,06 €	25,36 €	23,45 €
150	33,17 €	27,75 €	25,46 €
180	37,79 €	30,46 €	27,68 €
200	43,72 €	34,44 €	31,23 €

Ø	042 Codo 30°	040 Codo 45°	433 Codo 90°
125	31,35 €	26,40 €	32,55 €
150	33,11 €	27,82 €	34,36 €
180	38,07 €	29,69 €	39,51 €
200	41,17 €	32,66 €	42,72 €

Ø	40A Codo 45° offset L=150 mm	031 Te 90° con entronque Macho	061** Colector hollín con desagüe	120 Módulo con puerta de regulación	1C0 Acoplamiento condensados	022 Módulo extensible largo L=120-450 mm	010** Sombrerete
125	42,64 €	45,53 €	54,72 €	25,27 €	37,94 €	46,03 €	43,21 €
150	46,16 €	48,62 €	65,55 €	28,31 €	40,71 €	50,33 €	47,25 €
180	47,39 €	53,11 €	71,32 €	30,63 €	46,53 €	59,10 €	55,50 €
200	53,43 €	56,34 €	75,49 €	34,52 €	48,81 €	63,39 €	59,52 €

Ø	113 Placa remate circular	075 Anclaje ligero con tuerca	026 Ampliación/reducción M-H			262 Ampliación/reducción H-H					
			125	150	200	110	120	150	175	200	
125	17,20 €	19,51 €	36,50 €			40,03 € 34,79 €					
150	19,22 €	23,47 €	39,26 €	41,27 €		36,75 €			40,03 €		
180	22,25 €	24,72 €	42,56 €		40,52 €		40,03 €			40,03 € 40,03 €	
200	25,92 €	25,86 €	42,56 €			40,03 €					

					PRECIO
Descripción		Ref.	Unid.	Dimensiones	metro ó unidad
Tubo Rectangular	 374000152	501	18m	55 x 110 x 1500 mm	7,80 €
Tubo Redondo	 37400169	605	12m	Ø 100 x 1500mm	7,80 €
Tubo Redondo Flexible		688	3m	Ø 100	18,68 €
		689		Ø 127	21,82 €
Empalme Rectangular	 374000183	510	66	55 x 110 x 41mm	1,62 €
Empalme Redondo	 374000190	615	40	Ø 100 x 41mm	1,45 €
Empalme Mixto	 374000206	520	36	Ø 100 x 55 x 110mm	3,25 €
Codo Mixto	 374000213	525	45	Ø 100 x 55 x 110mm	2,83 €
Codo Rectangular Vertical	 374000220	530	70	55 x 110mm	3,01 €
Codo Rectangular Horizontal	 374000237	535	48	55 x 110mm	3,15 €
Embellecedor Pared	 374000244	540	25	55 x 110 x 143 x 143mm	1,60 €
Empalme Pared Mixto	 374000251	545	24	Ø 100 x 142 x 142mm	2,44 €
Ventanilla Salida Exterior	 374000268	550	30	Ø 100 x 140 x 142mm	3,57 €
Abrazadera Rectangular	 374000275	555	25	16 x 55 x 110mm	2,14 €
Abrazadera Redonda	 374000282	656	25	16 x 110mm	2,14 €
Aro Reductor Salida	 374000299	660	40	Ø 125 a 100mm	2,08 €
Empalme Pared Redondo-Redondo	 0374003516	565	24	Ø 100 x 142 x 142mm	2,80 €
Codo Rectangular Horizontal 45°	 374000312	570	20	55 x 110mm	2,86 €
Codo Redondo-Redondo 90°	 374000329	670	36	Ø 100	3,93 €

Ref.	Descripción	Unid	Embalaje	Dimensiones	PRECIO metro ó unidad
801 374000442	 Tubo plano rectangular	M	13,5	75 x 150 x 1500	13,85
805 374000459	 Tubo redondo	M	12	Ø 120 x 1500 Ø 150 x 1500	13,23 19,64
810 374000466	 Empalma rectangular	U	27	75 x 150	2,86
815 SU2030 374000473	 Empalme redondo	U	24	Ø 120 Ø 150	2,35 10,14
820 374000480	 Manguito Mixto	U	28	Ø 120 a 75x150	5,72
826 374000497	 Codo Mixto 90°	U	34	Ø 120 a 75x150	5,34
830 374000503	 Codo rectangular vertical 90°	U	38	90° 75 x 150	5,37
875 374002930	 Codo rectangular horizontal 45°	U	36	45° 75 x 150	5,36
835 374000510	 Codo rectangular horizontal 90°	U	24	90° 75 x 150	5,70
870 SU2075 374000599	 Codo redondo	U	22	Ø 120 Ø 150	5,19 14,79
840 374000527	 Remate pared rectangular	U	25	75 x 150	1,71
845 374000534	 Remate pared redondo	U	25	Ø 120	2,02
850 374000541	 Ventanilla salida exterior rectangular	U	20	75 x 150	6,43
852 SU2052 374000558	 Ventanilla salida exterior redonda	U	18	Ø 120 Ø 150	5,92 12,63
855 374000565	 Abrazadera rectangular	U	25	75 x 150	2,37
857 374000572	 Abrazadera redonda	U	25	Ø 120	2,36
860 SU2065 374000589	 Aro reductor	U	22	Ø 120 a 125 Ø 120 – 125 – 150	2,40 5,95
660 374000299	 Multi-cono reductor	U	40	Ø 100 a 125	2,38

	CODIGO	MEDIDAS mm	UN		PRECIO UD
 CONDUCTO RECTANGULAR	SU2002	180x90x1500	mt	12	23,61 €
 EMPALME RECTANGULAR	SU2020ES	180x90	ud	18	15,37 €
 EMPALME MIXTO	SU2040ES	150 a 180x90	ud	8	29,44 €
 CODO MIXTO VERTICAL 90°	SU2050ES	150 a 180x90	ud	6	29,43 €
 CODO RECTANGULAR VERTICAL 90°	SU2060ES	180x90	ud	11	19,26 €
 CODO RECTANGULAR HORIZONTAL 90°	SU2070ES	180x90	ud	4	23,95 €
 CODO FLEXIBLE RECTANGULAR	CCF-900ES	180x90	ud	4	43,30 €
 ABRAZADERA RECTANGULAR	SU2110	180x90	ud	25	7,11 €
 VENTANILLA SALIDA EXTERIOR	SU2100	180x90	ud	9	11,18 €
 TUBO FLEXIBLE RECTANGULAR	PR-900/6	180x90x6000	ud	10	149,66 €

Complementos accesorios tubo campana

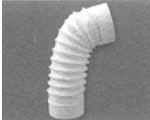
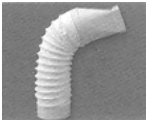
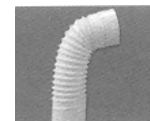
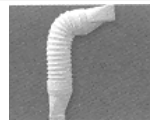
CRF-120-C	0374003445		Codo Redondo Flexible	U	4	Ø 120 L=500	21,11
CMF-120-C	0374003785		Codo Redondo Flexible Mixto	U	4	Ø 120 a 75x150 L=500	19,77
CRF-100-C	0374003430		Codo Redondo Flexible	U	8	Ø 100 L=500	13,61
CCF-500-C	0374003411		Codo Rectangular Flexible	U	8	55x110 L=500	24,01

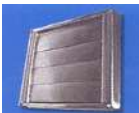
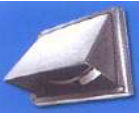
FU2053		Ventanilla INOX	U	3	Ø 150	94,19
FU2055		Ventanilla INOX	U	3	Ø 150	76,56
FU2056		Ventanilla INOX	U	3	Ø 150	98,77

TUBOS



	Unión	Material	Referencia	Medidas en mm.	uds/ caja	PVP €/ud
 <p>Tubo Flexible</p> <p>Se suministra sin junta. Instalar con pendiente ascendente mínima de 30°. Calculo Perdida de carga: 1mt flexible = 2mt tubo rígido.</p>	Macho Hembra	PP	8FLEX5	Ø80	Rollo 20m	191,25 €
			8-500MH5	Ø80x500	10	6,43 €
			8-1000MH5	Ø80x1000	10	9,18 €
			8-2000MH5	Ø80x2000	6	15,91 €
			8-3000MH5	Ø80x3000	12	20,20 €



NOTA IMPORTANTE

Respetar inclinación mínima de 3° (5,2%) ascendente en instalaciones horizontales de conductos de evacuación de humos en polipropileno para aparatos a condensación. (Norma EN 123001: 2009, Apdo 5.5.1).



CODOS

 <p>Codo 90° Macho Hembra</p>	Macho Hembra	PP	8-90MH5	Ø80	10	6,32 €
 <p>Codo 45° Macho Hembra</p>	Macho Hembra	PP	8-45MH5	Ø80	10	5,92 €



AMPLIACIONES

 <p>Ampliación Macho Hembra</p>	Macho Hembra	PP	8AMPMH5	Ø60x80	6	8,16 €
			810AMPMH5	Ø80x100	1	9,18 €
			811AMPMH5	Ø80x110	1	25,50 €
			8125AMPMH5	Ø80x125	1	31,62 €

RECOGE CONDENSADOS

 <p>T Recoge Condensados</p>	Macho Hembra	PP	8TE5	Ø80	1	24,00 €
 <p>Manguito Recoge Condensados Macho Hembra</p>	Macho Hembra	PP	8RCMH5	Ø80	1	23,00 €

ADAPTADORES BIFLUJO COMPATIBLES

Saunier Duval, Vaillant		PP	8ADSDVAP15	Ø80	1	40,80 €	
Junkers			8ADBJKP15	Ø80	1	57,00 €	
Viessman			8ADBV15	Ø80	1	56,10 €	
Beretta			8ADBBEP15	Ø80	1	56,10 €	
Ferrolli, Biasi, Fagor, Hermann, Etc.		PP	8MADBSIS	Ø80	1	30,60 €	
Baxi			8MADDBA5	Ø80	1	40,80 €	
Immergas			8MADBIMM5	Ø80	1	20,40 €	
Radiant			8MADDBRA5	Ø80	1	15,30 €	
Ariston Chaffoteaux		PP	8MADBAR5	Ø80	1	15,30 €	

INSPECCIONES

Toma de Muestras		EPDM negro	TMEPDM		1	6,12 €	
Manguito Con Toma de Muestras Macho Hembra	Macho Hembra	PP	8TM5	Ø80	12	13,26 €	

COMPLEMENTOS

Junta para Tubo Flexible		EPDM labrada	8JT6	Ø80	10	1,02 €	
Abrazadera a Pared		Acero pintado Blanco	8ABPRP3	Ø80	25	2,59 €	

CONDUCTOS DE EVACUACIÓN DE HUMOS Y GASES

CONDENSACIÓN COAXIAL

Ø60/100

CARACTERÍSTICAS

Conducción de humos en aparatos de condensación cámara Estanca
Característica básica autoextinguible
Facilidad para la toma de muestras
Diversidad de adaptadores a caldera

Combustible

Gas

Temperatura

Max. 120°C

Materiales

Tubería coaxial de Aluminio (cond. exteriores) y PPs (conductos interiores) pintada en poliéster blanco

Juntas

EPDM

CERTIFICACIONES

Productos conformes con las normativas RGLD, RITE, EN 14471 y otras normativas vigentes, homologado CE y certificado.

	IMAGEN	DESCRIPCIÓN	MATERIAL	UNIÓN	REFERENCIA	MEDIDAS (mm)	UDS/CAJA	PVP €/UD
TUBO		Tubo condensación coaxial Macho Hembra	PPs - Al	Macho - Hembra	TCOMH20100	Ø60/100 x200	6	11,95
					TCOMH50100	Ø60/100 x500	6	15,59
					TCOMH100100	Ø60/100 x1000	1	21,81
					TCOMH200100	Ø60/100 x2000	6	44,56
					TCOMH300100	Ø60/100 x3000	6	66,14
CODOS		Codo 45º condensación coaxial Macho Hembra	PPs - Al	Macho - Hembra	CCOMH45100	Ø60/100	1	18,97
			Codo 90º condensación coaxial Macho Hembra	PPs - Al	Macho - Hembra	CCOMH90100	Ø60/100	1
RECOGE CONDENSADOS		Manguito condensación coaxial con Recogida de Condensados	PPs - Al	-	COMB-C-4.2	Ø60/100	1	45,5
ADAPTADORES SALIDAS VERTICALES		Salida vertical Ø60-100 compatible Ferroli compatible ACV	PPs - Al	-	ADAPCD61FAG	Ø60-100	1	44,21
		Salida vertical Ø60-100 compatible Baxi	PPs - Al	-	ADAPCD61BA	Ø60-100	1	42,17
		Kit tramo final horizontal condensación coaxial (tubo medio metro Macho Macho + deflector)	PPs - Al	-	KIT-TFC-100CD	Ø60/100	1	22,64
ACCESORIOS		Rosetón EPDM Blanco para exterior e interior	EPDM en blanco	-	ROS100EPDM	Ø100	6	2,31
		Brida fijación con tuerca M6	Chapa de acero pintado en blanco	-	BR1100T	Ø100	25	2,04

Zeus NOX

Calentador estanco bajo

El nuevo calentador de cámara de combustión estanca **ZeusNOX** es el perfecto equilibrio entre el máximo respeto al medio ambiente, el mejor confort y la máxima seguridad.

Máximo respeto al medio ambiente, gracias a las bajas emisiones de gases contaminantes, solo 47 mg/kwh de emisiones de NOX, cumpliendo ampliamente los límites legales establecidos por la ERP europea.

Confort, gracias al sistema de modulación termostática de gas y su potente electrónica (con tres sistemas de funcionamiento: NORMAL, ECO, AUTO) proporciona la máxima precisión en la temperatura del agua caliente independiente al caudal demandado.

Seguridad, gracias a la cámara de combustión estanca con control de salida de gases por medio de ventilador autoajustable según potencia de quemador.



Máximo Rendimiento
Ventilador autoajustable en velocidad



Perfecta gestión electrónica de control de temperatura, tanto de entrada como de salida.



Selector multifunción: Normal, Automático o ECO



Sistema termostático de modulación de temperatura



Control electrónico de temperatura



Ajuste automático de velocidad del ventilador



Apto para apoyo solar



Display led digital



8 sistemas de seguridad



Tamaño reducido



Incluye kit evacuación estándar

Referencia	Caudal Litros	Versión	Tipo Gas	Dimensiones mm Alto x Ancho x Fondo	EAN	€
CCZEUSNOX12B	12	Estanco	Butano/Propano	570 x 345 x 153	8432079059764	440,00
CCZEUSNOX12N	12	Estanco	Natural	570 x 345 x 153	8432079059771	

*Incluye accesorios de evacuación estándar

22/12/2020



CRONOS
10L

Calentador Atmosférico

Bajo NOX

Termostático

Encendido automático bajo demanda de A.C.S.
Alimentación por batería (2 x 1,5V)
Control electrónico de temperatura – Termostático
Facilidad de manejo (3 pulsadores táctiles)
Display indicador de temperatura y códigos de averías
5 controles de seguridad
Incluye accesorios de instalación



Referencia	Caudal Litros	Versión	Tipo Gas	Dimensiones mm Alto x Ancho x Fondo	EAN	€
						350,00
CCCONOS101IB	10	Atmosférico Low NOX	Butano/Propano	636 x 350 x 225	8432079803134	350,00
CCCONOS101IN	10	Atmosférico Low NOX	Natural	636 x 350 x 225	8432079830141	

Nº 20

03



CALDERAS DE CONDENSACION



KOMBI KOMPAKT HR

Nº DE ARTICULO	MODELO	GAS	CAUDAL(T=30)	POTENCIA KW (KCAL)
47707	HR 28/24	N G20	12.5 l/min	26.3 (22.618)
47717	HR 36/30	N G20	15.0 l/min	30.3 (26.058)

PRECIO(€)
1.916,00
2.144,00



La caldera de alto rendimiento KOMBI KMPAKT es muy compacta y cabe en el espacio más reducido. Las posibilidades de conexión son casi ilimitadas. Según cada situación se pueden realizar las conexiones necesarias utilizando los kits de conexión superiores e inferiores. También debido a la gran longitud permitida de los conductos de suministro de aire de evacuación de gases de combustión (juntos hasta 80m) resulta fácil de instalar. Las calderas son configurables como caldera mixta, solo calefacción ó solo agua caliente, además permiten realizar instalaciones con paneles solares y suelo radiante.

DESCUENTO 3% POR LA COMPRA DE 2 ó MAS CALDERAS

>>Ventajas Principales

- Abundante producción de agua caliente sanitaria.
- Alto rendimiento en calefacción y ACS.
- Un ahorro en el consumo de gas hasta del 30%.
- Reducidas emisiones contaminantes (CO y Nox).
- Cámara de combustión estanca.
- ACS instantánea e ilimitada.
- Apta para gas natural, propano y butano.
- Apta para suelo radiante y energía solar térmica.
- Encendido electrónico (sin llama piloto).
- Sencilla instalación.
- Panel digital con auto diagnóstico.
- Mínimo nivel sonoro.
- Bajo coste de mantenimiento.
- Sistema de temperatura modulante.
- Intercambiador de calor de aluminio con dos circuitos independientes de cobre.
- Configurable como caldera mixta, solo calefacción o solo ACS.
- Excelente conducción de calor, que reduce la calcificación.
- Sin válvula de 3-vías.
- El tubo de evacuación de gases de combustión puede tener una longitud de hasta de 80 metros.
- 15 años de garantía en el intercambiador de calor.
- 2 años de garantía en los demás componentes. (5 años con contrato de mantenimiento con un SAT oficial)

BLUEHELIX PRO SLIM

MICROACUMULACIÓN

Caldera mural mixta de condensación

2 años garantía **TOTAL**



Ferrolli



PRECIO

1.165,00 €

FONDO DE
250mm

- **Fondo reducido para integración en cualquier espacio.**



- **Nivel sonoro por debajo de 50dB: Máximo confort.**



- **Caldera ecológica no contaminante: menor emisión de CO₂ y NOx (NOx: 80% menos que las calderas estándar)**

27 kW
MICROACUMULACIÓN

- **Gran producción de agua caliente sin esperas.**

BLUEHELIX PRO SLIM

MICROACUMULACIÓN

Caldera mural mixta de condensación

OTRAS PRESTACIONES

- Gama disponible en 27 kW y 32 kW.
- Calderas especialmente diseñadas para instalaciones de energía solar térmica.
- Máximas prestaciones en A.C.S., hasta 18,3 litros/min.
- Posibilidad de conexión de sonda exterior directamente a caldera.

AMPLIAS POSIBILIDADES DE INCORPORAR ELEMENTOS DE REGULACIÓN:

- Ahorros del 15% al incorporar la conexión de un Cronocomando y Sonda Externa Ferroli (consultar catálogo general).



ACCESORIOS OPCIONALES SOLARES:



Kit solar con intercambiador de placas: independiza los circuitos primarios de solar y secundario de consumo de A.C.S.



Plantilla hidráulica con válvula mezcladora termostática incorporada.

Bluehelix Pro Slim

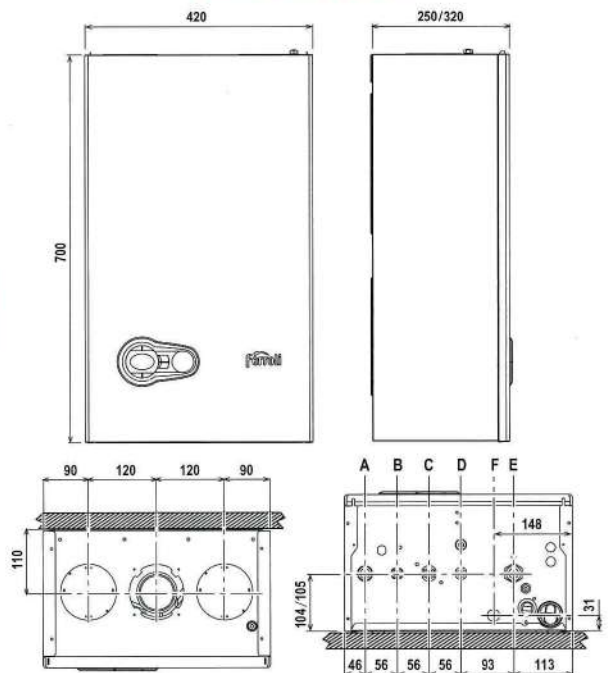

DATOS TÉCNICOS BLUEHELIX PRO S C

Bluehelix Pro S C		27		32		
		P. máx.	P. mín.	P. máx.	P. mín.	
Calefacción	Gasto Calorífico	kW	25	5,8	29,5	6,7
	Potencia Térmica útil con 80°C-60°C	kW	24,5	5,7	28,9	6,6
	Potencia Térmica útil con 50°C-30°C	kW	26,5	6,2	31,3	7,2
	Rango de trabajo	°C	30-90		30-90	
	Presión máxima de trabajo	bar	3		3	
	Válvula de seguridad	bar	3		3	
	Presión mínima de trabajo	bar	0,8		0,8	
	Capacidad vaso expansión	litros	8		10	
	Presión precarga vaso expansión	bar	1		1	
	Contenido de agua en la caldera	litros	1,7		2,1	
Sanitario	Potencia térmica útil	kW	27	5,7	32	6,7
	Rango de trabajo	°C	40-65		40-65	
	Presión máxima de trabajo	bar	9		9	
	Presión mínima de trabajo	bar	0,3		0,3	
	Producción A.C.S con AT 25°C	litros/min	15,5		18,3	
	Producción A.C.S con AT 30°C	litros/min	12,9		15,3	
Rendimiento	Clasificación en Sanitario según EN 13203		***			
	Rendimiento con 80° - 60°C	%	98	97	98	97,8
	Rendimiento con 50° - 30°C	%	105,2	107	106,1	107,5
	Rendimiento a carga parcial 30% Pot.Máxima	%	108,8		108,8	
	Clase eficiencia energética	Calefacción	A		A	
Combustión	Clase de emisión NOx, según EN 297/A-EN 483		5		5	
	Temperatura gases quemados 80°C - 60°C	°C	65	60	65	60
	Temperatura gases quemados 50°C - 30°C	°C	43	31	43	31
	Caudal de gases quemados	kg/h	36,6	13,6	43,2	15,8
	Cantidad de condensados	kg/h	2,82	1,46	3,33	1,73
	Valor ph del agua de condensados	pH	4,1		4,1	
	Máxima potencia absorbida	W	71		90	
Alimentación eléctrica	Índice protección eléctrica	IP	X5D		X5D	
	Peso	kg	30		31,5	
CÓDIGO*	Natural		695000254		695000324	
	(Solo caldera) Propano		695000253		695000323	

PANEL DE MANDOS DIGITAL



- 1 Display LCD.
- 2 Selector regulación sanitario.
- 3 Selector ON-OFF y modalidad confort.
- 4 Hidrómetro.
- 5 Selector regulación calefacción.
- 6 Reset/selector verano-invierno.

DISTRIBUIDO POR:



Ferrolí

Nº 22 03



ALTAIR

CALDERAS

REFERENCIA	MODELO	Potencia útil Kcal/H (Kw)	Tipo	Gas	Dimensiones Alto x Ancho x Fondo	PRECIO €
1017435140	ALTAIR	24.000 (28)	Estanca	Butano / Prop.	720 x 430 x 330	830,00
1017434140	HK C 228			Gas Natural		

ELITE CONDENS

Biasi presenta la nueva caldera de condensación premezcla: Elite Condens está diseñada para garantizar la máxima eficiencia en el mínimo espacio. Elite Condens se caracteriza por ser la caldera ideal para instalaciones tanto de suelo radiante como de radiadores; por ser la caldera de condensación más compacta que asegura un alto rendimiento, bajo consumo y respeto por el medio ambiente. Elite Condens está disponible con potencia de 25 kW y de 35 kW, para calefacción y producción de A.C.S.

TAMAÑO COMPACTO

Elite Condens está entre las calderas más compactas de su categoría. Su estética innovadora y sus dimensiones compactas (700x400x290) hacen que sea la caldera ideal para cualquier tipo de instalación (nueva obra y reposición). La polyvalencia de Elite Condens permite al instalador adaptar la caldera en cualquier tipo de instalación: desde instalaciones de pequeñas dimensiones (apartamentos) regulando la potencia máxima necesaria, a instalaciones de mayor superficie (chalets), garantizando hasta una potencia útil de 34,1 kW.

ALTO RENDIMIENTO

La caldera de premezcla debe su alto rendimiento a:

- 1 El intercambiador de condensación, que consigue recuperar el calor latente de los humos.
- 2 El quemador premezcla total, que reduce el exceso de aire y aumenta el porcentaje de CO₂, bajando la temperatura de expulsión de humos.

En el campo estequiométrico, la temperatura de condensación del vapor de agua es de unos 56°C; Elite Condens puede trabajar a alta y baja temperatura: Cuando trabaja a alta temperatura, ofrece un rendimiento aproximado del 98%, gracias a la combustión premezcla. Sin embargo, cuando trabaja a baja temperatura, Elite Condens da un rendimiento aproximado del 108%, gracias a la recuperación de calor en la condensación y a la reducción de la pérdida de carga debido a la baja temperatura de los humos. Por reducir los consumos y aumentar la eficiencia, Elite Condens diferencia la potencia útil en A.C.S. y calefacción: el objetivo es garantizar siempre la cantidad justa de calor que consiste en evitar el derroche optimizando el funcionamiento de la instalación y garantizando el confort demandado.

ALTO RESPETO AL MEDIO AMBIENTE

El quemador premezcla en acero INOX, asociada a la alta tecnología de la condensación, garantiza el máximo respeto al medio ambiente. Elite Condens está diseñada y fabricada para que cumpla todos los requisitos necesarios según la directiva europea EN297: Caldera de bajo Nox, clase 5.



CE 0694 Certificado CE
Alto rendimiento 5 estrellas dir. rend. 92/42 CEE
Caldera de bajo Nox, Clase 5*

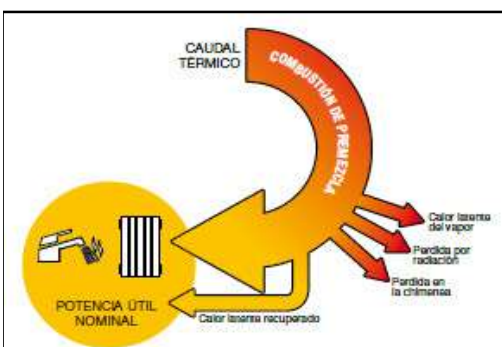

Caldera BIASI Elite Condens 25 Kw

OFERTA... 1.436,67 €

20/09/2022

ACCESORIOS DE EVACUACIÓN ESTANCA ALUMINIO COAXIAL 60/100

	Descripción	Referencia	PRECIO
	Tubo 500 mm	8506 200 381	23,22 €
	Tubo 1000 mm	8506 200 382	33,98 €
	Codo M-H 90°	8506 200 385	28,34 €
	Codo H-H 90°	8506 200 389	28,34 €
	Codo M-H 45°	8506 200 384	28,44 €
	Manguito Union H-H	8502 218 668	12,05 €
	Salida Vertical 60/100	8502 186 616	33,18 €
	Salida Techo 60/100		33,18 €
	Recogida de condensados	3003 200 389	34,66 €

ACCESORIOS DE EVACUACIÓN FORZADA

	Descripción	Referencia	PRECIO
	Kit Tiro Forzado Ø 110 mm	KITFORZADO	138,31 €
	Kit Tiro Forzado Ø 125 mm	COVALL25400	140,94 €



MEDITERRÁNEO.2

TERMO ELÉCTRICO RESISTENCIA BLINDADA

Termo eléctrico de elevadas prestaciones, de construcción robusta y duradera, respetuoso con el medio ambiente empleando aislamiento de un eficaz poliuretano de alta densidad libre HCFC.

Nuevo sistema de protección anticorrosiva mediante ánodo de magnesio independiente de la resistencia, ampliando su campo de acción y efectividad

Control de temperatura regulable exterior Excepto modelo Horizontal	Protección anticorrosión por ánodo de magnesio	Protección antiheladas ↑↑↑↑	Aislamiento de poliuretano 100% libre de HCFC
Recubrimiento del depósito de esmalte porcelánico vitrificado	Resistencia blindada de alto rendimiento	Termostato de seguridad	Accesorios suministrados: válvula de seguridad, manguitos electrolíticos y sistema de fijación

REFERENCIA	LITROS	INSTALACION	POTENCIA	DIMENSIONES (mm)		PRECIO
			W	Longitud	Ø	€
CCV030MED2	30	Vertical	1200	460	370	142,50
CCV050MED2	50	Vertical	1500	510	460	160,00
CCV060SLIMMED2	60 Slim	Vertical	1500	850	370	173,33
CCV080MED2	80	Vertical	1500	700	460	188,50
CCV100MED2	100	Vertical	1500	805	460	210,17
CCVH080MED2	80	Horizontal	1500	700	460	195,00
CCV100MED2	100	Horizontal	1500	805	460	227,50

GARANTIA DEPOSITO
3 AÑOS

CCV150BALNEW	150	Vertical	2 x 1000	1415	460	431,17
CCV200BALNEW	200	Vertical	2 x 1000	1255	586	550,00

GARANTIA DEPOSITO
5 AÑOS

VERTICAL

HORIZONTAL

Modelo		30	50	60	80	100	150	200
Capacidad	L	30	50	60	80	100	150	200
Potencia	W	1200	1500	1500	1500	1500	2000	2000
Voltaje	V	220/240	220/240	220/240	220/240	220/240	220/240	220/240
Frecuencia	Hz	50/60	50/60	50/60	50/60	50/60	50/60	50/60
Presión Nominal	Bar	7,5	7,5	7,5	7,5	7,5	7	7
Presión Máxima	Bar	8,5	8,5	8,5	8,5	8,5	8	7
Presión Ensayo	Bar	12	12	12	12	12	14	14
Regulación Temperatura	°C	25-75	25-75	25-75	25-75	25-75	25-75	25-75
Conexiones Hidráulicas		1/2"	1/2"	1/2"	1/2"	1/2"	1/2"	1/2"
Peso	Kg	12	17	19	23,5	28	40	49
Ánodo Magnesio		Si	Si	Si	Si	Si		
Ánodo Magnesio con Test							Si	Si

	80	100
Capacidad	75	99
Potencia	1500	1500
Voltaje	220/240	220/240
Frecuencia	50/60	50/60
Presión Nominal	7,5	7,5
Presión Máxima	8,5	8,5
Presión Ensayo	12	12
Regulación Temperatura	25-75	25-75
Conexiones Hidráulicas	1/2"	1/2"
Peso	23	27
Ánodo Magnesio	Si	Si



SERIE ELLITE

Onix Connect



En la
CUBA

5
AÑOS

GARANTIA
En componentes si
el usuario se
registra en la web
de Thermor

2
AÑOS

**GARANTIA
TOTAL**

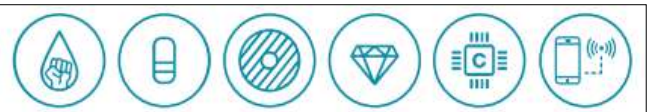

MODELO	POTENCIA W	Tensión V	DIMENSIONES (mm)				ERP	PRECIO
			H	A	B	C		
ONIX CONNECT 30	1000 / 1000	230	590	435	280	155	B	334,75 €
ONIX CONNECT 50	1500+750/1000	230	765	610	500	155	B	379,04 €
ONIX CONNECT 80	1500+750/1000	230	1130	975	700	155	B	462,47 €
ONIX CONNECT 100	1500+750/1000	230	1340	1185	800	155	B	506,76 €

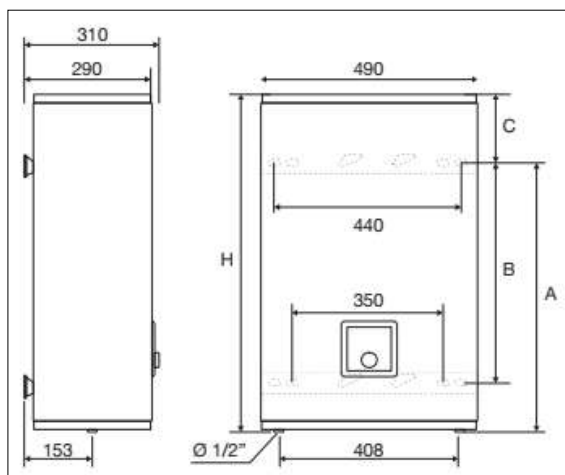

DURABILIDAD

- Doble cuba vitrificada
- Doble resistencia cerámica envainada con baja tasa de carga para todo tipo de agua

AHORRO ENERGÉTICO

- Aislamiento térmico de alta densidad
- Sistema BriseJet para una estratificación óptima del agua
- Termostato electrónico
- Visualización del consumo de agua y electricidad

GARANTÍA

- Garantía de 7 años en la cuba y 5 años en componentes eléctricos
- 2 años de garantía total

CONFORT



- Display digital táctil
- 4 modos: Manual/ECO+/Ausencia/Boost

FACILIDAD DE INSTALACIÓN

- Formato multiposición vertical u horizontal
- Incluye de serie placa de montaje
- Diseño extraplano, ideal para espacios reducidos



BALI

-  Depósito vitrificado con esmalte porcelánico
-  Doble resistencia envainada
-  Protección antical por ánodo de magnesio
-  Portavainas vitrificado
-  Tecnología SMART
-  Control digital de temperatura





-  Protección contra sobrecalentamiento
-  Protección antiheladas
-  Función automática antilegionela
-  Aislamiento de poliuretano libre de HCFC
-  Instalación multiposición
-  Accesorios incluidos







	REFERENCIA	LITROS	INSTALACION	POTENCIA W	DIMENSIONES (mm)		PRECIO €
					Longitud	Ø	
A	CCV030BALI	30	Vertical/Horizontal	2 x 1000	658	365	228,14
B	CCV050BALI	50	Vertical/Horizontal	2 x 1000	920	365	252,65
B	CCV080BALI	80	Vertical/Horizontal	2 x 1000	882	460	316,86
B	CCV100BALI	100	Vertical/Horizontal	2 x 1000	1045	460	337,14
C	CCV150BALI	150	Vertical/Horizontal	2 x 1000	1410	460	528,10



TÁNDEM

-  Display digital
-  Termo extraplano con doble depósito esmaltado
-  Biposicional (vertical y horizontal)
-  Tecnología SMART
-  Sistema ECO para ahorro de energía

-  Protección automática antiheladas
-  Protección antical con doble ánodo de magnesio
-  Sistema automático antibacteriano
-  Incluye los accesorios de instalación



	REFERENCIA	LITROS	INSTALACION	POTENCIA W	DIMENSIONES (mm)			PRECIO €
					Longitud	Ø		
B	CCV030TANDEM	30	Vertical/Horizontal	1800	575	516	308	253,49
B	CCV050TANDEM	50	Vertical/Horizontal	1800	804	516	308	304,19
B	CCV080TANDEM	73	Vertical/Horizontal	1800	1009	556	328	380,24
B	CCV100TANDEM	92	Vertical/Horizontal	1800	1219	556	328	421,64

Valvulas Esfera Gas



Automática con muelle

CODIGO	Ø	REFERENCIA	UN	PRECIO
	1/2"	36.080	12	4,65 €
	3/4"	36.081	12	7,65 €
	20x150	36.083	12	4,90 €

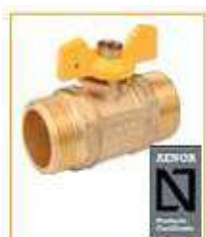

Mariposa roscar M-M

CODIGO	Ø	REFERENCIA	UN	PRECIO
	1/2"	36.050	12	4,97 €
	3/4"	36.051	12	6,02 €
	1"	36.052	6	9,25 €
	1¼"	36.053	6	13,30 €



Palanca roscar M-M

CODIGO	Ø	REFERENCIA	UN	PRECIO
	1/2"	36.040	12	4,97 €
	3/4"	36.041	12	6,02 €
	1"	36.042	6	9,25 €
	1¼"	36.043	6	13,30 €
	1½"	36.044	2	20,35 €
	2"	36.045	1	32,13 €
	2½"	36.046	1	59,82 €

Paso Total (No certificada)

	3/4"	36.048	12	7,80 €
--	------	--------	----	--------

Contador escuadra mariposa



CODIGO	Ø	REFERENCIA	UN	PRECIO
	3/4"	36.077	6	8,70 €
	7/8"	36.075	6	9,17 €
	1¼"	36.076	6	20,62 €

Contador recto mariposa



CODIGO	Ø	REFERENCIA	UN	PRECIO
	3/4"	36.067	6	7,90 €
	7/8"	36.065	6	8,32 €
	1¼"	36.066	6	18,72 €

LIRAS GLP



► Materiales



DN7 LIRAS GLP

- A. Latón
- B. PE
- C. Acero inoxidable
- D. NBR
- E. NBR

- ⊗ Diámetro exterior: 15,5 mm
- ⊗ Diámetro interior: 7 mm
- ⊗ Presión de trabajo: 20 bar



Racorería	L	PRECIO
Hembra 21,8 Izquierda	500	9,98 €
Hembra 20 x 1,5 Derecha	720	11,22 €



	DIAMETRO	ENVASE	PRECIO
LLAVE DE GAS ERMETO	10	12	9,97 €
	12	12	11,07 €
LLAVE DE GAS SOLDAR	10	24	10,70 €
	12	24	12,05 €
	15	12	9,55 €
TUERCA ERMETO	10	50	0,69 €
	12	50	0,71 €
BICONO LATON	10	50	0,26 €
	12	50	0,32 €
BRIDA CROMODA ABS	10	50	1,05 €
	12	50	1,05 €
ABRAZADERA METALICA	16 x 18	100	0,65 €

Envase completo

5%

Descuento



MANGUERA DE BUTANO	60 metros	1,29 €
--------------------	-----------	--------



RPB-50



RPB-30

CARACTERÍSTICAS TÉCNICAS

Presión nominal: 50 mbar
 Caudal garantizado: 2,5 Kg/h
 Tipo de gas: GLP - B/P
 Presión de alimentación: 0,3 - 16 bar
 Presión de cierre: 63 mbar
 Conexión de entrada: G-56 (UNE-EN 12864)
 Conexión de salida: H-51 (UNE-EN 12864)

RECOMENDACIONES DE USO

Presión de salida: 50 gr/cm²
 Regulador para cocinas que demandan más potencia de gas: restaurantes, tapperías, bares, ...
 Serie semi-industrial para hostelería.
 Nismo caudal a diferentes presiones.
 Un fuego más y calienta mas rápido.

UN	PRECIO/UN
12	14,52 €

CARACTERÍSTICAS TÉCNICAS

Presión nominal: 29 mbar
 Caudal garantizado: 2,5 Kg/h
 Tipo de gas: GLP - B/P
 Presión de alimentación: 0,3 - 16 bar
 Presión de cierre: 40 mbar
 Conexión de entrada: G-56 (UNE-EN 12864)
 Conexión de salida: H-51 (UNE-EN 12864)

RECOMENDACIONES DE USO

Presión de salida: 30 gr/cm²
 Regulador de gas clásico, el de siempre.

UN	PRECIO/UN
12	11,64 €
50	10,95 €



	DIAMETRO	ENVASE	PRECIO
UNION	10	25	2,74 €
	12	25	3,14 €
UNION REDUCIDA	12 - 10	25	3,16 €
RACOR REDUCCION	10 - 1/2"	25	2,43 €
	12 - 1/2"	25	2,54 €
BOQUILLA	10	25	1,98 €
	12	25	2,32 €
CODO	10	25	3,79 €
	12	25	4,52 €
TE	10	25	5,19 €
	12	25	5,91 €
DERIVACION TE	10	25	4,10 €
CONJUNTO PARA LLAVE GAS SOLDAR	10	25	1,69 €
	12	25	1,96 €
RACOR PARA REGULADOR DE ROSCA	6		3,36 €

Envase completo

5%

Descuento

	DIAMETRO	ENVASE	PRECIO
	10	25	0,81 €
	12	25	0,85 €
UNION REDUCIDA	12 - 10	25	0,90 €
	10	25	0,74 €
	12	25	0,75 €
	10	25	1,79 €
	12	25	2,08 €
	10	25	2,12 €
	12	25	2,46 €
	10	25	2,89 €
	10	25	6,63 €
	10	100	0,48 €
	12	100	0,48 €
		100	0,20 €

Envase completo
5%
Descuento

VALVULA SEGURIDAD CALENTADORES



Con retención
10 bar

CODIGO	Ø	UN	PRECIO
0758500407	1/2"	6	4,77 €
0758500414	3/4"	6	8,74 €



Con retención y purga
10 bar

- 1- Tornillo Seguridad Mando
 - 2- Boquilla Evacuación Sobrepresión
 - 3- Muelles Antiretorno y Alivio
 - 4- Junta Sistema Antiretorno
- Q235 LATON INOX NBR**

CODIGO	Ø	UN	PRECIO
0758500452	1/2"	6	6,47 €
0758500469	3/4"	6	9,84 €

Llaves de gas y reguladores

ASL



CARACTERÍSTICAS TÉCNICAS

Tipo de gas: GLP - B/P
Presión de alimentación: 0,3 - 16 bar
Conexión de entrada: G-56 (UNE EN 12864)
Conexión de salida: H-2 (UNE EN 12864)
Válvula antirretorno incorporada

RECOMENDACIONES DE USO

Adaptador **Paso Libre** de ¼ de vuelta.
Especial para sopletes y bombonas industriales de propano.
Sin regulación de caudal ni presión.

UN	PRECIO/UN
12	12,41 €

RSL



CARACTERÍSTICAS TÉCNICAS

Tipo de gas: GLP - B/P
Presión de alimentación: 0,3 - 16 bar
Conexión de entrada: G-56 (UNE EN 12864)
Conexión de salida: H-2 (UNE EN 12864)
Válvula antirretorno incorporada

RECOMENDACIONES DE USO

Adaptador **Paso Libre**.
Especial para sopletes, baterías de bombonas industriales de propano y soldaduras de tela asfáltica.
Regulan el caudal salida.
No regulan la presión de salida.

UN	PRECIO/UN
12	13,60 €

RPV



CARACTERÍSTICAS TÉCNICAS

Tipo de gas: GLP
Presión de alimentación: 0,3 - 16 bar
Conexión de entrada: G-56 (UNE-EN 12864)
Conexión de salida: H-2 (UNE 60408)
Presión de salida: 0-2 bar

RECOMENDACIONES DE USO

Regulador de **Presión Variable**.
Especial para paelleras y bombonas industriales de propano.
Regulación de caudal y presión en el mismo mando.

UN	PRECIO/UN
12	14,24 €

Camping



ADAPTADOR DE USO EXCLUSIVO CON BOMBONAS DE GAS BUTANO de Repsol Butano

Aquí tiene su mejor compañía para salir al campo con total libertad. Con su bombona de 6kg. y este adaptador, podrá hacer barbacoas, calentar alimentos... y de la forma más cómoda y sencilla. Una vez ajustado el adaptador a la bombona, podrá enroscar los aparatos directamente a ellas así de fácil. Prepárese para disfrutar del campo como nunca.

Regulador especial para bombonas de camping-gas, etc.

UN	PRECIO/UN
12	16,95 €



0001005617

JUEGO ESCUADRAS LAVABO

ESPESOR	LONGITUD
2 mm	140 mm



01166

JUEGO TORNILLOS LAVABO (M-10)

JUEGO TORNILLOS LAVABO INOX M-10x110

JUEGO TORNILLOS WC Verticales



01174

LATON 75 mm con TACO



082573270

ACERO INOX 7 / 32 / 70



JUEGO TORNILLOS WC Laterales

50.T/02.00

BICROMATADO con TACO

LATON



JUEGO TORNILLOS WC Laterales INOX



Acero inoxidable
Stainless steel

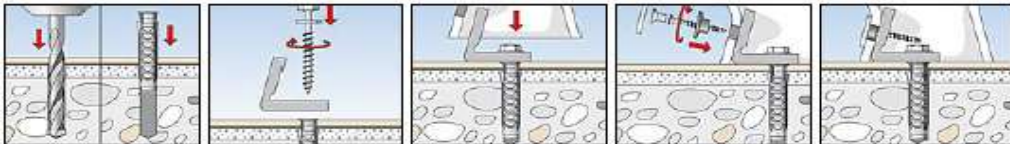

JUEGO TORNILLOS FIJACION CISTERNA AL INODORO

70.0016.01

BICROMO 110

70.0016.04

LATON 6 x 80



0386003728

ACERO INOX

ENVASE	PRECIO/UD
12	3,77 €
12	2,70 €
12	5,48 €
50	5,10 €
50	1,47 €
50	2,00 €
25	1,17 €
25	3,08 €
10 JUEGOS	4,92 €
12	2,78 €
12	4,60 €
12	3,27 €

CONEXIONES LAVADORA Y LAVAVAJILLAS



Salida Lavadora 2 tomas

Resistencia a temperaturas de -10°C a 95°C, bajo las normativas de resistencia de fabricantes de lavadora.

CODIGO	UN	PRECIO	BOLSA	
			PRECIO	PRECIO
05122000	12	5,77 €	5,91 €	

APLICACIONES:

Tubo especialmente concebido para desagüe de lavadora y lavavajillas de 1,80 metros.



Entrada Lavadora

Tubo de alimentación de lavadoras y lavavajillas.

Adaptable a racores de plástico y metal. Resistencia a la temperaturas de -10°C a 60°C.

Presión de trabajo: 12 Kg.
Presión de rotura: 46 Kg.

CODIGO	MEDIDA	UN	PRECIO	BOLSA	
				PRECIO	PRECIO
20171500	1,5 metros	12	6,12 €	7,74 €	
20172000	2 metros	12	7,56 €	9,38 €	

JUNTAS CON FILTRO



CODIGO	MATERIAL	MEDIDA	Ø	UN	PRECIO
0450013896	EPDM / METAL	14x24x3/7	3/4	20	1,41 €

ATOMIZADORES

Atomizadores Cromados



CAJA DE 60 unidades Descuento 10%

CODIGO	MEDIDA	UN	PRECIO
126-55	Macho 24/100	20	2,93 €
126-50	Hembra 22/100	20	1,42 €
1B248A0	Macho 28/100	10	2,45 €

Atomizadores con Rotula Cromados



CODIGO	MEDIDA	UN	PRECIO
704324	Macho 24/100	10	4,10 €
704322	Hembra 22/100	10	4,10 €

Atomizador Fregadero 2 posiciones



CODIGO	UN	PRECIO
0792010519	12	4,60 €
	30	4,45 €

Incluye caja expositor

Atomizadores Flexibles



CODIGO	MEDIDA	UN	PRECIO	
			NORMAL	2 POSICIONES
31500	Macho 24/100	10	8,30 €	9,50 €
31400	Hembra 22/100	10	8,30 €	

ECONOMIZADORES CONSUMO DE AGUA

Kit ahorro agua **Basico** ES-501.2.00



UN	PRECIO
8	7,85 €

Caja expositor **Ahorro agua** ES-505.0.00



Características:

8x ES-501.2.00
8x ES-220.2.00
10x ES-100.2.00
2x ES-110.2.00

PRECIO
144,03 €



Aireador H24 Ahorro 50% ES-110.2.00



UN	PRECIO
20	2,32 €



Aireador M24 Ahorro 50% ES-100.2.00



UN	PRECIO
20	3,28 €

Reductor ahorro agua **Ducha** ES - 221.2.00



UN	PRECIO
8	6,63 €

ADAPTADOR GRIFERIA M24/100 x



Adaptador apto para cualquier tipo de grifería con atomizador M24/100.
Convierte la salida en una rosca macho de 3/4" pudiendo adaptar fácilmente un racor de manguera, etc.
En el interior lleva filtro atomizador.

Referencia	Medida	PRECIO
00751	M 24/100 x M 3/4"	2,21 €

ADAPTADOR GRIFERIA ENCH. RAPIDO



Adaptador apto para cualquier tipo de grifería con atomizador M24/100.
Convierte la salida en un enchufe rápido convencional pudiendo adaptar fácilmente una manguera, etc.
En el interior lleva filtro atomizador.

Referencia	Medida	PRECIO
00753	M 24/100 x Enchufe rápido	2,62 €

Grifos Lavadora

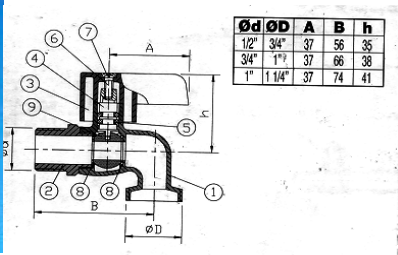

GRIFO LAVADORA CURVO

CODIGO	UN	PRECIO
758352181	24	5,30 €

GRIFO LAVADORA ESCUADRA



CODIGO	UN	PRECIO
116-25	24	3,68 €

GRIFO LAVADORA ESCUADRA CORTA



CODIGO	UN	PRECIO
00403	10	3,46 €

- Acabado cromado.
- Cierre 1/4" de vuelta.
- Fabricada en latón CW617N.
- Eje de latón.
- Juntas interiores EPDM.



GRIFO LAVADORA NORMAL Maneta PVC Cromo

CODIGO	UN	PRECIO
190-02	24	10,87 €

GRIFO LAVADORA DOBLE



2 Roscas Manetas Metálicas

CODIGO	UN	PRECIO
190-10	6	19,40 €



1 Rosca Manetas PVC

CODIGO	UN	PRECIO
190-06	6	21,26 €

GRIFO LAVADORA 2 BOCAS



CODIGO	UN	PRECIO
11554	6	8,61 €

GRIFO LAVADORA CON LLAVE DE REGULACION



CODIGO	UN	MEDIDAS	PRECIO
00406	10	1/2" x 3/4" x 3/8"	7,58 €

Valvulas Esfera

Valvula esfera palanca STH

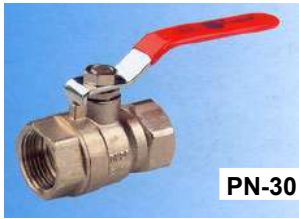

PN-30

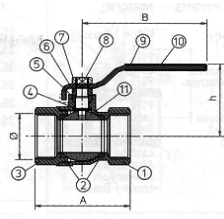

Denominación/Parts	Material
1 Cuerpo / Body	Latón / Brass
2 Junta cierre / Seat Ring	PTFE / PTFE
3 Racor / Connector	Latón / Brass
4 Arandela / Washer	PTFE / PTFE
5 Junta cónica / Sealing Joint	PTFE / PTFE
6 Prensa - estopas / Packing Gland	Latón / Brass
7 Tuercas / Nut	Latón / Brass
8 Eje / Axis	Latón / Brass
9 Maneta / Handle	Acero / Steel
10 Funda maneta / Handle coat	Plastisol
11 Bola / Ball	Latón / Brass

PALANCA		H - H		M - H	
CODIGO	MEDIDA	UN	PRECIO	PRECIO	PRECIO
F 19201	3/8"	12	2,92 €		4,78 €
F 19202	1/2"	12	3,48 €		3,26 €
F 19202	3/4"	12	5,57 €		5,87 €
F 19204	1"	12	8,28 €		9,11 €
F 19205	1 1/4"	6	12,77 €		19,23 €
F 19206	1 1/2"	4	19,26 €		28,51 €
F 19207	2"	2	29,76 €		43,63 €
F 50071	2 1/2"	1	66,14 €		
758350088	3"	1	109,26 €		

Valvula esfera palanca MT



PN-30

PALANCA
INOX

SISTEMA ANTI-HIELO

CODIGO	MEDIDA	UN	PRECIO
4095008	1/4"	12	2,92 €
4095010	3/8"	12	2,92 €
4095015	1/2"	12	5,68 €
4295020	3/4"	12	8,17 €
4295025	1"	12	12,48 €
4095032	1 1/4"	12	20,97 €
4095040	1 1/2"	6	21,48 €
4095050	2"	6	33,30 €
4095065	2 1/2"	3	63,88 €
4095080	3"	2	98,97 €
4095100	4"	1	146,47 €

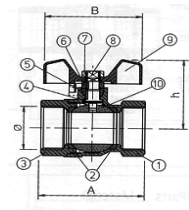

Denominación/Parts	Material
1 Cuerpo / Body	Latón / Brass
2 Junta cierre / Seat Ring	PTFE / PTFE
3 Racor / Connector	Latón / Brass
4 Arandela / Washer	PTFE / PTFE
5 Junta cónica / Sealing Joint	PTFE / PTFE
6 Prensa - estopas / Packing Gland	Latón / Brass
7 Tuercas / Nut	Latón / Brass
8 Eje / Axis	Latón / Brass
9 Mariposa / Butterfly	Aluminio / Aluminium
10 Bola / Ball	Latón / Brass

MARIPOSA H-H

CODIGO	MEDIDA	UN	PRECIO
758351207	3/8"	12	4,11 €
758351214	1/2"	12	4,72 €
758351221	3/4"	12	6,83 €
758351238	1"	12	9,81 €

MARIPOSA M-H

CODIGO	MEDIDA	UN	PRECIO
758353508	3/8"	12	4,03 €
758353515	1/2"	12	5,12 €
758353522	3/4"	12	8,07 €
758353539	1"	12	12,29 €

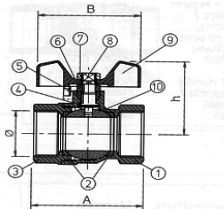

Denominación/Parts	Material
1 Cuerpo / Body	Latón / Brass
2 Junta cierre / Seat Ring	PTFE / PTFE
3 Racor / Connector	Latón / Brass
4 Arandela / Washer	PTFE / PTFE
5 Junta cónica / Sealing Joint	PTFE / PTFE
6 Prensa - estopas / Packing Gland	Latón / Brass
7 Tuercas / Nut	Latón / Brass
8 Eje / Axis	Latón / Brass
9 Mariposa / Butterfly	Aluminio / Aluminium
10 Bola / Ball	Latón / Brass

MINI H-H y M-H

PRECIO

MEDIDA	UN	Azul/Roja
1/4"	12	4,26 €
3/8"	12	4,27 €
1/2"	12	5,48 €
3/4"	12	8,76 €

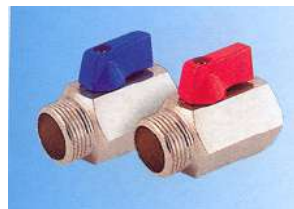
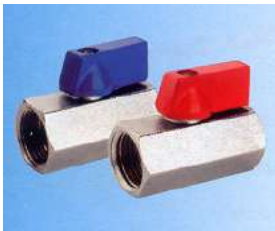

Valvulas Compuerta

VISTA

EMPO



	MEDIDA	UN	PRECIO
758300014	1/2"	12	6,28 €
758300021	3/4"	12	8,26 €
758300038	1"	12	12,04 €



	MEDIDA	UN	PRECIO
758300212	1/2"	12	13,77 €
758300229	3/4"	12	15,70 €
758300236	1"	12	19,53 €

GRIFO ESFERA DENVER PN-25

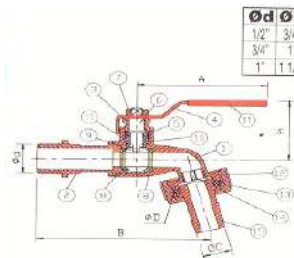

Ød	ØD	ØC	A	B	h
1/2"	3/4"	15	38	34	45
3/4"	1"	20	38	104	48
1"	1 1/4"	27	38	134	54

- 1 Cuerpo
- 2 Racor
- 3 Prensa-estopas
- 4 Maneta
- 5 Arandela
- 6 Eje
- 7 Tuerca
- 8 Juntas cierre
- 9 Bola
- 10 Junta eje
- 11 Funda maneta
- 12 Tuerca loca
- 13 Junta plana
- 14 Rompeaguas
- 15 Racor conexión

DENVER

CODIGO	MEDIDA	UN	PRECIO
758350149	3/4" - 1"	12	8,49 €
758350156	1" - 1 1/4"	6	15,35 €



SISTEMA ANTI-HIELO



GRIFO ESFERA MT JARDIN PN-16

CODIGO	MEDIDA	UN	PRECIO	
			RACOR	ENCH. RAP.
411101520	1/2" - 3/4"	12	6,27 €	7,09 €
411102025	3/4" - 1"	12	8,58 €	8,83 €
411102532	1" - 1 1/4"	10	20,74 €	
PALANCA INOX	412502532	1" - 1 1/4"	10	14,69 €

GRIFO ESFERA C/CIERRE CANDADO



Art. 007 EKO

GRIFO ESFERA RACOR MANGUERA CON CIERRE ESPECIAL SEGURIDAD CANDADO.

Serie extra fuerte. Paso total.
Construido en latón DIN-17660 cromado.
Juntas PTFE.
Montura con dos juntas tóricas.

PN-16. Temperatura máxima 100 °C.

CODIGO	MEDIDA	UN	PRECIO
113V00707	3/4" - 1"	6	30,30 €



GRIFO PORTAGOMAS PULIDO

CODIGO	MEDIDA	UN	PRECIO
792000503	1/2"	12	11,58 €
792000534	3/4"	12	16,22 €
792000541	1"	6	36,97 €

GRIFO ANGULAR BARRIL



CODIGO	MEDIDA	UN	PRECIO
08200012	1/2"	12	5,33 €

Oferta caja de 40 Uds. → 5% de descuento

VALVULA ESFERA CUADRADILLO



CUADRADILLO ROSCAR H-H
SQUARE VALVE F-F

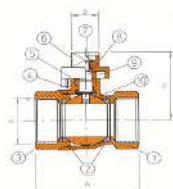

Ø	A	h
1/2"	50	42
3/4"	57	45
1"	66	50
1 1/4"	75	70
1 1/2"	90	74
2"	100	84

CODIGO	MEDIDA	UN	PRECIO
758353911	1/2"		7,57 €
758353928	3/4"		8,92 €
758353935	1"		12,34 €
758353942	1 1/4"		19,64 €

Valvulas y Grifos Esfera Inox

Grifo Curvo con cierre esférico



Estanqueidad de la esfera efectuada por una pareja de junta de teflon P.T.F.E. puro.
Estanqueidad del vástago es efectuada por una pareja de juntas de teflón de P.T.F.E. puro y una junta tórica de silicona.
Mando con palanca de acero inox con revestimiento plástico.
Límites Tª máxima: 150 °C
Límites Tª mínima: -10 °C
Presión Nominal: 25 atm.

Grifo Curvo con cierre esférico y toma rápida



MEDIDA	UN	PRECIO
1/2" x 1/2"	12	8,98 €
3/4" x 3/4"	12	12,11 €
1" x 1"	6	17,37 €

MEDIDA	UN	PRECIO
1/2" x 1/2"	12	14,95 €
3/4" x 3/4"	12	19,83 €
1" x 1"	6	27,43 €

Válvula Esfera

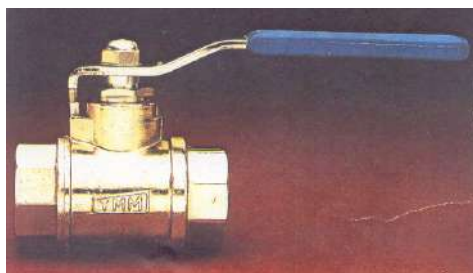
PN-60

Paso Total Hembra-Hembra
Estanqueidad de la esfera efectuada por una pareja de junta de teflon P.T.F.E. puro.
Estanqueidad del vástago es efectuada por una pareja de juntas de teflón de P.T.F.E. puro y una junta tórica de silicona.
Mando con palanca de acero inox con revestimiento plástico.
Límites Tª máxima: 200 °C
Límites Tª mínima: -30 °C
Presión Nominal: 60 atm.

MEDIDA	CANTIDAD	PRECIO
3/8"	12	12,83 €
1/2"	12	17,93 €
3/4"	12	24,29 €
1"	10	40,90 €
1 1/4"	6	66,92 €
1 1/2"	6	90,41 €
2"	4	116,66 €
2 1/2"	1	228,20 €
3"	1	321,66 €

Estas válvulas de esfera de paso total son de pérdida nula, con lo que asegura el positivo barrido de las partículas que en suspensión pudieran depositarse.

La estanqueidad del vástago y esfera es efectuada por dos parejas de juntas de teflón P.T.F.E. puro, preparadas y ajustadas con unas tolerancias mínimas.

Es idónea su utilización en distintos servicios y usos domésticos, industria, construcción, calefacción, etc.

Adecuada para trabajar con:

Vapor saturado, agua fría y caliente, aire comprimido, aceites, gas, ácidos, etc.

Por tal motivo todos los cuerpos de las válvulas, así como los restantes accesorios componentes de las mismas, se obtienen de barra de latón según DIN 17.660 y DIN 17.671, ya sean forjados (estampados), o ya mecanizados directamente en máquinas especiales.

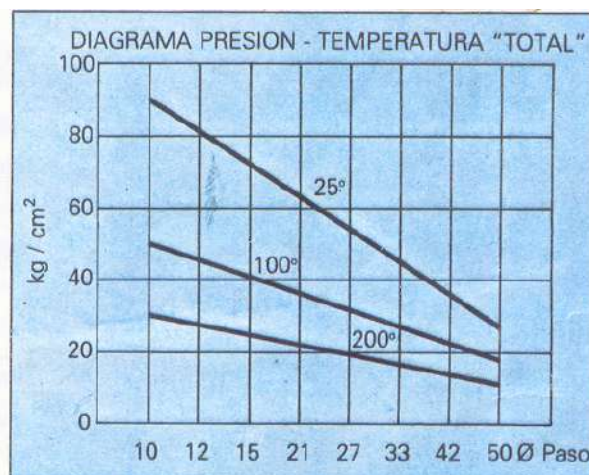

	Ø	UN	PRECIO/UN
	1/2"	20	1,18 €
	3/4"	20	1,38 €
	1"	20	1,85 €

Valvulas Esfera Inox con Retención



VALVULA ESFERA ANTIRETORNO MANETA PN-25

B110

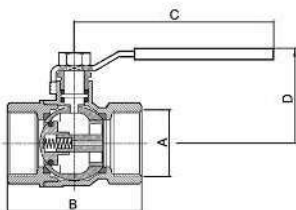

- PN 25 PASO TOTAL
- TEMPERATURA MAXIMA: 150°C
- TEMPERATURA MINIMA: -20°C
- LATON NIQUELADO DIN 17660
- MANETA ACERO INOXIDABLE AISI 304
- SALIDA: RACORD DOS PIEZAS CONEXIÓN TUBO MACHO



CODIGO	MEDIDA A	DIMENSIONES (mm)			PESO Kg	UD. x CAJA	PRECIO €
2080 01	1/2"	54	105	56	0,45	75	16,20
2080 02	3/4"	63	105	59	0,60	55	20,35
2080 03	1"	71	126	69	0,90	30	32,14
2080 04	1 1/4"	83	126	76	1,60	20	46,56
2080 05	1 1/2"	98	142	85	2,30	13	82,48
2080 06	2"	114	142	89	3,50	8	120,00

VALVULA ESFERA ANTIRETORNO MANETA PN-25

B110

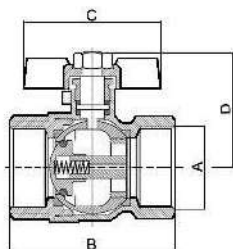

- PN 25 PASO TOTAL
- TEMPERATURA MAXIMA: 150°C
- TEMPERATURA MINIMA: -20°C
- LATON NIQUELADO DIN 17660
- MANDO MARIPOSA RECUBIERTO DE EPOXI
- SALIDA: RACORD DOS PIEZAS CONEXIÓN TUBO MACHO



CODIGO	MEDIDA A	DIMENSIONES (mm)			PESO Kg	UD. x CAJA	PRECIO €
2081 01	1/2"	54	65	56	0,45	75	16,27
2081 02	3/4"	63	65	59	0,60	55	20,35
2081 03	1"	71	65	69	0,90	30	32,14

Grifos Esfera Inox

217 R



• Con adaptador rápido

- Anti-corrosion
- Palanca y tuerca de acero inoxidable
- Palanca plana gris

MEDIDA	UN	PRECIO
1/2" x 3/4"	12	8,18 €
3/4" x 3/4"	8	11,76 €
1/2" x 3/4"	96	7,36 €
3/4" x 3/4"	64	10,58 €

217

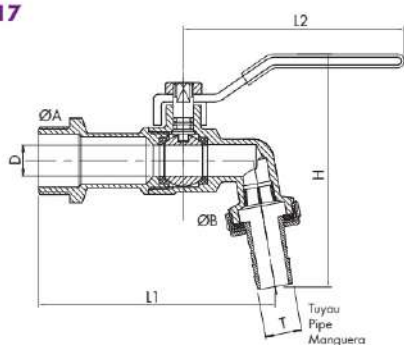

Ø A	Ø B	Kg	PN	T	D	L1	L2	H
1/2"	3/4"	0,221	16	15	9	88	81	89
3/4"	3/4"	0,280	16	15	12	95	99	95



Grifos Esfera Doble

267 R



• Con adaptador rápido

MEDIDA	UN	PRECIO
1/2"x3/4"x3/4"	12	7,74 €

267

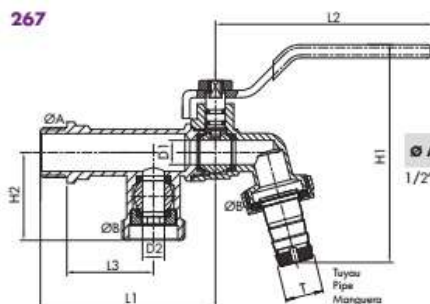

Ø A	Ø B	Kg	PN	D1	D2	L1	L2	L3	H1	H2	T
1/2"	3/4"	0,295	16	10	9	72	93	36	89	37	15

Valvulas Esfera



NEW

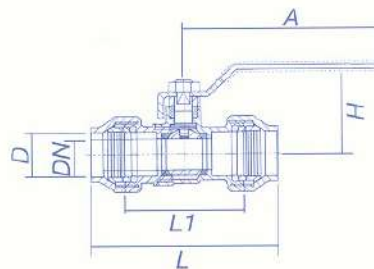

4100

MODELO STANDARD
VALVULA ESPERA PN-30
PALANCA ACERO INOX
CONEXIÓN PE x PE



CODIGO	DN			PRECIO
4100 - 020	20	42	14	10,40 €
4100 - 025	25	30	10	16,81 €
4100 - 032	32	16	8	22,15 €

L	H	A	L1	D	DN
90	41,7	95	55,6	20,8	14,5
104	43,2	95	65,6	26	19
123	51,5	127	81,7	32,5	24



NEW

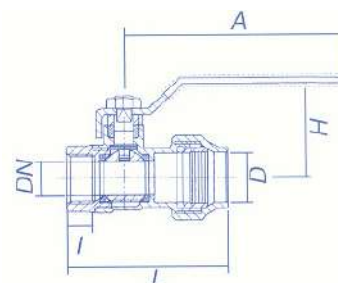

4101

MODELO STANDARD
VALVULA ESPERA PN-30
PALANCA ACERO INOX
CONEXIÓN PE x ROSCA HEMBRA



CODIGO	DN			PRECIO
4101 - 01520	1/2" x 20	48	16	7,86 €
4101 - 02025	3/4" x 25	36	12	11,88 €
4101 - 02532	1" x 32	20	10	18,83 €

L	H	A	I	D	DN
90	41,7	95	12	20,8	14,5
104	43,2	95	13	26	19
123	51,5	127	14,5	32,5	24



Construida en latón OT-58
Juntas Ptfé. Extremos soldar,
Temp. máx. 180°C

4107

VALVULA ESFERA SOLDAR PN-25
PALANCA CROMADA

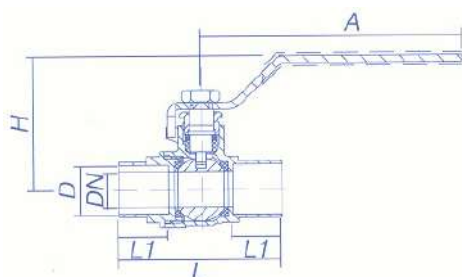

DN	PRECIO
12	6,20 €
15	6,03 €
18	6,36 €
22	10,50 €
28	16,23 €
35	30,59 €
42	33,37 €
54	42,16 €



Construida en latón OT-58
Juntas Ptfé. Extremos rosca gas.
Macho-hembra
Temp. máx. 180°C

4106

VALVULA ESFERA PN-25 CON ENLACE
MANDO PALOMILLA ROJO - AZUL
CONEXION M-H

CODIGO	DN		PRECIO
4106 - 015	1/2"	12	8,85 €
4106 - 020	3/4"	12	11,27 €
4106 - 025	32	6	18,30 €

VALVULA ACERO INOXIDABLE "316" 2 PIEZAS

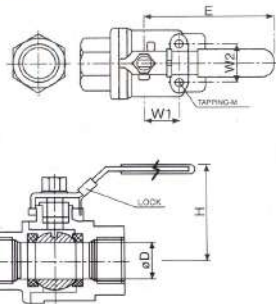

Ø	3/8"	1/2"	3/4"	1"
€	11,42	14,17	18,56	26,16

Ø	1 1/4"	1 1/2"	2"	2 1/2"	3"
€	42,02	58,39	92,09	189,18	270,34

MANGUITO ACERO INOXIDABLE H-H (Fig. 270)



Ø	1/4"	3/8"	1/2"	3/4"	1"	1 1/4"	1 1/2"	2"	2 1/2"	3"	4"
€	2,00	2,14	2,56	3,48	5,46	8,37	9,22	14,26	29,28	34,24	57,31

CODO 90° ACERO INOXIDABLE H-H (Fig. 90)



Ø	1/4"	3/8"	1/2"	3/4"	1"	1 1/4"	1 1/2"	2"	2 1/2"	3"	4"
€	1,55	1,92	2,73	4,10	6,44	9,31	12,34	20,54	34,22	55,28	97,04

TE 90° ACERO INOXIDABLE H-H (Fig. 130)



Ø	1/4"	3/8"	1/2"	3/4"	1"	1 1/4"	1 1/2"	2"	2 1/2"	3"	4"
€	2,48	3,01	4,10	6,08	9,04	11,95	16,40	26,28	49,64	80,19	116,42

MACHON ACERO INOXIDABLE (Fig. 200)



Ø	1/4"	3/8"	1/2"	3/4"	1"	1 1/4"	1 1/2"	2"	2 1/2"	3"	4"
€	1,44	1,74	2,18	2,73	5,42	6,71	8,49	13,95	24,82	34,46	51,48

TAPON ROSCA MACHO ACERO INOXIDABLE (Fig. 290)



Ø	1/4"	3/8"	1/2"	3/4"	1"	1 1/4"	1 1/2"	2"	2 1/2"	3"	4"
€	1,39	1,40	1,80	2,27	3,41	5,20	7,13	10,87	19,63	28,56	48,00

CODO 90° ACERO INOXIDABLE M-H (Fig. 92)



Ø	1/4"	3/8"	1/2"	3/4"	1"	1 1/4"	1 1/2"	2"	2 1/2"	3"	4"
€	2,10	2,54	3,30	4,93	7,13	10,88	12,34	21,07	38,31	64,85	93,28

ENTRONQUE MANGUERA ACERO INOXIDABLE (Fig. 399)



Ø	1/4"	3/8"	1/2"	3/4"	1"	1 1/4"	1 1/2"	2"
€	2,46	3,30	5,14	4,89	6,71	10,88	13,41	19,15

GRIFO BARRIL ACERO INOXIDABLE



ENVASE	PRECIO €
6	35,47

***** OFERTA ***
DESCUENTO 10%**

ACCESORIOS LATON ROSCAR-ROSCAR

CONTRARROSCA



MEDIDA	ENV.	PRECIO
1/4"	25	0,81
3/8"	25	0,63
1/2"	25	0,84
3/4"	25	1,26
1"	25	2,30
1 1/4"	10	5,00
1 1/2"	10	6,59
2"	10	9,06
2 1/2"	5	15,16
3"	2	23,30

CROMADA



MEDIDA	ENV.	PRECIO
3/8"	25	1,06
1/2"	25	1,20
3/4"	25	1,71
1"	10	2,87

CONTRARROSCA REDUCIDA



MEDIDA	ENV.	PRECIO
3/8" - 1/4"	25	1,06
1/2" - 3/8"	25	0,77
3/4" - 1/2"	25	1,43
1" - 1/2"	10	1,87
1" - 3/4"	10	2,06
1 1/4" 3/4"	10	3,79
1 1/4" - 1"	10	4,21
1 1/2" - 1"	10	5,14
1 1/2" - 1 1/4"	10	5,39
2" - 1"	5	8,60
2" - 1 1/4"	5	7,58
2" - 1 1/2"	5	8,63
2 1/2" - 2"	5	14,76

ALARGADERA CILINDRICA



CROMADA

MEDIDA	ENV.	PRECIO
1/2" x 20	10	2,55
1/2" x 50	10	4,53
1/2" x 100	10	8,51
3/4" x 50	10	7,30
3/4" x 100	10	10,72



(Fig. 526)

SU
COLOR

MEDIDA	ENV.	PRECIO
1/2" x 20	10	2,13
1/2" x 50	10	4,21
1/2" x 100	10	8,01
3/4" x 50	10	6,83
3/4" x 100	10	10,05
1" x 100	10	12,33

ACCESORIOS LATON ROSCAR-ROSCAR

ALARGADERA HEXAGONAL (Racor Marsella)



MEDIDA	ENV.	PRECIO
3/8"	25	0,58
1/2"	25	0,91
3/4"	25	1,36
1"	10	2,48
1 1/4"	10	5,07
1 1/2"	5	6,83
2"	5	10,17

ALARGADERA HEXAGONAL REDUCIDA



MEDIDA M-H	ENV.	PRECIO
3/8" - 1/2"	25	0,93
1/2" - 3/8"	25	0,91
1/2" - 3/4"	25	1,27
1/2" - 1"	10	2,30
3/4" - 1/2"	25	1,27
3/4" - 1"	10	2,10
1" - 3/4"	10	2,87
1" - 1 1/4"	10	4,29
1 1/4" - 1 1/2"	5	5,53
1 1/2" - 2"	5	10,37

ALARGADERA HEXAGONAL

MEDIDA M-H	ENV.	PRECIO
1/2" x 20	25	1,45
1/2" x 30	25	1,87

CONJUNTO TUERCA BICONO



ENV.	PRECIO
25	2,00

Tuerca compresión 3/8" tubo 10mm cromo

TAPON MACHO



MEDIDA	ENV.	PRECIO
3/8"	25	0,55
1/2"	25	0,71
3/4"	25	1,17
1"	10	1,71
1 1/4"	10	3,16
1 1/2"	5	4,40
2"	5	6,79

Normal

MEDIDA	ENV.	PRECIO
1/2"	25	0,95



5 Hilos

TAPON HEMBRA



MEDIDA	ENV.	PRECIO
3/8"	25	0,49
1/2"	25	0,62
3/4"	25	1,05
1"	10	1,64
1 1/4"	10	2,80

No 39

ACCESORIOS LATON ROSCAR-ROSCAR



REDUCCION OCULTA

MEDIDA	ENV.	PRECIO
3/8" - 1/4"	25	1,13
1/2" - 3/8"	25	1,32

REDUCCION HEXAGONO

MEDIDA	ENV.	PRECIO
1/4" - 1/8"	25	0,63
3/8" - 1/4"	25	0,63
1/2" - 1/4"	25	0,93
1/2" - 3/8"	25	0,63
3/4" - 1/2"	25	0,97
1" - 1/2"	25	1,84
1" - 3/4"	25	1,41
1 1/4" 3/4"	10	3,49
1 1/4" - 1"	10	3,25
1 1/2" - 3/4"	10	5,27
1 1/2" - 1/2"	10	5,24
1 1/2" - 1"	10	5,35
1 1/2" - 1 1/4"	10	3,91
2" - 1"	5	8,60
2" - 1 1/4"	5	8,34
2" - 1 1/2"	5	6,44
2 1/2" - 2"	5	13,47



CROMADA

MEDIDA	ENV.	PRECIO
3/4" - 1/2"	25	1,53

MANGUITO

MEDIDA	ENV.	PRECIO
3/8"	12	1,30
1/2"	12	1,49
3/4"	12	2,13
1"	12	3,16
1 1/4"	6	6,37
1 1/2"	3	8,53
2"	3	15,41
2 1/2"	3	32,19
3"	1	52,46



MANGUITO REDUCIDO

MEDIDA	ENV.	PRECIO
1/2" - 3/8"	12	1,53
3/4" - 1/2"	12	2,56
1" - 3/4"	12	2,99
1 1/4" - 1"	6	4,76
1 1/2" - 1 1/4"	3	6,87
2" - 1 1/2"	3	10,72

CURVA M-H 45°



MEDIDA	ENV.	PRECIO
1/2"	12	5,29
3/4"	6	6,59
1"	6	9,24
1 1/4"	6	14,99
1 1/2"	3	18,36
2"	3	29,39

CURVA H-H 45°



MEDIDA	ENV.	PRECIO
1/2"	12	7,30
3/4"	6	6,79
1"	6	9,57
1 1/4"	6	16,25
1 1/2"	3	21,60
2"	3	33,43

ACCESORIOS LATON ROSCAR-ROSCAR

CODO H-H



MEDIDA	ENV.	PRECIO
3/8"	12	1,56
1/2"	12	2,11
3/4"	12	3,42
1"	12	6,22
1 1/4"	6	11,53
1 1/2"	3	16,35
2"	3	24,21
2 1/2"	3	48,31
3"	1	80,76

CROMADO



MEDIDA	ENV.	PRECIO
1/2"	12	3,26
3/4"	12	6,15
1"	12	8,83

CODO M-H



MEDIDA	ENV.	PRECIO
3/8"	12	1,45
1/2"	12	2,11
3/4"	12	3,70
1"	12	6,11
1 1/4"	6	11,25
1 1/2"	3	17,09
2"	3	23,20
2 1/2"	3	59,85
3"	1	88,77

CROMADO

MEDIDA	ENV.	PRECIO
1/2"	12	4,04
3/4"	12	5,24

CODO REDUCIDO H-H



MEDIDA	ENV.	PRECIO
3/4" - 1/2"	12	4,04

CODO REDUCIDO M-H



MEDIDA	ENV.	PRECIO
3/4" - 1/2"	12	4,09
1" - 3/4"	12	6,96
1 1/4" - 1"	12	11,89

CURVA H-H



MEDIDA	ENV.	PRECIO
1/2"	12	6,04
3/4"	6	9,21
1"	6	15,35
1 1/4"	6	30,62
1 1/2"	3	36,55
2"	3	61,25

ACCESORIOS LATON ROSCAR-ROSCAR

CURVA M-H



MEDIDA	ENV.	PRECIO
1/2"	12	4,98
3/4"	6	8,06
1"	6	13,47
1 1/4"	6	26,48
1 1/2"	3	31,27
2"	3	61,39

TE



MEDIDA	ENV.	PRECIO
3/8"	12	1,87
1/2"	12	2,75
3/4"	12	3,90
1"	12	6,94
1 1/4"	6	13,29
1 1/2"	3	22,04
2"	3	33,18

TE REDUCIDA



MEDIDA	ENV.	PRECIO
3/4" - 1/2"	12	4,81
1" - 1/2"	12	6,43
1" - 3/4"	12	6,92
1 1/4" - 1"	12	17,55

TE CROMADA



MEDIDA	ENV.	PRECIO
3/8"	25	3,62
1/2"	25	3,88
3/4"	25	5,79
1"	25	9,76

CRUCETA



MEDIDA	ENV.	PRECIO
1/2"	6	4,53
3/4"	6	7,28
1"	6	12,41
1 1/4"	6	23,82
1 1/2"	3	28,93
2"	3	42,99

ACCESORIOS LATON ROSCAR-ROSCAR

RACOR 3 PIEZAS H-H



CODIGO	MEDIDA	UN.	PRECIO
792005874	1/2"	10	5,96 €
792005898	3/4"	10	9,78 €
792005911	1"	10	13,24 €
792005935	1 1/4"	5	19,92 €
792005954	1 1/2"	5	25,19 €
792005973	2"	5	29,98 €
	2 1/2"	2	89,50 €

RACOR 3 PIEZAS M-H



CODIGO	MEDIDA	UN.	PRECIO
792005881	1/2"	10	6,27 €
792005904	3/4"	10	10,02 €
792005928	1"	10	13,54 €
792005942	1 1/4"	5	21,81 €
792005973	1 1/2"	5	27,60 €
792005980	2"	5	36,56 €

RACOR CODO 3 PIEZAS H-H



CODIGO	MEDIDA	UN.	PRECIO
01251002	1/2"	10	13,47 €
01251003	3/4"	10	15,42 €
01251004	1"	10	19,32 €
01251005	1 1/4"	6	33,56 €
01251006	1 1/2"	6	42,50 €
01251007	2"	4	56,25 €

RACOR CODO 3 PIEZAS M-H



CODIGO	MEDIDA	UN.	PRECIO
01241002	1/2"	10	14,99 €
01241003	3/4"	10	17,00 €
01241004	1"	10	22,63 €
01241005	1 1/4"	5	37,85 €
01241006	1 1/2"	5	47,34 €
01241007	2"	5	61,10 €

BEBEDEROS DE CERDOS

LATON

CODIGO	UN.	PRECIO
792002415	12	3,10 €

INOX

CODIGO	UN.	PRECIO
792002439	12	6,79 €

TUERCA RACOR



CODIGO	MEDIDA	UN.	PRECIO
792002729	3/8"	25	0,41 €
792002736	1/2"	25	0,49 €
792002743	3/4"	25	0,68 €
792002750	1"	25	1,06 €
792002767	1 1/4"	25	1,64 €
792002774	1 1/2"	12	2,58 €
792002381	2"	12	4,18 €

MANGUITO ELECTROLITICO



H - H

CODIGO	MEDIDA	UN.	PRECIO
695-02	1/2"	12	1,83 €
695-03	3/4"	12	2,92 €
695-04	1"	12	4,95 €
695-05	1 1/4"	12	13,14 €
695-06	1 1/2"	12	20,77 €

MANGUITO ELECTROLITICO



M - H

CODIGO	MEDIDA	UN.	PRECIO
695-11	1/2"	12	3,20 €
695-12	3/4"	12	4,62 €

ACCESORIOS MANGUERA Y DEPOSITOS

ENTRONQUE MANGUERA R/MACHO



MEDIDA	ENV.	PRECIO
3/8"	12	1,31
1/2"	12	1,63
3/4"	12	2,66
1"	12	4,00
1 1/4"	6	7,65
1 1/2"	6	10,75
2"	3	17,55

RACOR BARCELONA MANGUERA-MANGUERA



MEDIDA	ENV.	PRECIO
20 x 20	12	6,44
25 x 25	12	9,51
30 x 30	12	10,97
35 x 35	6	28,35

RACOR BARCELONA MANGUERA - R/MACHO



MEDIDA	ENV.	PRECIO
20 x 1/2"	12	6,07
25 x 3/4"	12	8,72
30 x 1"	12	11,26
35 x 1 1/4"	6	23,58
45 x 1 1/2"	6	29,89

RACOR DEPOSITO



MEDIDA	ENV.	PRECIO
3/8"	10	1,97
1/2"	10	2,68
3/4"	10	3,80
1"	10	4,85
1 1/4"	10	7,43
1 1/2"	5	11,74
2"	5	22,70

ENLACE MANGUERA ROSCA MACHO



MEDIDA	ENV.	PRECIO
1"	12	7,40
1 1/4"	12	12,38

GRIFO FLOTADOR GUIAS VARILLA PLANA ARTICULADO



MEDIDA	ENV.	PRECIO
1/2"	12	9,37
3/4"	12	14,17
1"	6	20,76

Boyas de Plástico y Latón para Grifo Flotador Guias



MEDIDA	ENV.	PRECIO
1/2" - 11cm	12	3,30
3/4" - 13cm	12	4,27
1" - 15cm	6	5,48
1 1/4" - 20cm	2	5,81
3/8" - 9 cm	12	24,37
1/2" - 11cm	12	25,40
3/4" - 13cm	12	29,21
1" - 15cm	6	36,56
1 1/4" - 20cm	2	63,98

ACCESORIOS CISTERNAS Y DEPOSITOS

Regulador de nivel QUICKSTOP

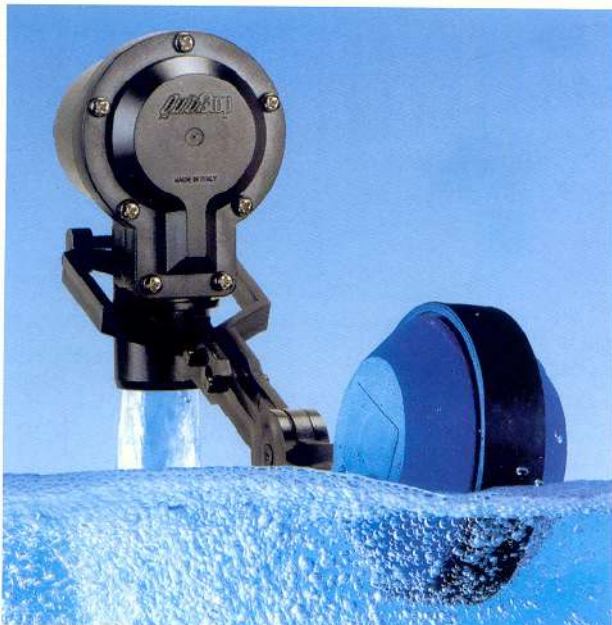

QUICKSTOP

Regulador de nivel de cierre instantáneo con filtro incorporado, para el llenado de depósitos cisternas.

- Elimina los defectos clásicos que los modelos tradicionales suelen plantear, como son: problemas de cal, desgaste del cierre causado por aguas duras, deszincificación, etc.
- Rápido en la intervención posición abierta/cerrada.
- Totalmente silencioso, evita rumorosidad.
- Totalmente estanco. Su sistema de membrana facilita un cierre total.
- Impide la adherencia calcárea.
- Anticorrosivo.
- Higiénico.

Temperatura de funcionamiento: 0 +50 °C.
Temperatura de almacenamiento: -20 +80 °C.
Servicio: continuo.
Presión de trabajo: 0,2-6 bar.
Sobrepresión máx.: 6 bar.

NOTA: A pesar de que el QuickStop incorpora filtro de serie, en instalaciones donde se detecte la presencia de arenilla o cualquier otro tipo de partícula, recomendamos la instalación de un filtro de asiento inclinado antes del QuickStop. De una parte dotamos al mismo de una doble seguridad y de otra protegemos al resto de la instalación: griferías, bombas, etc.



**Con filtro
incorporado**

QUICKSTOP

Regulador de nivel,
para llenado de cisternas.

MEDIDA	ENV.	PRECIO/UD
3/8"	6	20,60
1/2"	6	20,94
3/4"	6	28,19
1"	3	29,39
1 1/4"	2	36,48
1 1/2"	2	43,41

GRIFO FLOTADOR GUIAS VARILLA PLANA



MEDIDA	ENV.	PRECIO/UD
1/2"	6	14,28
3/4"	6	17,04
1"	3	20,84
1 1/4"	2	44,48
1 1/2"	2	58,45
2"	1	90,12

BOYA COBRE PLANA



MEDIDA	ENV.	PRECIO/UD
12 cm x 1/2"	6	30,99
15 cm x 3/4"	6	37,96
17 cm x 1"	3	43,70
20 cm x 1 1/4"	2	72,20
23 cm x 1 1/2"	2	74,42
25 cm x 2"	1	80,56

VALVULA RETENCION MONOBLOQUE



Norma: EN 1717 / 2001
EN 13959 / 2004

Características técnicas:
- PN 30/15
- Válvulas MONOBLOQUE: Evita fugas
- Geometría HIDRODINAMICA: Mejor fluidez.
- Evita turbulencias
- Disco interno Vulcanizado recubierto de Silicona

CODIGO	MEDIDAS	ENVASE	PRECIO
018501201	1/2"	6	10,76 €
018501202	3/4"	6	13,92 €
018501203	1"	6	19,53 €
018501204	1¼"	6	28,25 €
018501205	1½"	6	32,07 €
018501206	2"	3	51,48 €
018501207	2½"	1	106,76 €

VALVULA RETENCION CLAPETA



CODIGO	MEDIDAS	ENVASE	PRECIO
392013380	1/2"	12	5,13 €
392013441	3/4"	12	12,35 €
392013410	1"	12	12,16 €
392013403	1¼"	6	16,91 €
392013397	1½"	4	21,53 €
392013434	2"	2	36,90 €

FILTRO DE LINEA (Malla inox 0,35 mm)



CODIGO	MEDIDAS	ENVASE	PRECIO
392009475	1/2"	6	4,18 €
392009512	3/4"	6	6,93 €
392009468	1"	6	9,36 €
392009499	1¼"	6	18,00 €

VALVULA RETENCION PIE

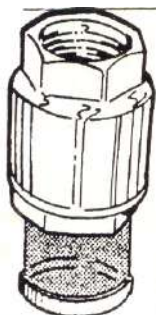

MEDIDAS	ENVASE	YORK	LATON
		PRECIO	PRECIO
3/4"	6	5,11 €	5,92 €
1"	6	9,51 €	10,40 €
1¼"	6	10,46 €	13,96 €
1½"	6	17,60 €	19,10 €
2"	3	29,33 €	26,29 €
2½"	3	34,76 €	
3"	3	54,46 €	

VALVULA RETENCION PIE KENT

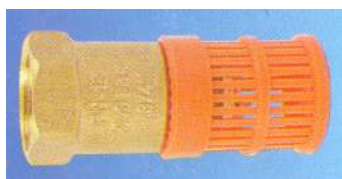

CODIGO	MEDIDAS	ENVASE	PRECIO
758200031	1"	12	8,75 €

VALVULA RETENCION PIE NYLON



Especial bombas de 1".
Cuerpo de Nylon
Muelle de acero inox

CODIGO	MEDIDAS	ENVASE	PRECIO
99991	1"	12	3,50 €

FILTRO INOX VALVULA PIE



CODIGO	MEDIDAS	ENVASE	PRECIO
0792002866	3/8"	8	1,74 €
792002880	1/2"	8	1,77 €
792002903	3/4"	8	1,94 €
792002927	1"	8	2,39 €
792002941	1¼"	8	2,88 €

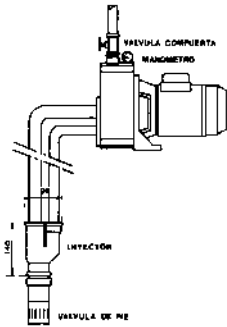

BOMBA AP



Modelo	Potencia	Alimentacion	PRECIO
AP-10 M	1 CV	Monofásica	195,00 €
AP-15 M	1,5 CV	Monofásica	321,76 €

Aplicaciones: Bomba centrífuga autoaspirante para aspiración profunda hasta 50 metros, por mediación de un inyector. Idónea para pozos de 4" o mayores.



JET 951M

BOMBA JET

Modelo	Potencia	Alimentacion	PRECIO
JET-102 M	1 CV	Monofásica	156,00 €
JET-15 M	1,5 CV	Monofásica	302,25 €

TURBINA EN BRONCE

Aplicaciones: Bomba autoaspirante con óptima capacidad de aspiración en presencia de gas en el agua. Particularmente indicada para el empleo de grupos de presión domésticos con aspiración negativa, pequeños riegos y jardines, etc. Para instalaciones superiores a 4 metros instalar tuberías de aspiración de mayor diámetro al indicado.
ASPIRACION MAXIMA 9 metros.

Serie **SUM / NAS** **ACERO INOX AISI 304**

BOMBAS SUMERGIBLES DE ACHIQUE

Aguas limpias (SUM) o sucias domésticas (NAS). Vaciado de locales inundados, piscinas, pozos, depósitos, etc

NOVEDAD



Modelo Model Modèle	Potencia P ₂		Tensión Voltage 1~ 50Hz	Condens. Capacitor (µF)	I (A)	Altura manométrica / Height / Hauteur (m)									Peso Weight Poids
	kW	HP				1	2	3	4	5	6	7	8	9	
SUM-100 W	0,75	1	230 V	16	3,0	16000	15500	15000	13500	11500	9800	7700	5400	2500	6,2 kg

PRECIO

120,91 €

Tipo	Motor P ₂		Paso sólidos	l/min m ³ /h	Caudal / Flow / Débit (l/h)												
	kW	HP			0	33	67	100	133	166	200	216	233				
NAS 550K	550	0,75	35 mm	m.c.a.	7	6	5	3,8	2	-	-	-	-	-	-		
NAS 900K	900	1,2	35 mm	m.c.a.	9	8,6	8	7,5	6,5	5	3	2	-	-			

PRECIO

136,50 €

162,83 €

Serie PV



Aplicaciones: Electrobombas sumergibles domesticas tipo Vortex para aguas ligeramente cargadas con cuerpos sólidos de diámetro max 30 mm. Ideales para su uso fijo o portátil como bomba de achique para fosas filtraciones de garajes, sótanos etc...Incorpora interruptor de nivel para arranque y para automático de la bomba.

Características Constructivas: Cuerpo Aspiración e impulsión y turbina en Tecnopolimero de alta resistencia, eje en acero inoxidable aisi 304 y cierre mecánico en cerámica-grafita.

Motor: Grado de protección IP-68 aislamiento clase B con motorprotector térmico incorporado.



Modelo Type	Voltaje Voltage	Wattios Watts	Caudal-Flow m ³ /h					Ø Sólidos Ø Solids	Ø Impulsión Ø Outlet
			0,5	3,5	5	9	13		
PV 750 H AUT	230 V Mono	750 W	8	6	4	2	0,5	35 mm.	25 - 32 mm.

PRECIO

117,42 €

No 47

BRIO 2000 c/manómetro



Características: Presión máxima 10 bar // Caudal máximo 9000 l/h // Corriente máxima 12A // Tensión 110/240V ± 10% // Conexión 1" // Temperatura máxima 55°C // Manómetro 0-12 bar // Presión de arranque 1 – 3,5 bar (regulado de fábrica 1,5 bar) // Después de detectar la falta de agua, ejecuta hasta 4 intentos, rearmando automáticamente después de detectar la presencia de agua. La regulación de la presión de arranque debe ser 0,5 bar superior en relación a la columna de agua de la instalación.

PRECIO
59,59 €

BRIO TOP digital electrónico



Características: Presión mínima (arranque) y presión máxima (parada) regulables // Caudal máximo 9000 l/h // Rearme automático. Permite definir el número de intentos de arranque después de la desconexión por falta de agua // Protección antibloqueo // Protección antiheladas // Protección contra sobrepresión // Contador de horas de funcionamiento // Tensión 240V // Corriente nominal 16A // Presión máxima 10 bar // Conexión 1" macho // Temperatura máxima del agua 30°C // Permite la utilización de 2 bombas en alternancia.

PRECIO
159,24 €

Serie SILVER

Modelo Model Modèle	Potencia P ₂		Cond. Capac. (µF)	I (A) 1~ 230V	Caudal / Flow / Débit (l/h)							Ø DNI DNM	Peso Weight Poids (kg)	Ø Bomba Pump Pompe (mm)	Altura Height Hateur (mm)
	kW	HP			1000	2000	3000	4000	5000	6000	7000				
					Altura manométrica / Height / Hateur (m)										
SILVER-100 M	0,75	1	30	5,4	40	38	36	31	25	17	10	1 ¼"	14,8	128	510
SILVER-150 M	1,1	1,5	35	7,5	60	56	54	47	37	26	15	1 ¼"	17,4	128	605



5"



Motor: 2850 rpm, refrigerado por agua bombeada.

Grado de protección: IP-68.

Clase de aislamiento: B.

Eje, camisa, cuerpo impulsión, rejilla de aspiración y tornillería:

Acero inoxidable 'AISI 304'.

Turbinas y difusores: Noryl.

Cierres mecánicos (doble):

Cerámica / Grafito.

Cable eléctrico: 15 m. 4x1mm².

Temperatura máx.: 35°C.

Inmersión máxima: 20 m.

Contenido arena: 40 g/m³ max.

pH admitido: 6,5 a 8,5.

Todos los modelos incluyen interruptor de nivel y CONTROLBOX con interruptor ON/OFF, condensador y disyuntor incorporados.

Potencia	PRECIO
1 CV	331,51 €
1,5 CV	370,50 €

Electrobombas sumergibles multicelulares ideales para su instalación en depósitos y pozos abiertos.

ACUMULADORES HIDRONEUMATICOS



REFERENCIA	MEDIDAS (cm)			VOLUMEN litros	PESO kg	PRECIO €
	A	B	C			
PEW24	44,4	29,2		24	5,6	65,87
AMF-S-PLUS	62,0	39,0	36,0	50 Horiz.	12,8	180,27
AMF-P-PLUS	41,4	52,8	21,3	50 Vertic.	12,8	168,13

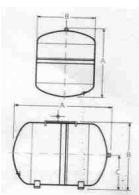

CARACTERISTICAS:

- Diseño con una sola membrana.
- Certificaciones: standard 61 de la NFS y CE/PED.
- Conexión de agua patentada.
- Revestimiento de polipropileno virgen.
- Acabado con pintura de poliuretano sobre base de epoxi.
- Tapón de la válvula de aire sellado mediante junta tórica antiescapes.
- Control de calidad en todas las fases de producción.
- No requieren mantenimiento.

HIDROFERAS ACERO INOX



HIDROFERA ACERO 25 litros



Cantidad	PRECIO
6	37,79 €
12	32,17 €

Modelo	Capacidad	Dimensiones Generales (mm)				Conex.	UN	PRECIO
		A	Ø B	C	D			
DH-25	25 litros	370	360			1"	1	144,26 €
DH-25	25 litros	370	360			1"	6	138,90 €
DH-25	25 litros	370	360			1"	12	133,57 €
DH-60	60 litros	625	390	360	235	1"	1	395,64 €
	24 litros		260			1"	1	84,17 €

REPUESTOS HIDROFERA

	Capacidad	Cantidad	PRECIO
Membrana	25 litros	6	10,73 €
Membrana	60 litros	1	41,71 €
Membrana c/oreja	60 litros	1	42,29 €
Membrana c/oreja	100 litros	1	46,83 €
Válvula		6	7,15 €

- Rosca: 1/4" Gas
- Contactos: 16 Amp.



PRESOSTATOS

Cantidad	Square	
	SK-2	FSG-2
6	8,20 €	16,00 €
18	7,88 €	15,39 €



RACOR 5 VIAS 120mm

UN	PRECIO
6	15,40 €
12	14,78 €



ENLACE R/MACHO FITTING para Venture

Medida	UN	PRECIO
1"	6	22,14 €

HIDROINYECTOR VENTURE completo (latón)

UN	PRECIO
2	63,16 €



TROMPETA

UN	PRECIO
6	9,71 €



CURVA MOTOR

CON ROSCA

Medida	UN	PRECIO
1"	12	33,34 €
1"	24	32,05 €
1 1/4"	12	54,87 €
1 1/4"	24	52,75 €

CON ESTRIAS

Medida	UN	PRECIO
1"	12	22,57 €

CON FITTING

Medida	UN	PRECIO
1"	12	32,18 €
1 1/4"	12	47,50 €

**D06F**

Válvula reductora de presión, con escala manométrica, para agua, aire comprimido y nitrógeno. Para agua hasta 40° C

Asiento equilibrado. Conexión para manómetro. Filtro de acero inoxidable y vaso transparente. Cuerpo y racores de latón, caja del muelle, cabeza de regulación y elementos internos de material sintético de alta calidad. Presión de entrada: 25 bar máx. Presión de salida: 1,5 - 6 bar.

REDUCTORA Honeywell D06F

CODIGO	MEDIDAS	ENVASE	PRECIO
0347006032	1/2"	1	147,30 €
0347006063	3/4"	1	153,13 €
0347006049	1"	1	201,42 €
0347006025	1 1/4"	1	306,98 €
0347006018	1 1/2"	1	531,45 €

REDUCTORA Honeywell D04FS

Valvula reductora de presión para agua hasta 70 °C

Conexiones roscadas internas/externas

Asiento equilibrado

Conexión con manómetro

Presión de salida ajustable de 1,5 a 6 bar

Cuerpo de latón

Tapa del muelle y partes internas

de material sintético de alta calidad.

Presión máxima 16 bar

Manómetro no incluido



CODIGO	MEDIDA	UN	PRECIO
0347026399	1/2"	6	43,56 €
0347026405	3/4"	6	54,72 €

REDUCTORA WATTS DRV

REFERENCIA	Ø	UN	PRECIO / UN
0501115	1/2"	3	65,18 €
0501120	3/4"	3	89,80 €
0501125	1"	3	109,43 €

Reductora MT

Cuerpo: Latón
 Asiento: Acero Inoxidable
 Obturador: Goma
 Presión Max. Entrada: 15 bar
 Presión Salida: Regulable 0,5 - 4 bar
 Temperatura Máxima: 70 °C
 Conexión; Roscas H-H

CODIGO	MEDIDA	UN	PRECIO	
			NORMAL	RACOR
415015	1/2"	6	27,71 €	
415020	3/4"	6	39,80 €	
4151025	1"	6	46,76 €	79,17 €
4151032	1 1/4"	6	91,49 €	151,47 €
4151040	1 1/2"	2	94,40 €	163,54 €
4151050	2"	2	150,36 €	268,51 €
4151065	2 1/2"	2	215,73 €	
	3"	2	310,44 €	

**REDUCTORA JUNIOR**

Presión máxima de entrada 16 bar.
 Presión de salida regulable de 1 a 5,5 bar.
 Se suministra tarado a 3 bar.
 Con toma portamanómetro 1/4" y purga situada bajo el aparato.
 Caudal 3.000 litros hora.

CODIGO	MEDIDA	UN	PRECIO
0382037036	1/2"	6	38,75 €
0382037043	3/4"	6	43,95 €
	1"	2	90,60 €

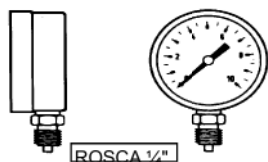
MANOMETRO RADIAL

ROSCA 1/2"

CODIGO	MEDIDAS	ENVASE	PRECIO
850010	0 -10 Kg cm2	12	4,29 €
850016	0 -16 Kg cm2	12	3,80 €

MANOMETRO GLICERINA

CODIGO	MEDIDAS	ENVASE	PRECIO
859910	10 bar	6	10,54 €
859916	16 bar	6	10,54 €
859925	25 bar	6	8,64 €

VALVULA RETENCION MINI VAYCA

CODIGO	MEDIDA	ENVASE	PRECIO
R/V-11	1/2"	12	5,08 €
R/V-12	3/4"	12	6,10 €
R/V-13	1"	12	7,25 €

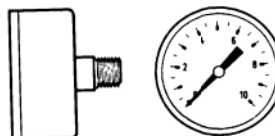
MANOMETRO POSTERIOR

ROSCA 1/2"

CODIGO	MEDIDAS	ENVASE	PRECIO
840010	0 -10 Kg cm2	12	4,55 €
840016	0 -16 Kg cm2	12	3,80 €

VALVULA ANTIRRETORNO PARA BATERIAS DE BAÑO Y DUCHA

CODIGO	MEDIDAS	PRECIO
056002	1/2" M - H	2,99 €

Baterías de contador INOX

VALVULAS ESCUADRA ANTI-RETORNO



Modelo RPE
Válvula de entrada
con brida orientable

Medida	Precio
3/4"	16,63 €
1"	19,01 €

Fabricadas en latón
Volantes de resina



Modelo RPS
Válvula de salida

Medida	Precio
3/4"	18,63 €
1"	18,64 €



Ref. BH002



Características:

1. Pletina con cuello de acero inoxidable AISI 304L.
2. Gancho de sujeción de acero F-111 de Ø 10 mm.
3. Placa de identificación adhesiva.
4. Circuito de batería de acero inoxidable AISI 316L.
5. Brida de aluminio.
6. Contrabrida de acero F-111 según norma DIN 2573.
 - Junta de EPDM.
 - Tornillería según DIN 931 y DIN 934.

Medida	Euros
4-2-2"	230,00
6-2-2"	276,36
6-3-2"	340,17
8-2-2½"	317,82
9-3-2½"	396,46
10-2-2½"	342,84
12-2-2½"	366,98
12-3-2½"	420,14
14-2-2½"	392,65
15-3-2½"	459,64
16-2-2½"	427,12
18-2-2½"	463,89
18-3-2½"	500,03
20-2-2½"	488,27
21-3-2½"	541,22
22-2-2½"	519,31
24-2-2½"	565,32
24-3-2½"	583,70
26-2-2½"	593,37
27-3-2½"	641,85
28-2-2½"	618,80
30-2-2½"	648,26
30-3-2½"	669,88
33-3-3"	906,89
36-3-3"	979,00
39-3-3"	1038,84
42-3-3"	1088,51
45-3-3"	1147,20

Ref. BH003

Medida	Euros
4-2-2"	148,23
6-2-2"	166,95
6-3-2"	204,53
8-2-2½"	204,79
9-3-2½"	266,19
10-2-2½"	217,23
12-2-2½"	234,28
12-3-2½"	285,62
14-2-2½"	248,36
15-3-2½"	303,81
16-2-2½"	265,67
18-2-2½"	288,23
18-3-2½"	331,22
20-2-2½"	307,32
21-3-2½"	361,64
22-2-2½"	327,76
24-2-2½"	345,00
24-3-2½"	391,39
26-2-2½"	367,42
27-3-2½"	422,26
28-2-2½"	385,09
30-2-2½"	406,20
30-3-2½"	450,04
33-3-3"	601,22
36-3-3"	624,73
39-3-3"	648,22
42-3-3"	671,73
45-3-3"	695,23

Baterías de contador PPR

Ref. BH003



Características:

1. Pletina orientable.
2. Circuito de tubo de polipropileno según UNE-EN ISO 15874-1:2004 y UNE-EN ISO 15874-2:2004.
3. Etiqueta identificativa.
4. Brida de acero F-111 según norma DIN 2573.
5. Contrabrida de acero F-111 según norma DIN 573.
 - Junta de EPDM.
 - Tornillería según EN-10204-1.1.

Cajas de Contadores



**CAJA CONTADOR
MONOFÁSICO
CON VISOR**

PRECIO
19,18 €

**CAJA CUADRO
DE SONDAS**



PRECIO
18,78 €

PUERTA CONTADOR DE AGUA

INOX

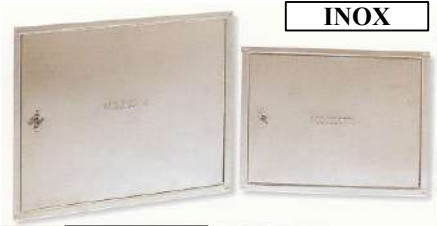

PVC

MEDIDA (cm)	PRECIO
30 x 40	55,17 €
30 x 45	31,92 €

GENERALIDADES SISTEMA HALYESTER

Aislamiento Total o Doble Aislamiento
Resistencia a la llama, autoextinguible
Alta resistencia a impactos
No higroscopico
Resistente a fugas superficiales
Insensible a variaciones bruscas de temperatura
Resistente a las atmósferas corrosivas
Ligero de peso
Facilidad de mecanización



ARMARIO DE POLIÉSTER

Reforzado con fibra de vidrio

Concebido para el alojamiento de contadores de agua. Cierra de pestillo accionado por tornillo allen.



Medidas Exterior	Medidas Caja	Cantidad	PRECIO UNIDAD
31 x 49	27 x 45	5	25,86 €
31 x 49	27 x 45	12	23,26 €
31 x 49	27 x 45	50	20,92 €



RACOR PRE-INSTALACIÓN

Para la posterior instalación de contadores de agua.
Simple exágono
conexión DN20, 3/4" M-M

Código	Conexión	Longitud	PRECIO
057820	3/4"	110	4,23 €

Llaves para cajas de contador

Latón estampado (según DIN 17660 Y 17662)

Juntas NBR (ASTM D2000. SAE 200)

DN 20 PN 25

STANDARD



ANTIRRETORNO

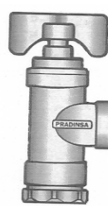

PURGA



MEDIDA	CANTIDAD	PRECIO	MEDIDA	CANTIDAD	PRECIO	MEDIDA	CANTIDAD	PRECIO
25 x 3/4H	6	28,83 €	25 x 3/4H	6	33,30 €	25 x 3/4H	6	34,08 €
32 x 3/4H	4	31,97 €	32 x 3/4H	4	34,95 €	32 x 3/4H	4	37,38 €

Contadores de agua y llaves de batería



- Contadores de paso libre
- Lectura directa 5 números
- Adaptados para aguas turbias y fuertemente calcáreas
- Relojería orientable manualmente
- Tapa de vidrio no manipulable
- Conforme a las normas CEE
- Temp. De ejercicio: agua fría máx. 30°C - agua caliente máx. 90°C
- Presión de ejercicio: máx. 16 bar (prueba 25 bar)
- Conexiones a racor

Medida (DN)	Precio
13 (1/2")	39,33 €
13 (1/2") Sr. C	58,80 €
15 (1/2")	39,03 €
20 (1")	58,65 €
25 (1 1/4")	114,67 €

	13	15	20	25
Longitud	110 mm	110 mm	130 mm	260 mm
Altura	66 mm	66 mm	70 mm	120 mm
Altura de Montaje	138 mm	138 mm	143 mm	200 mm
Diámetro	72 mm	72 mm	72 mm	100 mm
Roscas contador	7/8" 3/4" M	3/4" M	1" M	1 1/4" M
Racores	1/2" M	1/2" M	3/4" M	1" M
Caudal nominal	1,5 m ³ /h	1,5 m ³ /h	2,5 m ³ /h	3,5 m ³ /h
Caudal máximo	3 m ³ /h	3 m ³ /h	5 m ³ /h	7 m ³ /h
Caudal mínimo horizontal	30 l/h	30 l/h	50 l/h	70 l/h
Caudal mínimo vertical	60 l/h	60 l/h	100 l/h	100 l/h
Caudal transición horizontal	120 l/h	120 l/h	250 l/h	280 l/h
Caudal transición vertical	150 l/h	150 l/h	200 l/h	

OFERTA
Caja de 12 Uds.
Descuento 5%

NOTA
EL PRECIO INCLUYE RACORES,
HOMOLOGACION Y
VERIFICACION

RACORES



CODIGO	DN	ROSCA	Precio
135	13	3/4"	2,66 €
136	15	7/8"	3,19 €
137	20	1"	4,78 €
138	25	1 1/4"	9,56 €
139	30	1 1/2"	13,72 €
140	40	2"	15,93 €
196	40	2 1/2"	33,98 €

Atención:
Precio por unidad
2 unidades por contador

VALVULAS ESFERA CONTADOR DE AGUA



VALVULA RECTA ROSCA

VALVULA ANGULAR ROSCA



VALVULA RECTA ROSCA



VALVULA ANGULAR ROSCA

NORMAL
Entrada

5221	
Medida	Precio
3/4"	15,91 €
1"	22,30 €

5321	
Medida	Precio
3/4"	33,33 €
1"	22,31 €

M-505 M	
Medida	Precio
7/8" - 3/4"	17,89 €

M-525 M	
Medida	Precio
7/8" - 3/4"	37,99 €
3/4" - 3/4"	36,19 €

ANTI RETORNO
Salida

5226	
Medida	Precio
3/4"	19,20 €
1"	21,83 €

5326	
Medida	Precio
3/4"	35,23 €
1"	24,05 €

M-555 M	
Medida	Precio
7/8" - 3/4"	24,36 €

M-515 M	
Medida	Precio
7/8" - 3/4"	40,54 €
3/4" - 3/4"	38,74 €

Valvula Recta FITTING - Tuerca Loca

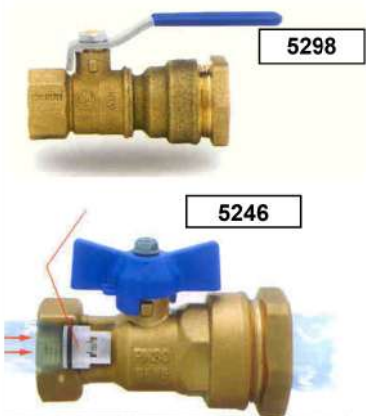

5298

5246

NORMAL
ENTRADA

Medida	Precio
25 x 3/4"	15,96 €
32 x 1"	27,25 €

ANTI - RETORNO
SALIDA

Medida	Precio
25 x 3/4"	19,16 €
32 x 1"	31,47 €

Valvula Angular FITTING - Tuerca Loca



NORMAL
ENTRADA

Medida	Precio
25 x 3/4"	47,55 €
25 x 7/8"	48,30 €
32 x 1"	50,76 €

ANTI - RETORNO
SALIDA

Medida	Precio
25 x 3/4"	48,97 €
25 x 7/8"	50,60 €
32 x 1"	52,77 €



VASO DE 9" 3 PIEZAS

Medida	Envase	Precio
3/4"	1	31,86 €
1"	1	31,86 €

Precio sin cartucho



CARTUCHO DE 9"

Tipo	Envase	Precio
Polipropileno	1	4,77 €
Inox	1	32,80 €
Nylon	1	14,00 €



VASO DE 5" 2 PIEZAS

Medida	Envase	Precio
3/4"	1	27,36 €

Precio sin cartucho



CARTUCHO DE 5"

Tipo	Envase	Precio
Polipropileno	1	4,11 €
Inox	1	28,33 €
Nylon	1	11,39 €

Caudal Nominal : 3500 l/h (nylon 1800 l/h)

Filtracion	Polipropileno	Inox	Nylon
	10 micras	50 micras	60 micras



LLAVE FILTRO 3 PIEZAS

Ø	Envase	Precio
5"	1	5,80 €
9"	1	5,80 €



FLOW CLARIFICADOR

Elimina arena, algas, herrumbe microorganismos, etc.

El filtraje se realiza mediante cartucho de arena de cuarzo. Lavable

Grado de filtración standard: 30 micras (sobre pedido 200-300 micras)

Presión de trabajo: 25 atm.

Caudal: 2000 l/h

Medida	Envase	Precio
1"	1	93,15 €

Precio con cartucho y llave

CARTUCHO

Tipo	Envase	Precio
Cuarzo	1	26,27 €

Filtros de Agua



Filtro HONEYWELL Miniplus

Referencia	Medida	Envase	Precio
FF06-1/2AA	1/2"	1	86,27 €
FF06-3/4AA	3/4"	1	95,63 €
FF06-1AA	1"	1	124,00 €
FF06-1AA	1 1/4"	1	128,06 €

Vaso de decantación transparente.
Cartucho inoxidable
Rosca interior y exterior
Malla 100 µm
Temperatura máxima 40 °C
Presión máxima 16 bar

Código	Medida	Envase	Precio
FF06-1/2EA	1/2"	1	90,52 €
FF06-3/4EA	3/4"	1	98,87 €
FF06-1EA	1"	1	118,54 €



Filtro HONEYWELL F 74 CS

Filtro autolimpiante a contracorriente

Sistema de lavado a contracorriente con turbina interior,
Temperatura máxima del agua: 30 °C
Cabezal con tomas orientables (permite la instalación del filtro en
redes de agua verticales y horizontales).
Cuerpo en material sintético. Vaso transparente.
Capacidad de filtrado: 90 / 100 micras
Red filtrante en acero inox.
Presión de trabajo: mínima 1,5 bar // máxima 16 bar.
Posibilidad de automatización de limpieza.

CON REDUCTORA

Referencia	Medida	Envase	Precio	Precio
F74C-3/4AA	3/4"	1	300,60 €	387,16 €
F74C-1AA	1"	1	314,64 €	425,76 €
F74C-1 1/4AA	1 1/4"	1	329,85 €	458,51 €



Filtro MT

Filtro autolimpiante // sin manómetro

Cartucho de acero inox.
Filtración: 100 micras
Caudal 3/4": 2300 l/h
Caudal 1": 4300 l/h

Código	Medida	Envase	Precio
4160020	3/4"	1	93,39 €
4160025	1"	1	113,17 €
4160032	1 1/4"	1	117,09 €

ABRAZADERAS REPARACION

Características técnicas

Fabricadas completamente en acero inoxidable.
con pasivado total.

Tornillos protegidos con aplicación PTFE.

Junta interior NBR (según DIN 3535/3).

Amplia gama de tamaños.

Utilizable en conducciones de agua, gas,
aceites, etc.

De peso liviano y sin piezas sueltas.

Tirador para facilitar el montaje.

Etiqueta de identificación adherida a cada unidad.



CODIGO	MEDIDA	UN	PRECIO
ARV00025	1/2"	6	38,93 €
ARV00030	3/4"	6	39,66 €
ARV00037	1"	4	38,93 €
ARV00045	1¼"	2	43,16 €
ARV00051	1½"	2	45,95 €
ARV00064	2"	1	83,04 €

ABRAZADERA-TAPAPOROS PARA TUBO DE COBRE



CODIGO	MEDIDA	PRECIO
325001864	10 mm	7,33 €
325001871	12 mm	7,94 €
325001888	14 mm	12,88 €
325001895	15 mm	11,49 €
325005985	16 mm	11,73 €
325001901	18 mm	11,88 €
325001918	22 mm	14,81 €
325001925	28 mm	19,06 €
325001932	35 mm	31,16 €
0325001949	42 mm	42,28 €
0325001956	54 mm	51,22 €

CODIGO	MEDIDA	ROSCA	PRECIO
325001796	15 mm	1/2"	15,96 €
325001902	18 mm	1/2"	16,51 €
325001819	22 mm	1/2"	17,43 €
	28 mm	3/4"	24,30 €
	35 mm	3/4"	35,33 €
	42 mm	1"	53,00 €
0325001857	54 mm	1¼"	83,01 €

5120

**MANGUITO ELASTICO
DOBLE ONDA PN-16**



ADAPTADOR VALVULA RADIADOR



MEDIDAS	UN	PRECIO/UD
12x1/2"	20	4,60 €
15x1/2"	20	4,60 €

CODE	DT	UN	PRECIO/UD
5120-020	3/4"	1	14,40 €
5120-025	1"	1	18,72 €
5120-032	1¼"	1	21,82 €
5120-040	1½"	1	27,30 €
5120-050	2"	1	34,13 €

Nº 57

RACORES PARA TUBO DE ACERO

(DIN 2440 - 2441 - 2442 - 2448 - 2458)



Tipo A
Rosca macho

- PN 16 Agua
- PN 4 Gas
- Temperatura: Agua +80°C
Gas -20°C / +70°C

Ø Ext.	mm	Nº Artículo	PRECIO
3/8"	17,2	01.150.00.00	14,33 €
1/2"	21,3	01.150.00.01	14,33 €
3/4"	26,9	01.150.00.02	16,06 €
1"	33,7	01.150.00.03	18,12 €
1 1/4"	42,4	01.150.00.04	25,38 €
1 1/2"	48,3	01.150.00.05	30,81 €
2"	60,03	01.150.00.06	43,24 €



Tipo I
Rosca hembra

- PN 16 Agua
- PN 4 Gas
- Temperatura: Agua +80°C
Gas -20°C / +70°C

Ø Ext.	mm	Nº Artículo	PRECIO
3/8"	17,2	01.150.01.00	14,50 €
1/2"	21,3	01.150.01.01	14,50 €
3/4"	26,9	01.150.01.02	16,32 €
1"	33,7	01.150.01.03	18,21 €
1 1/4"	42,4	01.150.01.04	25,90 €
1 1/2"	48,3	01.150.01.05	30,98 €
2"	60,03	01.150.01.06	45,49 €



Tipo 0
Manguito

- PN 16 Agua
- PN 4 Gas
- Temperatura: Agua +80°C
Gas -20°C / +70°C

Ø Ext.	mm	Nº Artículo	PRECIO
3/8"	17,2	01.150.02.00	18,73 €
1/2"	21,3	01.150.02.01	18,73 €
3/4"	26,9	01.150.02.02	23,56 €
1"	33,7	01.150.02.03	27,11 €
1 1/4"	42,4	01.150.02.04	34,01 €
1 1/2"	48,3	01.150.02.05	44,80 €
2"	60,03	01.150.02.06	68,26 €

ENLACES DE TRANSICION PARA TUBO DE ACERO

SERIE 98 PN-30

MANGUITO



Nº Artículo	DT	UN	PRECIO
98010021	21	10	11,84 €
98010027	27	6	13,15 €
98010034	34	6	18,37 €
98010043	43	6	27,30 €
98010049	49	2	45,78 €
98010061	61	2	82,37 €

ENLACE ROSCA MACHO



Nº Artículo	DT	UN	PRECIO
9809002115	21 x 1/2"	10	7,70 €
9809002720	27 x 3/4"	6	9,10 €
9809003425	34 x 1"	6	12,27 €
9809004332	43 x 1 1/4"	6	15,95 €
9809004940	49 x 1 1/2"	2	26,69 €
9809006150	61 x 2"	2	45,24 €

ENLACE ROSCA HEMBRA



Nº Artículo	DT	UN	PRECIO
9811002115	21 x 1/2"	10	6,83 €
9811002720	27 x 3/4"	6	8,75 €
9811003425	34 x 1"	6	13,33 €
9811004332	43 x 1 1/4"	6	16,74 €
9811004940	49 x 1 1/2"	2	25,80 €
9811006150	61 x 2"	2	49,14 €

RACORES PARA TUBO DE ACERO

(DIN 2440 - 2441 - 2442 - 2448 - 2458)



Tipo T
Té rosca hembra

- PN 16 Agua
- PN 4 Gas
- Temperatura: Agua +80°C
- Gas -20°C / +70°C

Ø Ext.	mm	Nº Artículo	PRECIO
3/8"	17,2	01.150.04.00	20,71 €
1/2"	21,3	01.150.04.01	20,71 €
3/4"	26,9	01.150.04.02	24,51 €
1"	33,7	01.150.04.03	29,17 €
1¼"	42,4	01.150.04.04	39,01 €
1½"	48,3	01.150.04.05	46,77 €
2"	60,03	01.150.04.06	72,41 €

ABRAZADERAS-TAPAPOROS PARA TUBO DE ACERO

(DIN 2440 - 2441 - 2442 - 2448 - 2458)



Tipo DT
Abrazadera con toma

- PN 16 Agua
- Temperatura: hasta +80°C
- Fluidos: Agua

Ø		mm	Nº Artículo	PRECIO
Ext.	Toma			
1/2"	1/2"	17,2	01.260.28.0101	10,32 €
3/4"	1/2"	21,3	01.261.28.0201	12,04 €
1"	1/2"	26,9	01.261.28.0301	15,13 €
1"	3/4"	33,7	01.261.28.0302	15,13 €
1¼"	3/4"	42,4	01.261.28.0402	17,65 €
1½"	3/4"	48,3	01.261.28.0502	22,00 €
2"	1"	60,03	01.261.28.0603	29,07 €



Tipo DC
Tapaporos corto

- PN 16 Agua
- Temperatura: hasta +80°C
- Fluidos: Agua

Ø Ext.	Rosca	Nº Artículo	PRECIO
1/2"	21,3	01.260.28.01	16,43 €
3/4"	26,9	01.260.28.02	18,56 €
1"	33,7	01.260.28.03	27,23 €
1¼"	42,4	01.260.28.04	32,46 €
1½"	48,3	01.260.28.05	33,77 €
2"	60,03	01.260.28.06	43,60 €

Para la medida de 3/8", utilizar el tipo RD 16/18

ACCESORIOS DE LATON PARA TUBO DE POLIETILENO



**RACOR CODO PLACA
ROSCA HEMBRA A TUBO**

MEDIDA	ENVASE	PRECIO
20 x 1/2"	10	5,82 €
25 x 3/4"	10	8,31 €
32 x 1"	5	12,10 €



**RACOR RECTO ROSCA
HEMBRA A TUBO**

MEDIDA	ENVASE	PRECIO
20 x 1/2"	10	3,08 €
25 x 3/4"	10	4,61 €
32 x 1"	5	8,20 €
40 x 1 1/4"	2	10,23 €
50 x 1 1/2"	2	16,78 €
63 x 2"	2	26,29 €



**RACOR RECTO ROSCA
MACHO A TUBO**

MEDIDA	ENVASE	PRECIO
20 x 1/2"	10	2,92 €
25 x 3/4"	10	5,08 €
32 x 1"	5	7,56 €
40 x 1 1/4"	2	13,13 €
50 x 1 1/2"	2	15,45 €
63 x 2"	2	25,22 €



**RACOR UNION RECTO
ACOPLAMIENTO A TUBO**

MEDIDA	ENVASE	PRECIO
20 x 20	10	4,69 €
25 x 25	10	9,35 €
32 x 32	5	12,48 €
40 x 40	2	20,43 €
50 x 50	3	24,85 €
63 x 63	2	41,87 €



**RACOR CODO ROSCA
HEMBRA A TUBO**

MEDIDA	ENVASE	PRECIO
20 x 1/2"	10	4,24 €
25 x 3/4"	10	6,17 €
32 x 1"	5	12,41 €
40 x 1 1/4"	2	14,36 €
50 x 1 1/2"	2	26,46 €
63 x 2"	2	37,68 €

Nº 60

****** OFERTA ******
ENVASE COMPLETO 5% DTO.

ACCESORIOS DE LATON PARA TUBO DE POLIETILENO



**RACOR CODO ROSCA
MACHO A TUBO**

MEDIDA	ENVASE	PRECIO
20 x 1/2"	10	4,56 €
25 x 3/4"	10	7,33 €
32 x 1"	5	11,00 €
40 x 1 1/4"	2	19,08 €
50 x 1 1/2"	2	23,95 €
63 x 2"	2	39,09 €



**RACOR CODO
ACOPLAMIENTO A TUBO**

MEDIDA	ENVASE	PRECIO
20 x 20	10	5,38 €
25 x 25	10	10,21 €
32 x 32	5	15,88 €
40 x 40	2	19,55 €
50 x 50	2	31,89 €
63 x 63	2	51,02 €



**RACOR TE ROSCA
HEMBRA A TUBO**

MEDIDA	ENVASE	PRECIO
20 x 1/2"	10	6,10 €
25 x 3/4"	10	9,33 €
32 x 1"	5	14,86 €
40 x 1 1/4"	2	22,88 €
50 x 1 1/2"	2	35,68 €
63 x 2"	2	58,55 €



**RACOR TE
ACOPLAMIENTO A TUBO**

MEDIDA	ENVASE	PRECIO
20 x 20	10	7,41 €
25 x 25	10	11,10 €
32 x 32	5	17,69 €
40 x 40	2	27,23 €
50 x 50	2	44,60 €
63 x 63	2	69,70 €



**RACOR TE ROSCA
MACHO A TUBO**

MEDIDA	ENVASE	PRECIO
20 x 1/2"	10	6,41 €
25 x 3/4"	10	9,76 €
32 x 1"	5	16,06 €
40 x 1 1/4"	2	23,57 €
50 x 1 1/2"	2	37,15 €
63 x 2"	2	62,72 €



ACCESORIOS DE LATON PARA TUBO DE POLIETILENO CON BRIDAS

89022

RACOR RECTO



REFERENCIA	Ø	PRECIO
89022-075	75	93,35 €
89022-090	90	131,91 €
89022-110	110	241,38 €

89122

RACOR RECTO HEMBRA



REFERENCIA	Ø	PRECIO
89122-075065	75 x 2½"	55,97 €
89122-090080	90 x 3"	83,90 €
89122-110100	110 x 4"	137,60 €

89042

RACOR CODO



REFERENCIA	Ø	PRECIO
89042-075	75	123,11 €
89042-090	90	176,90 €
89042-110	110	295,69 €

89142

RACOR CODO MACHO



REFERENCIA	Ø	PRECIO
89142-075065	75 x 2½"	83,40 €
89142-090080	90 x 3"	136,40 €

89062

RACOR TE



REFERENCIA	Ø	PRECIO
89062-075	75	173,38 €
89062-090	90	256,31 €
89062-110	110	423,12 €

89162

RACOR CODO HEMBRA



REFERENCIA	Ø	PRECIO
89162-075065	75 x 2½"	90,22 €
89162-090080	90 x 3"	132,28 €
89162-110100	110 x 4"	219,60 €

89102

RACOR RECTO MACHO



REFERENCIA	Ø	PRECIO
89102-075	75	53,82 €
89102-090	90	84,33 €
89102-110	110	141,33 €

89202

RACOR TE HEMBRA



REFERENCIA	Ø	PRECIO
89202-075065	75 x 2½"	144,53 €
89202-090080	90 x 3"	218,08 €
89202-110100	110 x 4"	350,75 €











FIGURA	CODIGO	MEDIDA			U/C	PVP
	20020	Ø 20		1/2"	80	1,60
	20025	Ø 25		3/4"	50	1,88
	20032	Ø 32		1"	90	2,88
	20040	Ø 40		1 ¼"	50	4,32
	20050	Ø 50		1 ½"	35	6,98
	20063	Ø 63		2"	18	10,94
	20075	Ø 75		2 ½"	9	18,60
	20090	Ø 90		3"	6	31,30
ENLACE ROSCA MACHO						
	20120	Ø 20		1/2"	80	2,00
	20125	Ø 25		3/4"	50	2,37
	20132	Ø 32		1"	90	3,12
	20140	Ø 40		1 ¼"	50	4,73
	20150	Ø 50		1 ½"	35	7,39
	20163	Ø 63		2"	18	11,40
ENLACE ROSCA HEMBRA						
	20520	Ø 20	Ø 20		50	2,59
	20525	Ø 25	Ø 25		90	3,16
	50532	Ø 32	Ø 32		55	4,80
	20540	Ø 40	Ø 40		30	8,34
	20550	Ø 50	Ø 50		20	11,64
	20563	Ø 63	Ø 63		8	17,93
	20575	Ø 75	Ø 75		6	32,83
	20590	Ø 90	Ø 90		4	54,67
ENLACE RECTO						
	20625	Ø 20	Ø 25		30	3,16
	20632	Ø 25	Ø 32		20	5,03
	20640	Ø 32	Ø 40		12	6,47
	20650	Ø 40	Ø 50		15	10,03
	20663	Ø 50	Ø 63		10	16,08
	20675	Ø 63	Ø 75		6	29,94
	20690	Ø 75	Ø 90		4	45,77
	ENLACE REDUCIDO					
	20420	Ø 20	Ø 20	Ø 20	75	3,96
	20425	Ø 25	Ø 25	Ø 25	50	4,80
	20432	Ø 32	Ø 32	Ø 32	30	6,87
	20440	Ø 40	Ø 40	Ø 40	18	10,55
	20450	Ø 50	Ø 50	Ø 50	12	17,21
	20463	Ø 63	Ø 63	Ø 63	4	27,13
	20475	Ø 75	Ø 75	Ø 75	3	46,65
	20490	Ø 90	Ø 90	Ø 90	2	69,14
TE 3 BOCAS						

FIGURA	CODIGO	MEDIDA			U/C	PVP
	20725	Ø 25	Ø 20	Ø 25	50	5,24
	20732	Ø 32	Ø 25	Ø 32	25	6,88
	20740	Ø 40	Ø 32	Ø 40	15	9,66
	20750	Ø 50	Ø 40	Ø 50	12	19,53
	20763	Ø 63	Ø 50	Ø 63	5	27,43

TE 3 BOCAS REDUCIDA

	22220	Ø 20	1/2"	Ø 20	40	3,40
	22225	Ø 25	3/4"	Ø 25	80	4,22
	22332	Ø 32	1"	Ø 32	40	5,89
	22440	Ø 40	1 1/4"	Ø 40	25	7,96
	22550	Ø 50	1 1/2"	Ø 50	15	15,71
	22663	Ø 63	2"	Ø 63	6	21,13

DERIVACION T ROSCA HEMBRA

	20320	Ø 20		Ø 20	45	2,73
	20325	Ø 25		Ø 25	25	3,39
	20332	Ø 32		Ø 32	45	4,90
	20340	Ø 40		Ø 40	25	7,55
	20350	Ø 50		Ø 50	5	12,26
	20363	Ø 63		Ø 63	6	19,14
	20375	Ø 75		Ø 75	4	32,69
	20390	Ø 90		Ø 90	3	54,40

CODO 90°

	20920	Ø 20	1/2"		70	2,35
	20925	Ø 25	3/4"		40	2,90
	20932	Ø 32	1"		20	4,38
	20940	Ø 40	1 1/4"		40	5,24
	20950	Ø 50	1 1/2"		7	8,97
	20963	Ø 63	2"		9	11,47

CODO 90° ROSCA MACHO

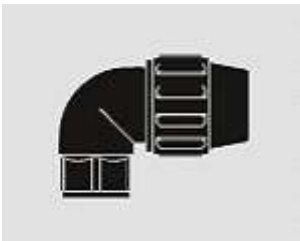
	20820	Ø 20	1/2"		70	2,94
	20825	Ø 25	3/4"		40	3,25
	20832	Ø 32	1"		20	4,38
	20840	Ø 40	1 1/4"		40	5,78
	20850	Ø 50	1 1/2"		7	9,86
	20863	Ø 63	2"		9	12,58
	20875	Ø 75	2 1/2"		6	25,56
	20890	Ø 90	3"		3	48,42

CODO 90° ROSCA HEMBRA



FIGURA	CODIGO	MEDIDA	U/C	PVP
	20220	Ø 20	100	2,04
	20225	Ø 25	60	2,43
	20232	Ø 32	30	3,71
	20240	Ø 40	15	4,56
	20250	Ø 50	12	7,24
	20263	Ø 63	18	11,16
	20275	Ø 75	12	29,51
	20290	Ø 90	8	37,11
TAPON FINAL				

	80000	Ø 20	1/2"	25	4,65
	80001	Ø 25	3/4"	25	5,65
PLACA GRIFO					

COLLARINES

	21501	Ø 25	1/2"	45	2,34
	21502	Ø 25	3/4"	45	2,34
	21503	Ø 32	1/2"	40	2,93
	21504	Ø 32	3/4"	30	2,93
	21505	Ø 32	1"	30	2,93
	21506	Ø 40	1/2"	25	3,51
	21507	Ø 40	3/4"	25	3,51
	21508	Ø 40	1"	25	3,51
	21509	Ø 50	1/2"	15	4,14
	21510	Ø 50	3/4"	15	4,14
	21511	Ø 50	1"	15	4,14
	21512	Ø 63	1/2"	15	6,03
	21513	Ø 63	3/4"	15	6,03
	21514	Ø 63	1"	15	6,03
	21516	Ø 63	1 1/2"	15	6,03
	21517	Ø 75	1/2"	10	7,48
	21518	Ø 75	3/4"	10	7,48
	21519	Ø 75	1"	15	7,48
	21521	Ø 75	1 1/2"	8	7,48
	21523	Ø 90	1/2"	6	9,23
21524	Ø 90	3/4"	6	9,23	
21525	Ø 90	1"	6	9,23	
21526	Ø 90	1 1/4"	6	9,23	
21527	Ø 90	1 1/2"	6	9,23	

ENLACE



CODIGO	MEDIDA	UN	PRECIO / UD
			€
070100020	20 x 20	100	3,61
070100025	25 x 25	90	4,40
070100032	32 x 32	50	6,26
070100040	40 x 40	50	9,84
070100050	50 x 50	30	13,71

ENLACE DE REPARACION



CODIGO	MEDIDA	UN	PRECIO / UD
			€
076100020	20 x 20	30	5,33
076100025	25 x 25	50	6,54
076100032	32 x 32	40	8,23
076100040	40 x 40	28	14,24
076100050	50 x 50	22	19,50
076100063	63 x 63	12	25,86
876100075	75 x 75	8	49,49
876100090	90 x 90	4	74,01
876100110	110 x 110	2	129,00



ENLACE REDUCIDO



CODIGO	MEDIDA	UN	PRECIO / UD
			€
071100025020	25 x 20	100	4,40
071100032025	32 x 25	90	5,88
071100040032	40 x 32	50	6,26
071100050040	50 x 40	50	13,71
071100063050	63 x 50	30	20,82

ENLACE MIXTO ROSCA MACHO



CODIGO	MEDIDA	UN	PRECIO / UD
			€
070200020005	20 x 1/2"	100	2,21
070200025007	25 x 3/4"	100	2,94
070200032010	32 x 1"	100	4,40
070200040013	40 x 1 1/4"	55	6,02
070200050015	50 x 1 1/2"	25	7,84
070200063020	63 x 2"	24	11,79
870200075025	75 x 2 1/2"	4	31,56
870200090030	90 x 3"	4	39,61
870200110040	110 x 4"	2	77,93



UNICO
EN EL
MUNDO



JUNTA PLANA PATENTADA

ENLACE MIXTO ROSCA HEMBRA



CODIGO	MEDIDA	UN	PRECIO / UD
			€
070300020005	20 x 1/2"	100	2,81
070300025007	25 x 3/4"	100	3,45
070300032010	32 x 1"	75	4,63
070300040013	40 x 1 1/4"	55	6,42
070300050015	50 x 1 1/2"	35	8,78
070300063020	63 x 2"	24	12,66
870300075025	75 x 2 1/2"	5	24,62
870300090030	90 x 3"	2	38,17
870300110040	110 x 4"	2	97,16



CODO 90º



CODIGO	MEDIDA	UN	PRECIO / UD
			€
070500020	20 x 20	50	3,61
070500025	25 x 25	50	4,41
070500032	32 x 32	50	6,27
070500040	40 x 40	30	9,77
070100050	50 x 50	10	13,71
070500063	63 x 63	12	20,73
870500075025	75 x 75	6	38,16
870500090030	90 x 90	4	63,56
870500110040	110 x 110	2	154,73



CODO 90º MIXTO ROSCA HEMBRA



CODIGO	MEDIDA	UN	PRECIO / UD
			€
071500020005	20 x 1/2"	50	4,70
071500025007	25 x 3/4"	50	5,49
071500032010	32 x 1"	25	6,94
071500040013	40 x 1 1/4"	20	8,59
071500050015	50 x 1 1/2"	20	13,24
071500063020	63 x 2"	20	15,25
871500075025	75 x 2 1/2"	9	33,46



CODO 90º MIXTO MURAL

CODIGO	MEDIDA	UN	PRECIO / UD
			€
077500020005	20 x 1/2"	50	5,99
077500025007	25 x 3/4"	50	6,50

SERIE 7

TE IGUAL



CODIGO	MEDIDA	UN	PRECIO / UD
			€
070400020	20 x 20	60	5,39
070400025	25 x 25	50	6,67
070400032	32 x 32	30	9,47
070400040	40 x 40	20	14,73
070400050	50 x 50	10	20,63
070400063	63 x 63	8	31,14
870400075	75 x 75	4	64,88
870400090	90 x 90	2	100,52
870400110	110 x 110	1	181,01



TE REDUCIDA



CODIGO	MEDIDA	UN	PRECIO / UD
			€
073400025020	25 x 20	50	6,67
073400032025	32 x 25	20	9,47
073400040032	40 x 32	20	14,73
073400050040	50 x 40	10	20,63
073400063040	63 x 40	10	31,18

TE MIXTA ROSCA HEMBRA



CODIGO	MEDIDA	UN	PRECIO / UD
			€
071400020005	20 x 1/2"	90	5,19
071400025007	25 x 3/4"	45	6,56
071400032010	32 x 1"	45	8,93
071400040013	40 x 1 1/4"	25	11,64
071400050015	50 x 1 1/2"	18	18,20
071400063020	63 x 2"	10	25,71

TAPON FINAL



CODIGO	MEDIDA	UN	PRECIO / UD
			€
071200020	20	50	2,94
071200025	25	50	3,27
071200032	32	30	5,16
071200040	40	25	6,34
071200050	50	10	9,32
071200063	63	10	12,95



JUNTA PLANA PATENTADA

ADAPTADOR ROSCA MACHO



CODIGO	MEDIDA	UN	PRECIO / UD
			€
072500025007	25 x 3/4"	20	4,42
072500032010	32 x 1"	30	5,18
072500040013	40 x 1 1/4"	20	7,20
072500050015	50 x 1 1/2"	20	8,77
072500063020	63 x 2"	15	13,24
072500075030	75 x 2 1/2"	10	21,28

PLASS4 - ENLACE UNIVERSAL



CODIGO	MEDIDA	UN	PRECIO / UD
			€
070170025022	25 x 15 - 22	10	22,29
070170025027	25 x 20 - 27	10	23,59
070170025035	25 x 27 - 35	10	27,83
070170032027	32 x 20 - 27	10	29,20
070170032035	32 x 27 - 35	10	29,20
070170050050	50 x 35 - 50	5	73,41

CASQUILLO APRIETE (tubos UPVC - PP)



CODIGO	MEDIDA	UN	PRECIO / UD
			€
07970020	20	50	2,95
07970025	25	50	3,22
07970032	32	50	3,50
07970040	40	20	4,09
07970050	50	20	8,20
07970063	63	20	11,07

TOMA EN CARGA (tubos PVC - PE)



CODIGO	MEDIDA	UN	PRECIO / UD
			€
165400063025	63 x 25	5	81,85
165400063032	63 x 32	5	79,71
165400075025	75 x 25	5	84,93
165400075032	75 x 32	5	84,93
165400090025	90 x 25	5	87,86
165400090032	90 x 32	5	87,86

HERRAMIENTA PARA BISELAR



CODIGO	MEDIDA	UN	PRECIO / UD
			€
189600063020P	20 - 63	5	87,87

DATOS TÉCNICOS

Materiales

Accesorios de Compresión

Cuerpo: Polipropileno, block copolímero de alta calidad.

Racor: Polipropileno, block copolímero de alta calidad.

Casquillo de apriete: Acetal (POM). Disponibles también en PVC-C.

Refuerzo interno de tubos: Acetal (POM).

Junta tórica: Nitrilo (NBR). Disponibles también en EPDM y FPM.

Anillo de refuerzo: Acero inoxidable en todas las tomas roscadas hembra de 1 1/4" a 4".

Tornillos (Series 17): Acero niquelado.

Tuercas: Acero inoxidable.

ALTA CALIDAD



Certificados de Calidad

Todos los accesorios de **PLASSON** se someten a pruebas de aprobación, de conformidad con las normativas ISO14236 y AS/NZ 4129.

Roscas

Todas las roscas responden a las normas ISO-7/1, BS 21, DIN 2999, EN 3258, AS 1722 Part 1 - 1975.



Todas las roscas hembra menores a 3" son paralelas. El resto de las roscas macho y hembra son cónicas.

Bridas

Las dimensiones de las bridas responden a las normas ISO 7005-1 (TABLE 11), BS 4504:1989 (TABLE 11), DIN 2501 (PN 16 TABLE), AS/NZS 4331.



Con todas las bridas debe ser utilizado como refuerzo una brida de metal.



Accesorios Roscados P.P.

J-82

Machón

REFERENCIA	MEDIDA	UN	Caja Nº	PRECIO
50410	1/2"	100	A-10	1,55 €
50404	3/4"	100	A-1	2,32 €
50405	1"	100	A-2	2,80 €
	1 1/4"	25		3,31 €
50400	1 1/2"	25		6,30 €
50409	2"	25		6,93 €

J-84

Machón Reducido

REFERENCIA	MEDIDA	UN	Caja Nº	PRECIO
50743	3/4" - 1/2"	100	A-1	1,25 €
50754	1" - 3/4"	100	A-2	1,72 €
50765	1" - 1 1/4"	100		2,01 €

J-88

Reducción hembra / macho

REFERENCIA	MEDIDA		UN	Caja Nº	PRECIO
	Macho	Hembra			
50601	1/2"	3/4"	100	A-1	1,25 €
50602	1/2"	1"	100	A-1	1,94 €
50654	3/4"	1"	100	A-1	2,08 €

J-89

Reducción macho / hembra

REFERENCIA	MEDIDA		UN	Caja Nº	PRECIO
	Macho	Hembra			
51543	3/4"	1/2"	100	A-10	1,43 €
51519	1"	1/2"	100	A-1	2,14 €
51554	1"	3/4"	100	A-1	2,14 €

JUNTA TORICA para accesorios de polietileno



CODIGO	Ø	UN	PRECIO
99990	20	50	0,31 €
99991	25	50	0,32 €
99992	32	50	0,65 €
99993	40	50	0,83 €
00938	50	25	1,08 €
99994	63	25	1,55 €
	75	25	2,16 €

No 66

Valvulas Jimten

ROSCAR

CODIGO	MEDIDA	UN	PRECIO
385708859	1/2"	12	9,43 €
385708806	3/4"	12	11,29 €
385708873	1"	12	16,96 €
385708880	1¼"	6	20,56 €
385708897	1½"	3	29,24 €
385708903	2"	2	39,87 €
385708910	2½"	1	194,99 €

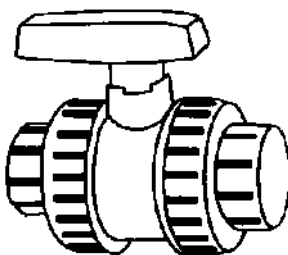

PEGAR

CODIGO	MEDIDA	UN	PRECIO
385708774	20	12	9,43 €
385708781	25	12	11,29 €
385708798	32	12	16,96 €
385708804	40	6	18,88 €
385708811	50	3	25,19 €
385708828	63	2	40,19 €
385708835	75	1	184,71 €
385708842	90	1	194,02 €



Fabricadas según las normas:

Encolar

ISO 727, UNI 7442/75, DIN 8063, NF T54-028, BS 4346/1, ISO 161/1
UNI 7441/75, DIN 8062, NF T54-016, BS 3506, BS 3505.

Roscar

UNI ISO 228/1, DIN 2999, BS 21.

Ø	DN	Roscado	PN
16	10	3/8"	16
20	15	1/2"	16
25	20	3/4"	16
32	25	1"	16
40	32	1¼"	16
50	40	1½"	16
63	50	2"	16
75	65	2½"	16
90	80	3"	16
110	110	4"	16

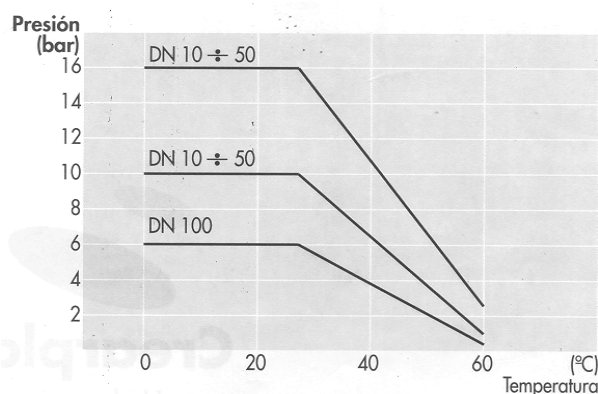

CON RACORES P.E.

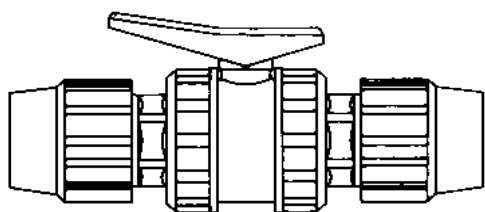

CODIGO	MEDIDA	UN	PRECIO
385718858	20	30	14,11 €
385718865	25	20	16,54 €
385718872	32	15	25,60 €
385718889	40	10	30,23 €
385718896	50	10	37,77 €
0385718902	63	10	49,80 €
0385718919	75	4	215,49 €
	90	3	231,50 €

**POR
CAJA**



DTO. 5%

Novedades

Nuevo accesorio pasamuros para aplicaciones de llenado y/o vaciado de depósitos, cisternas, etc.



PASAMUROS PARA DEPOSITOS

CODIGO	MEDIDA	UN	PRECIO
0750021741	25 x 3/4"	10	6,71 €
0750021758	32 x 1"	10	10,07 €



PRECIO
4,92 €



Disponible en 7 colores naturales: Blanco, Negro, Rojo, Azul, Verde, Amarillo, Violeta
3 colores fluorescentes: Naranja, Amarillo y Rosado

Comparación de Solid Marker de Sakura con un Marcador Convencional

	Sakura Solid Marker	Marcador convencional
¿Marca sobre cualquier superficie?	Si	No, sólo en superficies no absorbentes
¿Se ha de agitar antes de usar?	No	Si
¿La pintura/línea se resaca o gotea?	No	Si, a veces
Uso de todo el tubo de pintura/línea	Excelente	Regular
Manchado y mojado del papel	Excelente	Regular
Estabilidad escrita (papel, vidrio, metal, disposición pintura/línea)	Excelente	Mala
Marcaje desde cualquier posición	Excelente	Mala
Facilidad de escritura	Excelente	Regular

Resistencia Calorífica

Marca en las superficies calientes

Una hora después de marcar en una botella de aluminio con alcohol de limpieza

Las propiedades de marcaje/escritura son más débiles. (No se recomienda utilizar)

Las propiedades de marcaje/escritura son aceptables, pero el color es un poco amarillento

Ningún problema para su uso

Ningún problema para su uso

CARACTERÍSTICAS

- Marca en todo tipo de superficies, incluso bajo el agua.
- Resistente al agua, al sol y a temperaturas elevadas (200°C a -10°C).
- Fácil de aplicar, fácil de transportar.
- Marca desde cualquier ángulo o posición.
- Secado rápido (5-7 minutos).
- No tóxico. No inflamable.

Escibe y marca en cualquier superficie

No se resaca y no gotea

El marcaje no se distorsiona ni borra al mojarlo



CAJONES APILABLES



MODELO	MEDIDAS (AnchoxLargoxAlto)	UN	PRECIO/UD.
R-300	160 x 287 x 150	20	4,29 €
R-400	206 x 355 x 190	10	6,36 €
R-124	600 x 400 x 300	10	16,09 €

ACCESORIOS DE FUNDICION



**COLLARIN
CON TOMA**

CODIGO	DESCRIPCION	PRECIO
CDA0050	50 - 3/4	27,74 €
CDA0051	50 - 1	27,74 €
CDA0052	50 - 1 1/4	27,74 €
CDA0063	63 - 3/4	31,50 €
CDA0064	63 - 1	31,50 €
CDA0065	63 - 1 1/4	31,50 €
CDA0066	63 - 1 1/2	31,50 €
CDA0075	75 - 3/4	35,59 €
CDA0076	75 - 1	35,59 €
CDA0077	75 - 1 1/4	35,59 €
CDA0078	75 - 1 1/2	35,59 €
CDA0079	75 - 2	35,59 €
CDA0089	90 - 3/4	40,66 €
CDA0090	90 - 1	40,66 €
CDA0091	90 - 1 1/4	40,66 €
CDA0092	90 - 1 1/2	40,66 €
CDA0093	90 - 2	40,66 €
CDA0109	110 - 3/4	48,34 €
CDA0110	110 - 1	48,34 €
CDA0111	110 - 1 1/4	48,34 €
CDA0112	110 - 1 1/2	48,34 €
CDA0113	110 - 2	56,69 €
CDA0124	125 - 3/4	56,69 €
CDA0125	125 - 1	56,69 €
CDA0126	125 - 1 1/4	56,69 €
CDA0127	125 - 1 1/2	56,69 €
CDA0128	125 - 2	59,63 €
CDA0129	125 - 2 1/2	58,94 €
CDA0130	125 - 3	65,57 €
CDA0140	140 - 1	65,57 €

CODIGO	DESCRIPCION	PRECIO
CDA0141	140 - 1 1/4	65,57 €
CDA0142	140 - 1 1/2	65,57 €
CDA0143	140 - 2	65,57 €
CDA0144	140 - 2 1/2	65,57 €
CDA0145	140 - 3	65,57 €
CDA0160	160 - 1	73,28 €
CDA0161	160 - 1 1/4	73,28 €
CDA0162	160 - 1 1/2	73,28 €
CDA0163	160 - 2	73,28 €
CDA0164	160 - 2 1/2	73,28 €
CDA0165	160 - 3	73,28 €
CDA0200	200 - 1	88,24 €
CDA0201	200 - 1 1/4	88,24 €
CDA0202	200 - 1 1/2	88,24 €
CDA0203	200 - 2	88,24 €
CDA0204	200 - 2 1/2	88,24 €
CDA0205	200 - 3	88,24 €
CDA0253	250 - 2	161,15 €
CDA0255	250 - 3	161,15 €
CDA0313	315 - 2	186,64 €
CDA0315	315 - 3	186,64 €



**COLLARIN
UNION**

CODIGO	DESCRIPCION	PRECIO
AG05040	48-59,5 mm	32,06 €
AG05050	58-72 mm	53,00 €
AG05065	72-85 mm	59,22 €
AG05080	88-102 mm	81,54 €
AG05100	107-128 mm	91,55 €
AG05125	125-140 mm	99,47 €
AG05126	138-154 mm	101,92 €
AG05150	158-182 mm	132,42 €
AG05175	185-200 mm	149,34 €
AG05200	213-235 mm	162,64 €
AG05201	230-247 mm	207,07 €
AG05225	250-257 mm	194,78 €
AG05250	272-289 mm	242,94 €
AG05300	315-332 mm	270,04 €
AG05302	332-349 mm	284,92 €

TUBERÍAS Y ACCESORIOS

TUBO EN BARRA

Referencia	DN x ESP. (mm)	L (m)	U/B	m/B	€/m
PBP.TB1558	15 x 1.7	5,8	20	116	2,213
PBP.TB2258	22 x 2.0	5,8	10	58	3,740
PBP.TB2858	28 x 2.5	5,8	5	29	5,598



TUBO EN ROLLO

Referencia	DN x ESP. (mm)	L (m)	U/B	m/B	€/m
PBP.TR1500	15 x 1.7	100	1	100	2,146
PBP.TR1550	15 x 1.7	50	1	50	2,199
PBP.TR1525	15 x 1.7	25	1	25	2,199
PBP.TR2250	22 x 2.0	50	1	50	3,740
PBP.TR2225	22 x 2.0	25	1	25	3,740
PBP.TR2825	28 x 2.5	25	1	25	5,584



MANGUITO

Referencia	DN	U/B	U/C	€/m
PBP.M15	15	10	140	1,901
PBP.M22	22	5	90	2,390
PBP.M28	28	5	45	3,563



REDUCCIÓN HH

Referencia	DN	U/B	U/C	€/Unid.
PBP.RH2215	22-15	10	120	2,836



REDUCCIÓN MH

Referencia	DN	U/B	U/C	€ / Unid.
PBP.RM2215	22-15	10	150	2,261
PBP.RM2822	28-22	10	100	3,104



CODO

Referencia	DN	U/B	U/C	€ / Unid.
PBP.C15	15	10	140	2,347
PBP.C22	22	10	80	2,976
PBP.C28	28	5	40	4,261



TE IGUAL

Referencia	DN	U/B	U/C	€ / Unid.
PBP.T15	15	10	80	3,423
PBP.T22	22	10	50	4,317
PBP.T28	28	5	25	5,603



TE REDUCCIÓN CENTRAL

Referencia	DN	U/B	U/C	€ / Unid.
PBP.TRC2215	22-15-22	5	50	4,276
PBP.TRC2815	28-15-28	5	30	5,546
PBP.TRC2822	28-22-28	5	30	5,546



TE REDUCCIÓN LATERAL

Referencia	DN	U/B	U/C	€ / Unid.
PBP.TRL2215	22-22-15	5	50	4,276



TE DOBLE REDUCCIÓN

Referencia	DN	U/B	U/C	€ / Unid.
PBP.TDR2215	22-15-15	5	70	4,276



COLECTOR 4 TOMAS

Referencia	DN	U/B	U/C	€ / Unid.
PBP.C42215	22-4 x (15)-22	5	20	10,787



COLECTOR 22-15-15-22

Referencia	DN	U/B	U/C	€ / Unid.
PBP.COLIGU15	22-2 x (15)-22	5	30	5,893



TAPÓN

Referencia	DN	U/B	U/C	€ / Unid.
PBP.TAP15	15	10	300	1,761

PBP.TAP22	22	10	180	2,306
-----------	----	----	-----	-------



TAPÓN INSERCIÓN

Referencia	DN	U/B	U/C	€ / Unid.
PBP.TAPI15	15	100	2500	0,531

PBP.TAPI22	22	100	1800	0,572
------------	----	-----	------	-------

PBP.TAPI28	28	30	800	0,866
------------	----	----	-----	-------



CASQUILLO METÁLICO

Referencia	DN	U/B	U/C	€ / Unid.
PBP.CQ15	15	50	1500	0,343
PBP.CQ22	22	50	800	0,424
PBP.CQ28	28	50	400	0,862



CASQUILLO PLÁSTICO

Referencia	DN	U/B	U/C	€ / Unid.
PBP.CQ15P	15	50	1500	0,219
PBP.CQ22P	22	50	700	0,274



MANGUITO ROSCA HEMBRA

Referencia	DN	U/B	U/C	€ / Unid.
PBP.MR1512	15 x 1/2"	10	60	5,747
PBP.MR2212	22 x 1/2"	10	50	7,005
PBP.MR2234	22 x 3/4"	5	40	6,909
PBP.MR2834	28 x 3/4"	5	25	9,828
PBP.MR2801	28 x 1"	5	25	9,280



ENTRONQUE ROSCA MACHO

Referencia	DN	U/B	U/C	€ / Unid.
PBP.ER1512	15 x 1/2"	10	80	4,971
PBP.ER2212	22 x 1/2"	10	60	6,101
PBP.ER2234	22 x 3/4"	10	50	6,112
PBP.ER2834	28 x 3/4"	5	25	9,460
PBP.ER2801	28 x 1"	5	25	9,393



MANGUITO ROSCA HEMBRA MÓVIL

Referencia	DN	U/B	U/C	€ / Unid.
PBP.MM1512	15 x 1/2"	10	100	9,024
PBP.MM2234	22 x 3/4"	10	70	9,782



CODO FIJACIÓN ROSCA HEMBRA

Referencia	DN	U/B	U/C	€ / Unid.
PBP.CF1512	15 x 1/2"	10	60	6,940
PBP.CF2212	22 x 1/2"	10	40	8,411



CODO ROSCA HEMBRA

Referencia	DN	U/B	U/C	€ / Unid.
PBP.CR1512	15 x 1/2"	10	60	6,327
PBP.CR2212	22 x 1/2"	10	40	7,634
PBP.CR2234	22 x 3/4"	5	30	7,812
PBP.CR2801	28 x 1"	5	20	14,479



CODO PLACA

Referencia	DN	U/B	U/C	€ / Unid.
PBP.CP1512	15 x 1/2"	10	40	7,660
PBP.CP2212	22 x 1/2"	5	30	10,106



CODO ROSCA HEMBRA MÓVIL

Referencia	DN	U/B	U/C	€ / Unid.
PBP.CM1512	15 x 1/2"	10	100	9,782



TE ROSCA HEMBRA

Referencia	DN	U/B	U/C	€ / Unid.
PBP.TR1512	15 x 1/2"	10	30	8,636
PBP.TR2212	22 x 1/2"	5	25	9,888



CODO METÁLICO EXTRAÍBLE

Referencia	DN	U/B	U/C	€ / Unid.
PBP.CE1512	15 x 1/2"	1	25	9,232



ENTRONQUE TRANS. S/ PIEZA ROSCA MACHO

Referencia	DN	U/B	U/C	€ / Unid.
PBP.ET1512	15 x 1/2"	10	50	3,777
PBP.ET2234	22 x 3/4"	10	40	5,956



MANGUITO TRANSI. S/ PIEZA ROSCA HEMBRA

Referencia	DN	U/B	U/C	€ / Unid.
PBP.MT1512	15 x 1/2"	10	40	4,721
PBP.MT2234	22 x 3/4"	10	30	5,956



VALVULERIA

VÁLVULA BOLA

Referencia	DN	U/B	U/C	€ / Unid.
PBP.VB15	15	5	20	16,593
PBP.VB22	22	5	15	22,726



VÁLVULA BOLA METÁLICA EMPOTRAR

Referencia	DN	U/B	U/C	€ / Unid.
PBP.VE15	15	1	20	15,967
PBP.VE22	22	1	15	18,394
PBP.VE28*	28	1	8	85,139



* Precio inclui Regulación Maneta

ALARGADOR PARA VÁLVULA DE EMPOTRAR

Referencia	Descripción	U/B	€ / Unid.
PBP.ALARG1525	Para válvulas de ø 15-25 mm	1	6,542



REG. MANETA PARA VÁLV. DE EMPOTRAR C/FLORÓN

Referencia	Descripción	U/B	U/C	€ / Unid.
PBP.RM	Para válvulas de ø 15-25 mm	1	50	8,291



REG. POMO PARA VÁLV. DE EMPOTRAR C/FLORÓN

Referencia	Descripción	U/B	U/C	€ / Unid.
PBP.RP	Para válvulas de ø15-25 mm	1	50	7,199



REG. OCULTA PARA VÁLV. DE EMPOTRAR C/FLORÓN

Referencia	Descripción	U/B	U/C	€ / Unid.
PBP.RO	Para válvulas de ø 15-25 mm	1	50	6,408



COLECTOR METALICO 3 TOMAS 15X3/4"

Referencia	DN	U/B	U/C	€ / Unid.
PBP.CMET3F	15 x 3/4" - Fria	1	8	37,398
PBP.CMET3C	15 x 3/4" - Caliente	1	8	37,398



COLECTOR METALICO 2 TOMAS 15X3/4"

Referencia	DN	U/B	U/C	€ / Unid.
PBP.CMET2F	15 x 3/4" - Fria	1	8	25,972
PBP.CMET2C	15 x 3/4" - Caliente	1	8	25,972



VÁLVULA DE COMPUERTA

Referencia	DN	U/B	U/C	€ / Unid.
PBP.VC15	15	1	20	19,918
PBP.VC22	22	1	15	23,727



REG. POMO PARA VÁLV. COMPUERTA C/ FLÓRON

Referencia	DN	U/B	U/C	€ / Unid.
PBP.RPVC1522	15-22	1	50	7,199



REG. OCULTA PARA VÁLV. COMPUERTA C/ FLÓRON

Referencia	DN	U/B	U/C	€ / Unid.
PBP.ROVC1522	15-22	1	50	6,408



REPUESTOS Y COMPLEMENTOS

JUNTA

Referencia	DN	U/B	€ / Unid.
PBP.JT15	15	100	0,233
PBP.JT22	22	100	0,274
PBP.JT28	28	100	0,343



ANILLO RETENCIÓN

Referencia	DN	U/B	€ / Unid.
PBP.AR15	15	100	0,233
PBP.AR22	22	100	0,274
PBP.AR28	28	100	0,411



ARO DISTANCIADOR

Referencia	DN	U/B	€ / Unid.
PBP.ARO15	15	100	0,150
PBP.ARO22	22	100	0,192
PBP.ARO28	28	100	0,247



HEMBRA PARA CONEXIÓN

Referencia	DN	U/B	U/C	€ / Unid.
PBP.TR15	15	500	500	0,545
PBP.TR22	22	300	300	0,881
PBP.TR28	28	120	120	1,021

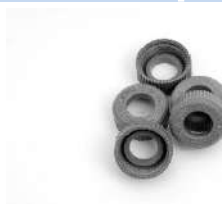

DISTANCIADOR COM TORNILLOS

Referencia	€ / Unid.
PBP.DT	0,759



ABRAZADERA SIMPLE CON TACO

Referencia	DN	U/B	€ / BOLSA
PBP.AS15/16	15-16	100	28,371
PBP.AS22	22	100	31,306
PBP.AS28	28	50	20,545



ABRAZADERA DOBLE COM TACO

Referencia	DN	U/B	€ / BOLSA
PBP.AD15/16	15-16	100	36,573
PBP.AD22	22	50	21,523
PBP.AD28	28	50	29,839



ABRAZADERA CIERRE NYLON

Referencia	DN	U/B	€ / BOLSA
PBP.ACN15	15	100	23,008
PBP.ACN22	22	100	28,726
PBP.ACN28	28	50	19,550



ABRAZADERA CLICK

Referencia	DN	U/B	€ / BOLSA
PBP.AC15	15	100	19,682
PBP.AC2022	20-22	100	25,800
PBP.AC28	28	50	17,822



ABRAZADERA CLIP ESPECIAL ALTAS TEMPERATURAS

Referencia	DN	U/B	€ / BOLSA
PBP.ACAT1415	14-15	100	27,938
PBP.ACAT2022	20-22	100	35,909
PBP.ACAT28	28	50	22,970



TIJERAS CORTATUBOS

Referencia	DN	U/B	U/C	€ / Unid.
PBP.TISPF	15-28	1	30	29,790



LUBRICANTE 50g

Referencia	€ / Unid.
PBP.LUB	7,740



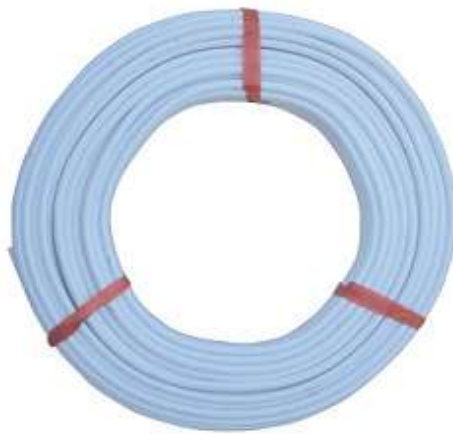

TUBO MULTICAPA

Pex / Al / Pex



Ventajas del Sistema Multipex

1. Tuberías Multicapa con aluminio soldado a tope (soudé bord-à-bord)

Las tuberías Multipex tienen su capa de aluminio soldada a tope lo que hace que la tubería tenga una mayor resistencia a presión y a las tensiones que se generan cuando las tuberías se doblan al curvarse. En las tuberías multicapa soldadas a tope la línea de soldadura de la capa de aluminio es precisamente el punto más fuerte de la lámina de aluminio.

Existen en el mercado otras tuberías multicapa en las cuales la capa de aluminio está solapada y soldada por ultrasonidos. Debemos llamar la atención sobre el hecho de que en este tipo de tuberías al no estar la capa de aluminio soldada a tope la línea de soldadura es el punto más débil de dicha capa de aluminio lo que se traduce en un inferior comportamiento en cuanto a resistencia a presión y a resistencia a los esfuerzos y tensiones generados en las curvas.



LEYENDA

- 1.- Pex
- 2.- Adhesivo
- 3.- Aluminio

Oferta Rollo
Oferta 500 metros

Rollo

MEDIDA	EMBALAJE	CODIGO	PRECIO €/ m	PRECIO €/ m	PRECIO €/ m
16 x 2	100	101.16100	1,19	1,15	1,10
18 x 2	100	101.18100	1,42	1,36	1,31
20 x 2	100	204MUL20100	1,58	1,52	1,45
25 x 2,5	50	101.25050	2,13	2,05	1,94



Barra

MEDIDA	EMBALAJE	CODIGO	PRECIO €/ m
16 x 2	20		1,60
20 x 2	20		2,10
25 x 2,5	20		2,93

Rollo con aislante 6 mm

Oferta 1000 metros

MEDIDA	EMBALAJE	CODIGO	PRECIO €/ m	PRECIO €/ m
16 x 2	100	264MULP1630	1,99	1,91
20 x 2	100	264MULP2034	2,63	2,52
25 x 2,5	50		4,29	4,11

Color ROJO y AZUL.

ART. 900**MANGUITO MACHO**

MEDIDA	UN	PRECIO
16 x 1/2"	10	2,42 €
18 x 1/2"	10	3,30 €
20 x 1/2"	10	3,71 €
20 x 3/4"	10	3,90 €
25 x 3/4"	10	6,12 €
25 x 1"	10	6,59 €

ART. 901**MANGUITO DOBLE**

MEDIDA	UN	PRECIO
16 x 16	10	3,58 €
18 x 18	10	5,83 €
20 x 20	10	5,99 €
25 x 25	10	10,61 €

ART. 902**MANGUITO HEMBRA**

MEDIDA	UN	PRECIO
16 x 1/2"	10	2,42 €
18 x 1/2"	10	3,30 €
20 x 1/2"	10	3,57 €
20 x 3/4"	10	4,12 €
25 x 3/4"	10	4,14 €

ART. 903**CODO DOBLE**

MEDIDA	UN	PRECIO
16 x 16	10	3,94 €
18 x 18	10	5,83 €
20 x 20	10	6,07 €
25 x 25	10	9,71 €

ART. 904**CODO MACHO**

MEDIDA	UN	PRECIO
16 x 1/2"	10	3,25 €
18 x 1/2"	10	3,96 €
20 x 3/4"	10	4,98 €
25 x 3/4"	10	7,12 €

ART. 905**CODO HEMBRA**

MEDIDA	UN	PRECIO
16 x 1/2"	10	3,27 €
20 x 1/2"	10	4,89 €
20 x 3/4"	10	5,57 €
25 x 3/4"	10	7,75 €

ART. 906**CODO PLACA HEMBRA**

MEDIDA	UN	PRECIO
16 x 1/2"	10	4,11 €
20 x 1/2"	10	5,71 €

ART. 907**TE INTERMEDIA**

MEDIDA	UN	PRECIO
16 x 16	10	5,60 €
18 x 18	10	8,54 €
20 x 20	10	8,86 €
25 x 25	10	17,43 €

ART. 909**TE HEMBRA**

MEDIDA	UN	PRECIO
16 x 1/2"	10	5,26 €
18 x 1/2"	10	8,59 €
20 x 3/4"	10	9,59 €
25 x 3/4"	10	11,69 €

Racores modulares de apriete

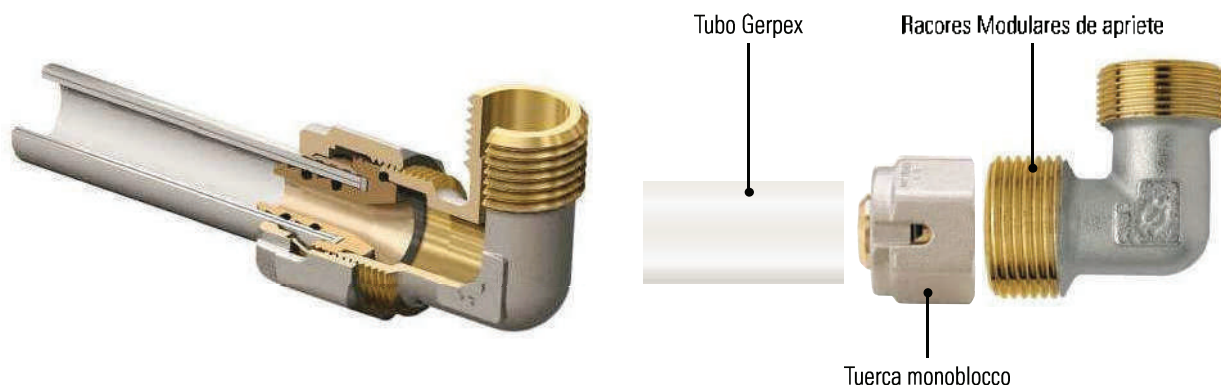

Características técnicas y de fabricación

El uso de los racores de apriete hace que la instalación sea rápida y sencilla y, sobre todo, que se pueda realizar con un equipamiento mínimo. La rosca de los racores 24x19 (o 32x1,5) permite usar un único tipo de racores acoplables a tuercas de diferentes tamaños, racionalizando así el almacén. La estanquidad hidráulica queda garantizada mediante el sistema con 3 O-Rings y abrazadera dentada para tubos. Todos los racores están dotados de su correspondiente anillo de PTFE que aísla eléctricamente el aluminio del racor de latón.

Detalles de fabricación

La tuerca monoblocco para tubo multicapa se suministra con sus componentes (tuerca, abrazadera y adaptador) ya ensamblados y listos para la inserción del tubo. La abertura presente en la tuerca permite verificar que el racor se ha introducido hasta el tope.

Construcción

Cuerpo UNI EN 12165 CW617N**

Conexión Hembra y Macho

Rosca GAS ISO 228/1 (DIN 259)

** Niquelado solo sobre superficies que no estén en contacto con los fluidos transportados; disponibilidad artículos en esta versión hasta agotar existencia de los correspondientes artículos en la versión completamente niquelada.

Gama

Racores de 1/2" y 3/4" con conexión 24x19

Racores de 3/4" y 1" con conexión 32p1,5

Racores dobles y triples con conexión 24x19 y 32p1,5

La rosca 24x19 permite la conexión de tubos de cobre, plástico o multicapa utilizando un racor estándar que se acopla a la junta específica para el tubo utilizado.

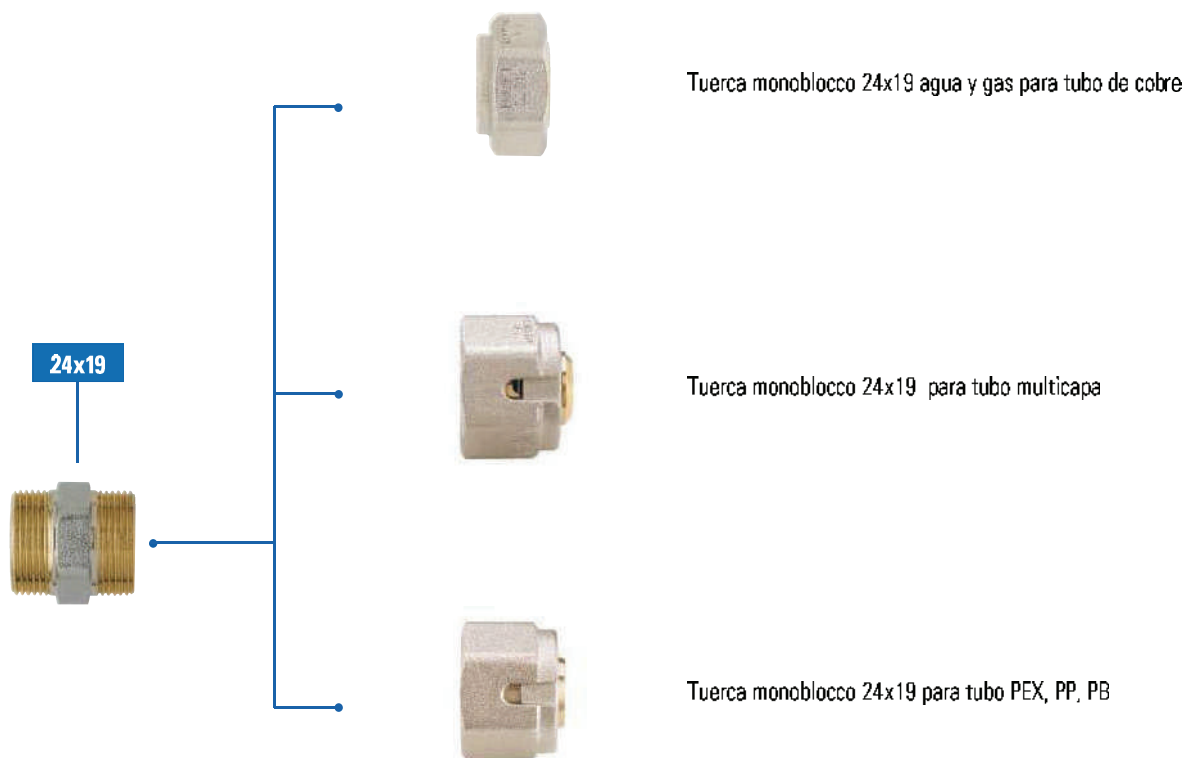

Monoblocco cobre

EMMETI
BRUNNEN

Tuerca 24x19 para tubo de cobre

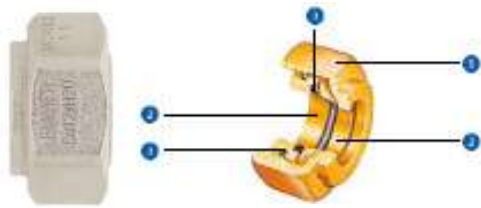

Medida	Conexión	Par máximo de apriete (Nm)	Ud/Caja	Código	€/ Ud.
10	24 x 19	30 – 35	50	01321410	2,59
12	24 x 19	35 – 40	50	01321412	2,54
14	24 x 19	40 – 45	50	01321414	2,44
15	24 x 19	40 – 45	50	01321415	2,44
16	24 x 19	45 – 50	50	01321416	2,31
18 tuerca standard	24 x 19	50 – 55	20	01321320	2,35
Tapón ciego	24 x 19	30 – 35	20	01321460	3,07

Aplicaciones

Las tuercas Emmeti Monoblocco son el sencillo y moderno complemento de las válvulas, de los detentores y de los colectores de distribución de la serie Poker, Tris 1 - 2 y 3, Monoris, Modular, Topway, Mixer y Multiplex con conexiones para tubo liso.

La ventaja del cierre Monoblocco está en la posibilidad de tener juntos en el interior de la tuerca, los cuatro componentes de la tradicional tuerca con ovalillo evitando así, cualquier posible error de montaje y pérdida de alguno de sus componentes. Disponibles para tubos del Ø 10 al Ø 16.

Construcción

- 1 Tuerca en latón ST UNI EN 12165 CW 617 N niquelado
- 2 Componentes metálicos en latón TN UNI EN 12164 CW 614 N
- 3 O-ring de estanquidad en NBR

Par máximo de apriete: 30 Nm

Presión máxima: 10 bar

Temperatura máxima: 100 °C

Instalación

El montaje de las tuercas se efectúa introduciendo la Monoblocco en el tubo limpio de rebaba o sin bordes cortantes en la extremidad (el o-ring está ya lubricado para esta operación), introducimos después el terminal del tubo hasta el tope, alineando los tubos y apretando la tuerca con la llave fija.

Monoblocco multicapa

EMMETI
BRUNNEN

Tuerca para tubo multicapa 24x19 y Eurocono

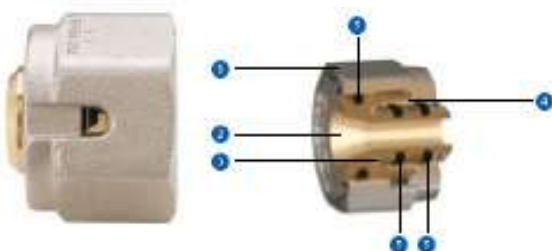

NEW

Medida	Conexión	Ud/Caja	Código	€/ Ud.
12 x 1,6	24 x 19	20	28100355	6,08
14 x 2	24 x 19	20	28100356	3,78
16 x 2	24 x 19	50	28100358	3,67
16 x 2,25	24 x 19	20	28100360	3,61
18 x 2	24 x 19	50	28100364	3,72
20 x 2	24 x 19	50	28100366	3,67
20 x 2,5	24 x 19	20	28110218	7,34
25 x 2,5	M32 x 1,5	8	9505R938	7,41
26 x 3	M32 x 1,5	8	28100368	7,17

M32x1,5 solo para racores modulares

Construcción

- 1 Tuerca UNI EN 12165 CW 617 N
- 2 Adaptador UNI EN 12164 CW 614 N
- 3 Anillo PTFE
- 4 Ojiva dentada aprietatubo, cortada UNI EN 12164 CW 614 N
- 5 O-ring de estanquidad EPDM

Par máximo de apriete: 30 Nm

Presión máxima: 10 bar

Temperatura máxima: 100 °C

Monoblocco PEX-PP-PB

Tuerca 24x19 y Eurocono para tubo en plástico PEX, PP, PB

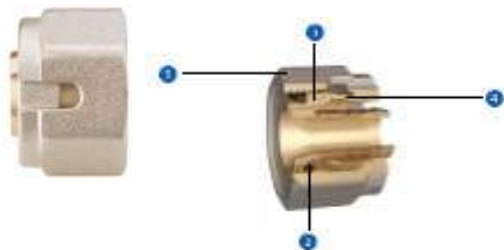

Construcción

- 1 Tuerca UNI EN 12165 CW 617 N
- 2 O-ring de estanqueidad EPDM
- 3 Adaptador UNI EN 12164 CW 614 N
- 4 Ojiva dentada aprietatubo, cortada UNI EN 12164 CW 614 N

Par máximo de apriete: 30 Nm

Presión máxima: 10 bar

Temperatura máxima: 100 °C

Medida	Conexión	Ud/Caja	Código	€/ Ud.
12 x 1	24 x 19	20	28110100	3,42
12 x 2	24 x 19	20	28110106	3,42
15 x 1,7	24 x 19	20	28110112	3,27
16 x 1,5	24 x 19	20	28110116	3,36
16 x 1,8	24 x 19	40	6239R916	3,94
16 x 2	24 x 19	20	28110118	3,37
16 x 2,2	24 x 19	20	28110120	4,49
17 x 2	24 x 19	20	28110122	3,38
20 x 2	24 x 19	20	28110446	4,44
25 x 2,3	M32 x 1,5	8	28100382	8,65

(*) Polibutileno

Para el uso de las tuercas Emmeti para tubo de polibutileno, es necesario la utilización de los insertos de refuerzo para el tubo suministrados por el fabricante del tubo.

Llave poligonal abierta CH 27 - 30



Medida	UN	Código	€/Ud
CH 27-30	1	01306058	67,71



Racores modulares de apriete Gerpep

Racor recto hembra, niquelado



Medida	Conexión	UN	Código	€ / Ud.
1/2"	24 x 19	50	1330K804	2,22
3/4"	24 x 19	30	1330K807	3,43
3/4"	M32 x 1,5	25	1330K809	3,73
1"	M32 x 1,5	20	1330K811	4,10

Racor recto macho, niquelado



Medida	Conexión	UN	Código	€ / Ud.
1/2"	24 x 19	50	1331K804	2,24
3/4"	24 x 19	30	1331K807	3,34
3/4"	M32 x 1,5	25	1331K809	3,87
1"	M32 x 1,5	20	1331K811	3,89

Racor recto doble, niquelado



Medida	Conexión	UN	Código	€ / Ud.
20 x 20	24 x 19	50	1332K831	2,24
26 x 26	M32 x 1,5	25	1332K833	3,89

Codo hembra, niquelado



Medida	Conexión	UN	Código	€ / Ud.
1/2"	24 x 19	25	1333K804	3,83
3/4"	24 x 19	20	1333K807	4,64
3/4"	M32 x 1,5	12	1333K809	5,58
1"	M32 x 1,5	10	1333K811	6,74

Codo macho, niquelado



Medida	Conexión	UN	Código	€ / Ud.
1/2"	24 x 19	30	1334K804	3,49
3/4"	24 x 19	25	1334K807	4,10
3/4"	M32 x 1,5	15	1334K809	5,07
1"	M32 x 1,5	12	1334K811	6,05

Codo igual, niquelado



Medida	Conexión	UN	Código	€ / Ud.
20 x 20	24 x 19	30	1335K831	3,54
26 x 26	M32 x 1,5	15	1335K833	5,17



Racores modulares de apriete Gerpep

Te hembra, niquelado



Medida	Conexión	UN	Código	€/ Ud.
1/2"	24 x 19	20	1336K804	4,40
3/4"	24 x 19	12	1336K807	5,73
3/4"	M32 x 1,5	8	1336K809	7,11
1"	M32 x 1,5	6	1336K811	8,29

Te macho, niquelado



Medida	Conexión	UN	Código	€/ Ud.
1/2"	24 x 19	20	1337K804	4,10
3/4"	24 x 19	15	1337K807	5,29
3/4"	M32 x 1,5	8	1337K809	6,34
1"	M32 x 1,5	6	1337K811	7,60

Te triple, niquelado





Medida	Conexión	UN	Código	€/ Ud.
20 x 20	24 x 19	20	1338K854	4,10
26 x 26	M32 x 1,5	8	1338K856	6,51

Codo hembra con brida, niquelado





Medida	Conexión	UN	Código	€/ Ud.
1/2"	24 x 19	30	1339K804	4,93
3/4"	24 x 19	25	1339K807	6,12

Racor Movil	MEDIDAS	ARTICULO	UN	PRECIO
				UD.
	16 x 2.0 x 1/2"	KRM 1612	50	3,00 €
	18 x 2.0 x 1/2"	KRM 1812	50	3,73 €
	20 x 2.0 x 1/2"	KRM 2012	50	3,62 €
	20 x 2.0 x 3/4"	KRM 2034	50	4,63 €
	25 x 2.5 x 3/4"	KRM 2534	40	5,86 €
	25 x 2.5 x 1"	KRM 251	40	8,16 €
	32 x 3.0 x 1"	KRM 321	10	9,02 €

Racor Fijo Hembra	MEDIDAS	ARTICULO	UN	PRECIO
				UD.
	16 x 2.0 x 1/2"	KRH 1612	50	2,80 €
	18 x 2.0 x 1/2"	KRH 1812	50	3,11 €
	20 x 2.0 x 1/2"	KRH 2012	50	3,07 €
	20 x 2.0 x 3/4"	KRH 2034	50	4,56 €
	25 x 2.5 x 3/4"	KRH 2534	40	4,56 €
	25 x 2.5 x 1"	KRH 251	10	6,97 €
	32 x 3.0 x 1"	KRH 321	15	7,24 €

Racor Fijo Macho	MEDIDAS	ARTICULO	UN	PRECIO
				UD.
	16 x 2.0 x 3/8"	KRC 1638	50	2,18 €
	16 x 2.0 x 1/2"	KRC 1612	50	2,30 €
	16 x 2.0 x 3/4"	KRC 1634	50	3,30 €
	18 x 2.0 x 1/2"	KRC 1812	50	2,68 €
	20 x 2.0 x 1/2"	KRC 2012	50	2,60 €
	20 x 2.0 x 3/4"	KRC 2034	50	3,53 €
	25 x 2.5 x 3/4"	KRC 2534	40	4,51 €
	25 x 2.5 x 1"	KRC 251	20	6,18 €
	32 x 3.0 x 1"	KRC 321	20	7,55 €

Manguito Unión	MEDIDAS	ARTICULO	UN	PRECIO
				UD.
	16 x 2.0	KMU 1612	50	2,08 €
	18 x 2.0	KMU 1812	50	3,00 €
	20 x 2.0	KMU 2012	50	3,09 €
	25 x 2.5	KMU 251	40	5,34 €
	32 x 3.0	KMU 321	20	7,75 €

Manguito Reducido	MEDIDAS	ARTICULO	UN	PRECIO
				UD.
	18 - 16 x 2.0	KMR 1816	50	4,02 €
	20 - 16 x 2.0	KMR 2016	50	2,69 €
	20 - 18 x 2.0	KMR 2018	50	2,81 €
	25 x 2.5 - 16 x 2,0	KMR 2516	40	4,08 €
	25 x 2.5 - 20 x 2,0	KMR 2520	40	5,85 €
	32 x 3.0 - 20 x 2,0	KMR 3220	10	5,92 €
	32 x 3.0 - 25 x 2,5	KMR 3225	10	6,91 €

Codo	MEDIDAS	ARTICULO	UN	PRECIO
				UD.
	16 x 2.0	KC 16	50	2,53 €
	18 x 2.0	KC 18	50	3,67 €
	20 x 2.0	KC 20	40	3,67 €
	25 x 2.5	KC 25	30	6,69 €
	32 x 3.0	KC 32	20	9,80 €

Codo Terminal	MEDIDAS	ARTICULO	UN	PRECIO
				UD.
	16 x 2.0 x 1/2"	KTC 1612	50	3,84 €
	18 x 2.0 x 1/2"	KTC 1812	50	4,35 €
	20 x 2.0 x 1/2"	KTC 2012	50	4,32 €
	20 x 2.0 x 3/4"	KTC 2034	50	4,86 €
	25 x 2.5 x 3/4"	KTC 2534	40	6,15 €
	25 x 2.5 x 1"	KTC 251	10	8,90 €
	32 x 3.0 x 1"	KTC 321	20	9,95 €

Codo Terminal	MEDIDAS	ARTICULO	UN	PRECIO
				UD.
	16 x 2.0 x 1/2"	KCBF 1612	25	4,75 €
	18 x 2.0 x 1/2"	KCBF 1812	10	5,40 €
	20 x 2.0 x 1/2"	KCBF 2012	25	5,40 €
	20 x 2.0 x 3/4"	KCBF 2034	10	6,73 €
	25 x 2.5 x 3/4"	KCBF 2534	20	8,43 €

Codo Rosca Macho	MEDIDAS	ARTICULO	UN	PRECIO
				UD.
	16 x 2.0 x 1/2"	KCR 1612	50	3,50 €
	18 x 2.0 x 1/2"	KCR 1812	50	4,08 €
	20 x 2.0 x 1/2"	KCR 2012	50	4,85 €
	20 x 2.0 x 3/4"	KCR 2034	15	5,83 €
	25 x 2.5 x 3/4"	KCR 2534	30	6,61 €
	32 x 3.0 x 1"	KCR 321	10	9,72 €

Te Igual	MEDIDAS	ARTICULO	UN	PRECIO
				UD.
	16 x 2.0	KT 16	50	3,81 €
	18 x 2.0	KT 18	50	6,13 €
	20 x 2.0	KT 20	40	5,40 €
	25 x 2.5	KT 25	30	9,72 €
	32 x 3.0	KT 32	20	14,77 €

Te Reducida	MEDIDAS	ARTICULO	UN	PRECIO
				UD.
	16 - 20 - 16	KT 16206	40	5,86 €
	18 - 16 - 16	KT 18166	40	4,82 €
	20 - 16 - 16	KT 20166	40	4,69 €
	20 - 16 - 20	KT 20160	40	7,30 €
	20 - 18 - 20	KT 20180	40	5,34 €
	20 - 20 - 16	KT 20206	40	5,14 €
	20 - 25 - 20	KT 2X25X	10	8,51 €
	25 - 16 - 20	KT 2516X	10	7,73 €
	25 - 16 - 25	KT 25165	10	10,17 €
	25 - 18 - 25	KT 25185	10	9,09 €
	25 - 20 - 16	KT 252X1	10	7,73 €
	25 - 20 - 20	KT 252XX	10	7,89 €
	25 - 20 - 25	KT 252X5	10	8,75 €
	25 - 25 - 20	KT 2525X	20	10,17 €
	32 - 16 - 32	KT 32162	20	12,83 €
	32 - 20 - 32	KT 32202	20	12,83 €
32 - 25 - 32	KT 32252	20	14,00 €	
32 - 25 - 25	KT 32255	10	13,02 €	

Te Rosca Hembra	MEDIDAS	ARTICULO	UN	PRECIO
				UD.
	16 x 2.0 x 1/2"	KSM 1612	50	5,52 €
	20 x 2.0 x 1/2"	KSM 2X34	30	6,03 €
	25 x 2.5 x 3/4"	KSM 2534	10	12,71 €

Cuerpo Llave Esfera	MEDIDAS	PRECIO
		UD.
	16 x 2.0	13,61 €
	20 x 2.0	13,80 €
	25 x 2.5	23,06 €
	32 x 3.0	29,16 €

Cuerpo Llave en "U"	MEDIDAS	PRECIO
		UD.
	16 x 2.0	19,05 €
	20 x 2.0	19,05 €
	25 x 2.5	24,06 €

Cuerpo Llave Soleta	MEDIDAS	PRECIO
		UD.
	Mando Pomo	6,57 €
	Mando Palanca	6,33 €
	Mando Oculto	5,52 €

¡Lo conseguimos!

Le presentamos el nuevo accesorio ixPress2, la segunda generación del accesorio ixPress, diseñado y fabricado íntegramente en España por Industrial Blansol y ahora con:

- Prestaciones mejoradas
- Diseño a prueba de error humano
- El mejor precio del mercado

El nuevo ixPress2 le permitirá realizar sus instalaciones de forma rápida y segura, olvidando las engorrosas herramientas de montaje y a un precio increíble. El nuevo diseño evita los errores humanos al impedir que se pueda introducir la tubería si antes ésta no ha sido calibrada adecuadamente, evitando un problema habitual en los accesorios press-fittings.

¿Así de simple?

¿Me puedo fiar de un sistema de montaje tan sencillo, que no precisa ni herramientas ni engorrosas explicaciones?

¡Por supuesto!

Detrás de esta aparente sencillez, hay todo un trabajo de investigación realizado por Industrial Blansol, aprovechando sus más de 30 años de experiencia en el diseño de accesorios para tuberías plásticas.

El nuevo sistema ixPress2 es una evolución mejorada respecto de la anterior generación, diseñada y fabricada íntegramente en España.

¿Cómo se monta?

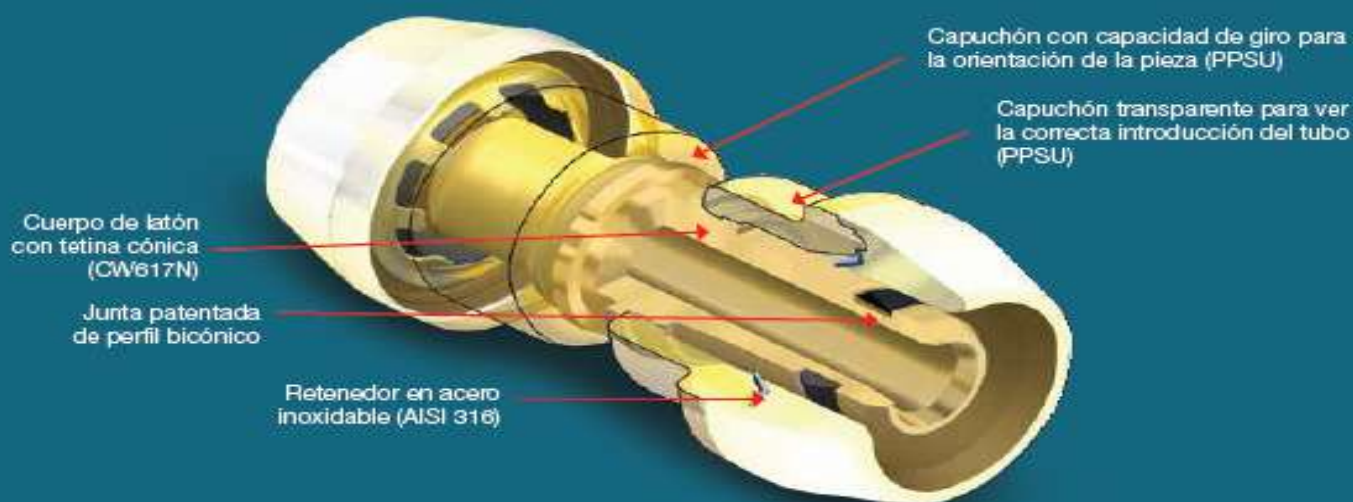

ixPress2

25 años de garantía

INDUSTRIAL BLANSOL, S.A. mediante póliza de responsabilidad civil de producto garantiza hasta un máximo de 1,5 millones de euros (1.500.000 €) y por un plazo de 25 años los eventuales daños ocasionados por el empleo de los SISTEMAS BARBI en cualquier país del mundo excepto U.S.A. y Canadá imputables a:

- Defectos en la concepción y diseño del producto.
- Defectos en la fabricación del producto.

La presente GARANTÍA NO SERÁ VALIDA en los siguientes casos:

- Incumplimiento de las advertencias indicadas en nuestra documentación técnica.
- Utilización de tuberías no fabricadas por nuestra empresa.



Instrucciones de montaje

1. Cortar el tubo con una tijera adecuada, asegurándose de que el corte sea limpio.
2. Verificar que el extremo del tubo esté libre de rebabas.
3. Para el ixPress1 calibrar usando el calibrador de plástico.
4. Para el ixPress2 calibrar utilizando siempre el calibrador Kalistar.
5. Utilizar exclusivamente tuberías Barbi.

**RACOR MACHO**

Medida	Familia	Subfamilia	Artículo	UN	€ / Ud
16 x3/8"	IXPR	AI	KRC1638	40	5,54
16 x1/2"	IXPR	AB	KRC1612	40	5,59
20 x1/2"	IXPR	AB	KRC2012	40	6,87

**RACOR HEMBRA**

Medida	Familia	Subfamilia	Artículo	UN	€ / Ud
16 x3/8"	IXPR	AI	KRH1638	40	6,49
16 x1/2"	IXPR	AB	KRH1612	40	6,49
20 x1/2"	IXPR	AB	KRH2012	40	7,54

**MANGUITO**

Medida	Familia	Subfamilia	Artículo	UN	€ / Ud
16	IXPR	AB	KMU16	40	4,53
20	IXPR	AB	KMU20	40	6,15

**CODO**

Medida	Familia	Subfamilia	Artículo	UN	€ / Ud
16	IXPR	AB	KC16	30	4,95
20	IXPR	AB	KC20	40	6,67

**CODO TERMINAL**

Medida	Familia	Subfamilia	Artículo	UN	€ / Ud
16 x1/2"	IXPR	AB	KTC1612	40	6,87
20 x1/2"	IXPR	AB	KTC2012	40	7,94
20 x 3/4"	IXPR	AB	KTC2034	35	11,88

**CODO TERMINAL**

Medida	Familia	Subfamilia	Artículo	UN	€ / Ud
16 x1/2"	IXPR	AB	KCR1612	40	8,12
20 x1/2"	IXPR	AI	KCR2012	40	9,09

**CODO BASE FIJACION CORTO**

Medida	Familia	Subfamilia	Artículo	UN	€ / Ud
16 x1/2"	IXPR	AB	KCBF162	30	11,00
20 x1/2"	IXPR	AB	KCBF202	30	11,37

**CODO BASE FIJACION CORTO**

Medida	Familia	Subfamilia	Artículo	UN	€ / Ud
16 x1/2"	IXPR	AB	KSH1612	30	11,31
20 x1/2"	IXPR	AB	KSH2012	25	13,81

**TE IGUAL Y REDUCIDA**

Medida	Familia	Subfamilia	Artículo	UN	€ / Ud
16	IXPR	AB	KT16	30	7,70
20	IXPR	AB	KT20	25	10,22
20-16-16	IXPR	AB	KT20166	30	8,76
20-16-20	IXPR	AB	KT20160	30	9,71
20-20-16	IXPR	AB	KT20206	30	9,96

**CALIBRADOR KALISTAR IXPRESS 2 (interior+exterior)**

Medida	Familia	Subfamilia	Artículo	UN	€ / Ud
16-20x2,0-25	IXPR	HT	K162025	1	99,14

Suministros
FONTANA, S.L.



Verdeal, 77-A
Tel.: 986 32 71 31
Fax: 986 32 71 40
sumfontana@terra.es
36957 Domayo (Moaña)
Pontevedra

Sistema de prensar en acero inoxidable AISI 316 L

INOXPRES

DVGW Zertifizierungsstelle	WRAS Water Regulations Advisory Scheme
DVGW Drinking Water	DNV
ÖVGW ÖSTERREICHISCHE VERBANDSGEMEINSCHAFT FÜR GAS- UND WASSERFACH	SITAC Swedish Institute for Technical Approval in Construction
ÖVGW ÖSTERREICHISCHE VERBANDSGEMEINSCHAFT FÜR GAS- UND WASSERFACH	SVGW SSIGE
CSTB	kiwa Partner for progress
ETA DANMARK	VdS

TUBERIA DE ACERO INOX Aisi 304

Ø	ESPESOR	PRECIO
12	0,6	1,58 €
15	0,6	1,78 €
18	0,7	2,58 €
22	0,7	3,22 €
28	0,8	4,78 €
35	1,0	7,47 €

CODIGO	€	CODIGO	€	CODIGO	€			
Curva 90HH 	20C90HH15	3,95	Te igual HHH 	20T15	6,99	Reducción MH 	20RE4228	10,18
	20C90HH18	4,66		20T18	7,58		20RE4235	8,72
	20C90HH22	5,96		20T22	8,72		20RE5415	18,63
	20C90HH28	7,58		20T28	11,05		20RE5418	18,09
	20C90HH35	12,24		20T35	14,52		20RE5422	15,11
	20C90HH42	19,23		20T42	18,63		20RE5428	11,65
	20C90HH54	24,43		20T54	25,30		20RE5435	11,75
	20C90HH76	66,30		20T76	93,00		20RE5442	12,24
	20C90HH88	81,41		20T88	98,85		20RE7642	28,17
20C90HH108	104,00	20T108	122,09	20RE7654	36,08			
Curva 90HM 	20C90HM15	4,12	Te reducida HHH 	20TR1815	7,58	Manguito sin tope 	20RE8854	41,00
	20C90HM18	4,66		20TR2215	8,18		20RE8876	54,65
	20C90HM22	5,85		20TR2218	8,45		20RE10854	47,67
	20C90HM28	7,58		20TR2815	9,91		20RE10876	61,37
	20C90HM35	11,65		20TR2818	10,18		20RE10888	63,38
	20C90HM42	18,04		20TR2822	10,51		20MST15	5,85
	20C90HM54	23,83		20TR3515	11,92		20MST18	6,45
	20C90HM76	58,12		20TR3518	12,24		20MST22	7,58
	20C90HM88	78,49		20TR3522	12,51		20MST28	8,72
20C90HM108	98,85	20TR3528	12,84	20MST35	9,32			
Curva 45HH 	20C45HH15	4,12	20TR4222	16,90	20MST42	10,51		
	20C45HH18	4,33	20TR4228	17,77	20MST54	15,11		
	20C45HH22	6,45	20TR4235	18,63	20MST76	81,41		
	20C45HH28	8,18	20TR5422	22,70	20MST88	93,00		
	20C45HH35	12,24	20TR5428	22,97	20MST108	104,65		
	20C45HH42	18,63	20TR5435	24,43	Racor dos piezas 	20R2P1515	15-1/2	7,31
	20C45HH54	25,62	20TR5442	26,16		20R2P1520	15-3/4	7,58
	20C45HH76	63,97	20TR7622	75,56		20R2P1815	18-1/2	8,18
	20C45HH88	75,56	20TR7628	76,75		20R291820	18-3/4	8,72
20C45HH108	98,85	20TR7635	77,89	20R2P2225		22-1"	11,05	
Curva 45HM 	20C45HM15	4,12	20TR7642	79,08		20R2P2832	28-1.1/4	13,38
	20C45HM18	4,55	20TR7654	81,41		20R2P3540	35-1.1/2	14,84
	20C45HM22	6,45	20TR8822	87,21		20R2P4250	42-2"	19,77
	20C45HM28	8,45	20TR8828	88,35		20R2P5450	54-2"	
	20C45HM35	11,92	20TR8835	90,68	20R2P5465	54-2.1/2	24,43	
	20C45HM42	18,31	20TR8842	93,00	Te hembra roscada 	20TH1515	15-1/2	8,18
	20C45HM54	22,70	20TR8854	96,53		20TH1815	18-1/2	8,45
	20C45HM76	55,85	20TR8876	104,65		20TH1820	18-3/4	9,05
	20C45HM88	72,69	20TR10822	106,98		20TH2215	22-1/2	9,64
20C45HM108	93,00	20TR10828	110,45	20TH2220		22-3/4	9,91	
Codo 90HH 	20CD90HH35	12,24	20TR10835	113,97		20TH2815	28-1/2	11,05
	20CD90HH42	19,23	20TR10842	116,24		20TH2820	28-3/4	11,38
Manguito HH 	20M15	2,93	20TR10854	122,09		20TH2825	28-1	16,79
	20M18	3,52	20TR10876	139,53		20TH3515	35-1/2	
	20M22	3,79	20TR10888	156,98	20TH3520	35-3/4	16,30	
	20M28	4,39	Reducción MH 	20RE1815	3,52	20TH3525	35-1"	17,33
	20M35	5,85		20RE2215	3,68	20TH4215	42-1/2	16,58
	20M42	7,69		20RE2218	3,79	20TH4220	42-3/4	19,23
	20M54	11,05		20RE2815	5,25	20TH5415	54-1/2	24,65
	20M76	37,21		20RE2818	5,53	20TH5420	54-3/4	26,16
	20M88	41,87		20RE2822	5,85	20TH5450	54-2"	36,62
	20M108	48,26		20RE3515	11,65	20TH5450	54-2"	36,62
				20RE3518	11,65	20TH7620	76-3/4	81,41
		20RE3522		7,58	20TH7650	76-2"	87,21	
		20RE3528		6,72	20TH8820	88-3/4	93,00	
		20RE4215		11,27	20TH8850	88-2"	98,85	
		20RE4218	11,27	20TH10820	108-3/4	110,45		
		20RE4222	10,18	20TH10850	108-2"	116,24		

CODIGO			€	CODIGO			€	CODIGO			€		
	Codo hembra	20CH1515	15-1/2	8,45		20UH1515	15-1/2	6,72		20EPDM15	0,07		
		20CH1520	15-3/4	10,56			20UH1520	15-3/4		8,45		20EPDM18	0,11
		20CH1815	18-1/2	9,32			20UH1815	18-1/2		7,31		20EPDM22	0,13
		20CH2220	22-3/4	11,05			20UH1820	18-3/4		8,50		20EPDM28	0,16
		20CH2825	28-1"	15,11			20UH2215	22-1/2		8,56		20EPDM35	0,20
		20CH3532	35-1.1/4	20,37			20UH2220	22-3/4		8,72		20EPDM42	0,26
	Codo macho	20CM1515	15-1/2	8,18		20AH1515	15-1/2	6,99		20VIT15	0,23		
		20CM1815	18-1/2	8,45			20AH1815	18-1/2		7,31		20VIT18	0,29
		20CM2220	22-3/4	10,18			20AH1820	18-3/4		9,91		20VIT22	0,41
		20CM2825	28-1"	13,98			20AH2215	22-1/2		7,58		20VIT28	0,47
		20CM3532	35-1.1/4	18,90			20AH2220	22-3/4		10,51		20VIT35	0,59
		20CM4240	42-1.1/2	25,62			20AH2820	28-3/4		11,65		20VIT42	0,99
	Codo placa	20CP1515	15-1/2	9,32		20R3P15		16,03		20DI15	46,53		
		20CP1815	18-1/2	9,91			20R3P18			18,63		20DI18	51,19
		20CP2220	22-3/4	11,38			20R3P22			20,37		20DI22	56,98
	Codo distan.	20CPD1515	15-1/2	9,48		20BA15		25,62		20TA15	4,93		
		20CPD1815	18-1/2	10,45			20BA18			26,76		20TA18	5,47
		20CPD2220	22-3/4	11,65			20BA22			29,09		20TA22	6,07
	Curva macho	20CUM3525	35-1"	27,41		20TC15		10,56		20CD15	5,85		
		20CUM3532	35-1.1/4	28,55			20TC18			11,38		20CD18	6,72
		20CUM4232	42-1.1/4	33,53			20TC22			12,78		20CD22	7,58
	Unión macho	20UM1515	15-1/2	6,45		20TC28		17,33		40AP1015	1,02		
		20UM1520	15-3/4	7,58			M6	0,26			40AP1018	1,06	
		20UM1815	18-1/2	6,99			M8	0,48			40AP1022	1,13	
		20UM1820	18-3/4	8,34			M10	0,80			40AP1028	1,21	
		20UM2215	22-1/2	8,07							40AP1035	1,30	
		20UM2220	22-3/4	8,72							40AP1042	1,41	
		20UM2225	22-1"	9,64							40AP1054	1,63	
		20UM2820	28-3/4	10,78							402AC065	3,79	
		20UM2825	28-1"	11,38							402AC080	4,28	
		20UM2832	28-1.1/4	12,84							402AC100	4,77	
		20UM3525	35-1"	12,24									
		20UM3532	35-1.1/4	13,98									
		20UM3540	35-1.1/2	15,71									
		20UM4232	42-1.1/4	15,71									
		20UM4240	42-1.1/2	16,30									
	20UM5440	54-1.1/2	18,63										
	20UM5450	54-2"	19,77										
	20UM7665	76-2.1/2	69,77										
	20UM8880	88-3"	104,65										
	Adaptador macho	20AM1515	15-1/2	6,99									
		20AM1815	18-1/2	7,26									
		20AM1820	18-3/4	8,99									
		20AM2215	22-1/2	8,72									
		20AM2220	22-3/4	9,32									
	20AM2820	28-3/4	10,56										

5.3.1 Profundidad

A continuación indicamos en la tabla las longitudes de introducción de las diferentes medidas para su marcaje:

Tamaño del accesorio	Profundidad de inserción	Tamaño del accesorio	Profundidad de inserción
15 mm	Aprox. 23 mm	35 mm	Aprox. 56,5 mm
18 mm	Aprox. 23 mm	42 mm	Aprox. 62 mm
22 mm	Aprox. 27 mm	54 mm	Aprox. 69 mm
28 mm	Aprox. 31 mm		

Tabla 2

5.3.2 Fijación de la tubería

Cualquier sistema de tubería deberá ser instalado para asegurar un mínimo de estrés sobre la línea, los tubos y accesorios. A continuación indicamos los máximos de separación de las abrazaderas de sujeción para estos sistemas:

Ø Tubo según BS 4127 y DVGW W541	Distancia mín. bridas tubo horizontal	Distancia mín. bridas tubo vertical	Distancia mín. entre 2 manguitos	Distancia mín. entre un manguito y un paso de pared
15 mm	1.200 mm	1.800 mm	10 mm	40 mm
18 mm	1.500 mm	2.100 mm	10 mm	40 mm
22 mm	1.800 mm	2.400 mm	10 mm	40 mm
28 mm	1.800 mm	2.400 mm	10 mm	50 mm
35 mm	2.400 mm	3.000 mm	50 mm	100 mm
42 mm	2.400 mm	3.000 mm	50 mm	100 mm
54 mm	2.700 mm	3.000 mm	50 mm	100 mm

5.4 Ver instrucciones de desmontaje en Tectite (pag. 41)



405 Clip Desmontaje



Medida	Ref.	UN	PRECIO
15	80401	5	1,93 €
18	80402	5	1,93 €
22	80403	5	2,67 €
28	80404	5	2,67 €

No 91

TS270 Manguito Union



Medida	Ref.	D	L	Un.	€
15	81411	15	49	10	7,39
18	81412	18	49	5	8,57
22	81413	22	58	5	9,82
28	81414	28	66	5	11,66

TS270g Manguito tubo - rosca hembra



Medida	Ref.	D	L	S	T	UN	€
15x1/2"	81438	15	40	24,5	1/2"	10	19,76
18x1/2"	81439	18	40	25	1/2"	5	21,56
18x3/4"	81440	18	43	32	3/4"	5	24,69
22x1/2"	81442	22	45	31,75	1/2"	5	24,51
22x3/4"	81441	22	47	32	3/4"	5	31,06
28 x 1"	81444	28	53	37,3	1"	2	35,94

TS301 Tapón



Medida	Ref.	D	L	UN	€
15	81480	15	27	10	10,35
18	81481	18	31	5	13,09
22	81482	22	34	5	16,25
28	81483	28	56,5	5	20,82

TS471g Codo 90° tubo rosca hembra placa

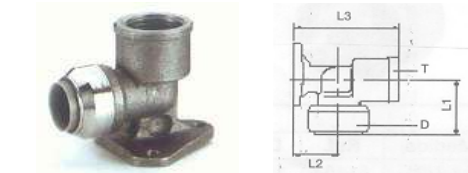

Medida	Ref.	D	L1	L2	L3	T	UN	€
15x1/2"	81434	15	26	20	34	1/2"	5	28,10
18x1/2"	81647	18	45	19	34	1/2"	5	31,18
22x3/4"	81675	22	53	22	38	3/4"	5	35,69

TS040 Curva 45° macho-hembra

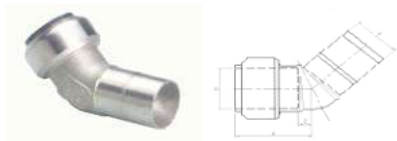

Medida	Ref.	D1	L1	UN	€
15	81683	15	33	10	13,01
18	81684	18	34	5	13,99
22	81685	22	41	5	15,01
28	81686	28	49	5	19,06

TS041 Curva 45° hembra-hembra

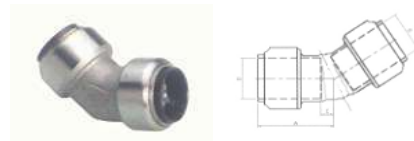

Medida	Ref.	D1	L1	UN	€
15	81676	15	33	10	13,27
18	81677	18	34	5	14,20
22	81678	22	41	5	16,73
28	81679	28	49	5	19,30

TS130 Te

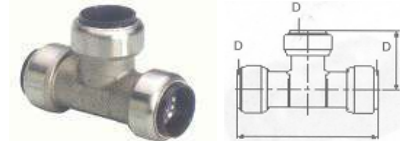

Medida	Ref.	D	L1	L2	UN	€
15	81446	15	62	31	10	20,31
18	81447	18	68	34	5	23,47
22	81448	22	82	41	5	24,61
28	81449	28	97	49	2	31,99

TS130 Te reducida



Medida	Ref.	D	L1	L2	T	UN	€
18x15x18	81690	18	15	60	31	5	22,08
22x15x22	81451	22	15	75	36	5	24,64
22x18x22	81562	22	18	78	32	2	25,71
28x15x28	81452	28	15	84	40	2	29,92
28x18x28	81623	28	18	87	39	2	31,22
28x22x28	81453	28	22	91	44	2	18,79

TS090g Codo 90° rosca hembra

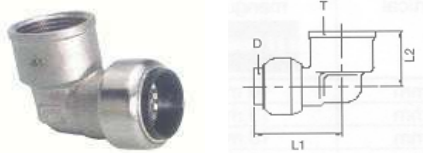

Medida	Ref.	D	L1	L2	T	UN	€
15x1/2"	81429	15	34	26	1/2"	10	23,34
18x1/2"	81497	18	36	26	1/2"	5	24,96
18x3/4"	81430	18	40	33	3/4"	5	31,94
22x3/4"	81431	22	42	33	3/4"	5	32,31
28 x 1"	81432	28	49	37	1"	2	37,45

TS090 Codo 90° hembra-hembra

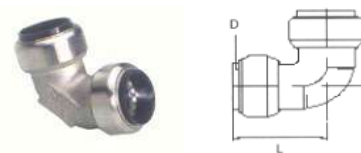

Medida	Ref.	D	L	UN	€
15	81416	15	33	10	12,81
18	81417	18	34	5	14,96
22	81418	22	41	5	15,87
28	81419	28	49	5	11,89

TS130g Te rosca hembra

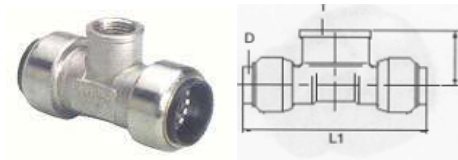

Medida	Ref.	D	L1	L2	T	UN	€
15x1/2x15	81459	15	69	25	1/2"	10	25,06
18x1/2x18	81696	18	70	28	1/2"	5	25,54
22x1/2x22	81697	22	76	28	1/2"	5	28,80
22x3/4x22	81626	22	78	30	3/4"	5	39,32
28x1/2x28	81698	28	68	32	1/2"	2	33,01

TS092g Codo 90° rosca macho

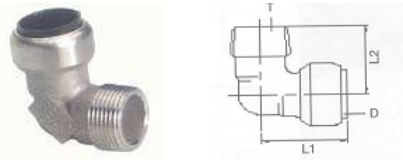

Medida	Ref.	D	L1	L2	T	UN	€
15x1/2"	81424	15	34	29	1/2"	10	20,30
18x1/2"	81674	18	34	34	1/2"	5	23,74
22x3/4"	81426	22	41	34	3/4"	5	31,01
28 x 1"	81427	28	49	42	1"	5	36,07

TS092 Codo 90° macho-hembra

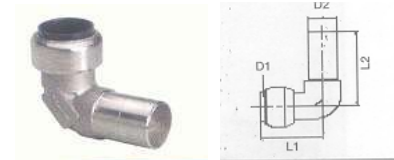

Medida	Ref.	D	L1	L2	UN	€
15	81420	15	34	44	10	13,60
18	81498	18	36	48	5	14,82
22	81421	22	42	50	5	16,63
28	81499	28	49	56,5	5	20,45

TS243g Manguito tubo-rosca macho



Medida	Ref.	D	L1	L2	T	UN	€
15x1/2	81463	15	40	24,5	1/2"	10	19,32
18x1/2	81464	18	40	25	1/2"	5	20,12
18x3/4	81465	18	43	32	3/1"	5	21,28
22x3/4	81467	22	47	31,75	3/4"	5	25,02
28x1	81469	28	53	37,3	1"	2	28,57

TUBERIA DE COBRE

OUTOKUMPO

TUBO COBRE DURO (Barra)		
CODIGO	Medidas	PRECIO
T121	12 x 1	6,82 €
T141	14 x 1	9,03 €
T151	15 x 1	8,45 €
T161	16 x 1	6,83 €
T181	18 x 1	8,88 €
T221	22 x 1	13,32 €
T281	28 x 1	17,09 €
T351	35 x 1	16,84 €
T421	42 x 1	20,52 €
	54 x 1,2	31,98 €

TUBO COBRE RECOCIDO (Rollo)		
CODIGO	Medidas	PRECIO
R121	12 x 1	7,32 €
R141	14 x 1	7,03 €
R151	15 x 1	9,06 €
R161	16 x 1	7,92 €
R181	18 x 1	8,31 €

Rollos de 50 metros

TUBO COBRE CROMADO (Rollo)		
CODIGO	Medidas	PRECIO
RC101	10 x 1	8,54 €
RC121	12 x 1	9,23 €

Rollos de 50 metros

ACCESORIOS LATON ROSCAR - SOLDAR

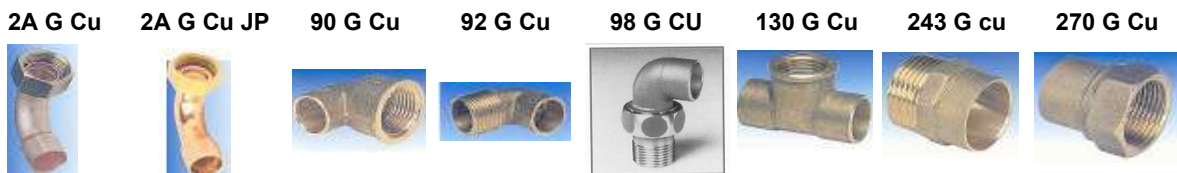

MEDIDA	ENV.	PRECIO	ENV.	PRECIO	ENV.	PRECIO	ENV.	PRECIO	ENV.	PRECIO	ENV.	PRECIO	ENV.	PRECIO	ENV.	PRECIO
3/8" - 10					25	1,35							25	0,68		
3/8" - 12	25	2,42			25	0,86					25	1,50	25	0,62	25	0,58
3/8" - 14					25	1,04	25	1,26			25	1,38	25	0,58	25	0,68
3/8" - 15					25	1,04	25	1,10			25	1,34	25	0,58	25	0,76
1/2" - 10					25	1,58							25	0,98	25	0,87
1/2" - 12	25	2,33	25	2,33	25	1,18	25	1,23	25	8,32	25	1,73	25	0,84	25	0,78
1/2" - 14	25	2,33	25	2,33	25	1,18	25	1,28	25	8,35	25	1,50	25	0,84	25	0,82
1/2" - 15	25	2,31	25	2,31	25	1,37	25	1,23	25	8,28	25	1,52	25	0,84	25	0,86
1/2" - 16	25	2,46	25	2,46	25	1,28	25	1,55	25	9,18	25	1,73	25	0,95	25	0,92
1/2" - 18	25	2,64	25	2,64	25	1,65	25	1,42			25	1,94	25	0,92	25	0,98
1/2" - 22					25	1,77	25	1,86			25	2,33	25	0,98	25	1,55
3/4" - 14													25	1,46	25	1,70
3/4" - 15					25	1,97							25	1,52	25	1,58
3/4" - 16					25	1,89							25	1,68	25	1,65
3/4" - 18	25	3,75	25	3,75	25	1,95	25	1,58			25	2,64	25	1,53	25	1,40
3/4" - 22	25	3,97	25	3,97	25	2,28	25	2,43			10	3,57	25	1,44	25	1,53
3/4" - 28					10	3,23					10	5,41	10	2,37	10	2,49
1" x 18																0,00
1" - 22	25	5,06			25	3,65					10	4,82	25	2,33	25	2,28
1" - 28	10	6,98			10	5,40	10	3,89			10	6,43	10	2,43	10	2,46
1 1/4" - 35														4,27		5,92
1 1/4" - 42														5,15		7,10



MEDIDA	ENV.	PRECIO	ENV.	PRECIO	ENV.	PRECIO	ENV.	PRECIO	ENV.	PRECIO
3/8" - 10										
3/8" - 12	25	2,66	25	2,42	25	1,53	25	1,23		
3/8" - 14	25	2,66	25	2,39	25	1,55				
3/8" - 15	25	2,57	25	2,33	25	1,65				
1/2" - 10					25	1,83				
1/2" - 12	25	2,66	25	2,64	25	1,44	25	1,38	25	2,28
1/2" - 14	25	2,66	25	2,61	25	1,53			25	2,24
1/2" - 15	25	2,59	25	2,55	25	1,47	25	1,47	25	2,24
1/2" - 16	25	3,61	25	3,41	25	1,71	25	1,64	25	2,59
1/2" - 18	25	3,68	25	3,41	25	1,95	25	1,95	25	3,27
1/2" - 22	25	4,79				3,69				
3/4" - 14	25	3,97	25	3,83	25	2,59				
3/4" - 15	25	4,03	25	3,92	25	2,43	25	2,43		
3/4" - 16	25	3,06	25	3,74		2,66				
3/4" - 18	25	3,85	25	3,74	25	2,28	25	2,28		
3/4" - 22	25	5,59	25	5,84	25	2,59			10	4,31
3/4" - 28					25	5,23				
1" x 18					25	3,93				
1" - 22	25	6,41	25	6,68	10	3,75				
1" - 28	25	11,17	10	9,07	10	4,61			10	10,66
1 1/4" x 35	10	14,22	10	11,79	10	7,96				
1 1/2" x 42	10	23,43	10	20,95	10	10,42				

MEDIDA	ENV.	PRECIO
12 x 12	25	2,28
14 x 14	25	2,33
15 x 15	25	2,42
16 x 16	25	3,21
18 x 18	25	3,30
22 x 22	25	4,52
28 x 28	10	9,25
35 x 35	10	12,45
42 x 42	10	19,18
54 x 54	10	30,80

CODO 90° hembra-hembra

5090/90Cu



Ø	Código	€	UN
10	C0090010	1,78	10
12	C0090012	0,60	10
14	C0090014	0,78	10
15	C0090015	0,60	10
16	C0090016	0,95	10
18	C0090018	0,92	10
22	C0090022	1,51	10
28	C0090028	2,48	10
35	C0090035	10,08	10
42	C0090042	16,55	1

CODO 90° macho-hembra

5092/92Cu



Ø	Código	€	UN
10	C0092010	2,79	10
12	C0092012	1,34	10
14	C0092014	0,88	10
15	C0092015	0,66	10
16	C0092016	1,05	10
18	C0092018	1,45	10
22	C0092022	2,27	10
28	C0092028	4,01	10
35	C0092035	15,89	10
42	C0092042	22,55	1

CURVA 90° hembra-hembra

5002A/2aCu



Ø	Código	€	UN
10	C0072010	1,38	10
12	C0072012	0,60	10
14	C0072014	1,01	10
15	C0072015	0,84	10
16	C0072016	0,97	10
18	C0072018	1,21	10
22	C0072022	1,85	10
28	C0072028	2,99	10
35	C0072035	8,29	10
42	C0072042	11,45	1

CURVA 90° macho-hembra

5001A/1aCu



Ø	Código	€	UN
10	C0071010	3,16	10
12	C0071012	1,08	10
14	C0071014	0,99	10
15	C0071015	0,86	10
16	C0071016	1,05	10
18	C0071018	1,34	10
22	C0071022	1,85	10
28	C0071028	5,14	10
35	C0071035	15,12	10
42	C0071042	22,69	1

CURVA 45° hembra-hembra

5041/41Cu



Ø	Código	€	UN
10	C0081010	3,66	10
12	C0081012	2,29	10
14	C0081014	1,11	10
15	C0081015	0,78	10
16	C0081016	1,22	10
18	C0081018	1,60	10
22	C0081022	1,86	10
28	C0081028	3,36	10
35	C0081035	11,78	10
42	C0081042	20,73	1

CURVA 45° macho-hembra

5040/40Cu



Ø	Código	€	UN
10	C0080010	4,15	10
12	C0080012	1,56	10
14	C0080014	1,32	10
15	C0080015	0,71	10
16	C0080016	1,69	10
18	C0080018	1,67	10
22	C0080022	1,60	10
28	C0080028	3,44	10
35	C0080035	12,99	10
42	C0080042	22,63	1

CURVA (puente salvatubos) hembra-hembra

5085/85Cu



Ø	Código	€	UN
12	C0085012	8,29	10
14	C0085014	8,40	10
15	C0085015	4,04	10
16	C0085016	9,38	10
18	C0085018	10,88	10
22	C0085022	14,58	10

CURVA 180º hembra-hembra

5060/60Cu



Ø	Código	€	UN
12	C0083012	13,08	10
15	C0083015	9,14	10
16	C0083016	11,91	10
22	C0083022	16,11	10

CURVA de desviación (puente salvatubos) macho-hembra

5086/86Cu



Ø	Código	€	UN
12	C0086012	7,43	10
14	C0086014	7,63	10
15	C0086015	3,67	10
16	C0086016	8,58	10
18	C0086018	9,04	10
22	C0086022	12,65	10

TAPÓN hembra

5301/301Cu



Ø	Código	€	UN
10	C0301010	2,23	10
12	C0301012	1,81	10
14	C0301014	1,97	10
15	C0301015	0,93	10
16	C0301016	2,18	10
18	C0301018	1,15	10
22	C0301022	1,97	10
28	C0301028	3,74	10
35	C0301035	10,06	10
42	C0301042	17,77	1

TE IGUAL hembra

5130/130Cu



Ø	Código	€	UN
10	C0130010	2,69	10
12	C0130012	1,12	10
14	C0130014	1,11	10
15	C0130015	0,96	10
16	C0130016	1,27	10
18	C0130018	1,93	10
22	C0130022	2,86	10
28	C0130028	5,23	10
35	C0130035	15,18	10
42	C0130042	28,54	1

MANGUITO hembra-hembra

5270/270Cu



Ø	Código	€	UN
10	C0270010	0,45	10
12	C0270012	0,38	10
14	C0270014	0,42	10
15	C0270015	0,36	10
16	C0270016	0,48	10
18	C0270018	0,55	10
22	C0270022	0,88	10
28	C0270028	1,59	10
35	C0270035	3,95	10
42	C0270042	7,56	1

MANGUITO REDUCCIÓN
hembra-hembra

5240/240Cu



MANGUITO REDUCCIÓN
macho-hembra

5243



Ø	Código	€	UN
12-10	C0240130	2,12	10
14-10	C0240150	1,70	10
14-12	C0240152	1,00	10
15-12	C0240162	1,15	25
15-14	C0240164	1,32	10
16-12	C0240172	1,26	10
16-14	C0240174	1,00	10
16-15	C0240175	2,03	25
18-12	C0240192	2,77	10
18-14	C0240194	1,66	10
18-15	C0240195	0,96	25
18-16	C0240196	1,73	10
22-12	C0240232	6,08	10
22-14	C0240234	2,53	10
22-15	C0240235	2,64	25
22-16	C0240236	2,71	10
22-18	C0240238	1,79	10
28-15	C0240295	5,82	25
28-16	C0240296	6,55	10
28-18	C0240298	5,67	10
28-22	C0240302	2,79	10
35-18	C0240368	17,21	10
35-22	C0240372	11,26	10
35-28	C0240378	13,82	10
42-22	C0240442	24,37	1
42-28	C0240448	19,82	1
42-35	C0240455	15,52	1

Ø	Código	€	UN
12-10	C0242130	1,78	10
14-10	C0242150	1,42	10
14-12	C0242152	0,78	10
15-10	C0242160	1,96	25
15-12	C0242162	0,82	25
15-14	C0242164	1,81	10
16-12	C0242172	1,11	10
16-14	C0242174	0,82	10
16-15	C0242175	1,79	25
18-12	C0242192	2,04	10
18-14	C0242194	1,27	10
18-15	C0242195	0,71	25
18-16	C0242196	1,32	10
22-12	C0242232	4,71	10
22-14	C0242234	2,03	10
22-15	C0242235	1,29	25
22-16	C0242236	1,60	10
22-18	C0242238	1,32	10
28-12	C0242292	9,86	10
28-14	C0242294	6,38	10
28-15	C0242295	4,86	25
28-16	C0242296	6,53	10
28-18	C0242298	5,37	10
28-22	C0242302	2,23	10
35-15	C0242365	14,67	10
35-18	C0242368	11,62	10
35-22	C0242372	11,08	10
35-28	C0242378	7,36	10
42-15	C0242435	32,99	1
42-18	C0242438	35,24	1
42-22	C0242442	19,85	1
42-28	C0242448	15,67	1
42-35	C0242455	13,25	1

TE REDUCIDA hembra-hembra-hembra

5130R/130CuR



Ø	Código	€	UN
14-14-12	C0131243	3,00	10
12-15-12	C0131253	5,86	25
12-18-12	C0131273	9,70	10
14-12-12	C0131433	2,29	10
14-12-14	C0131434	1,58	10
14-16-14	C0131464	3,32	10
14-18-14	C0131474	4,34	10
15-12-12	C0131533	4,40	25
15-12-15	C0131535	2,16	25
15-15-12	C0131553	5,59	25
15-18-12	C0131573	13,36	25
15-22-15	C0131575	5,43	25
15-22-15	C0131595	11,48	10
16-12-16	C0131636	2,36	10
16-14-14	C0131644	2,36	10
16-14-16	C0131646	1,79	10
16-16-14	C0131664	2,63	10
16-22-16	C0131696	7,96	10
18-12-12	C0131833	10,15	10
18-12-15	C0131835	9,08	25
18-12-16	C0131836	5,67	10
18-12-18	C0131837	3,79	10
18-14-14	C0131844	4,49	10
18-14-16	C0131846	4,56	10
18-14-18	C0131847	2,33	10
18-15-12	C0131853	11,23	25
18-15-15	C0131855	2,64	25
18-15-18	C0131857	1,59	25
18-16-16	C0131866	4,77	10
18-16-18	C0131867	4,40	10
18-18-12	C0131873	12,25	10

Ø	Código	€	UN
18-18-15	C0131875	2,97	25
18-22-15	C0131895	10,07	25
18-22-18	C0131897	6,88	10
18-28-18	C0131907	20,70	10
22-12-12	C0132233	11,19	10
22-12-18	C0132237	12,58	10
22-12-22	C0132239	7,49	10
22-14-22	C0132249	3,75	10
22-15-15	C0132255	4,41	10
22-15-18	C0132257	4,89	25
22-15-22	C0132259	2,10	25
22-16-16	C0132266	6,73	10
22-16-18	C0132267	7,64	10
22-16-22	C0132269	3,93	10
22-18-15	C0132275	9,71	25
22-18-18	C0132277	5,23	10
22-18-22	C0132279	3,22	10
22-22-12	C0132293	12,58	10
22-22-15	C0132295	6,69	10
22-22-16	C0132296	7,44	10
22-22-18	C0132297	7,93	10
22-28-22	C0132299	13,45	10
22-35-22	C0132319	36,99	10
28-12-28	C0132840	15,54	10
28-14-28	C0132850	11,47	10
28-15-15	C0132855	17,21	10
28-15-18	C0132857	9,70	10
28-15-22	C0132859	12,49	10
28-15-28	C0132860	4,89	25
28-18-15	C0132875	19,59	10
28-18-18	C0132877	18,84	10

Ø	Código	€	UN
28-18-22	C0132879	13,38	10
28-18-28	C0132880	9,29	10
28-22-18	C0132897	19,25	10
28-22-22	C0132899	10,93	10
28-22-28	C0132900	5,89	10
28-28-15	C0132905	21,19	25
28-28-18	C0132907	18,32	10
28-28-22	C0132909	14,44	10
28-35-28	C0132920	27,81	10
35-15-35	C0133561	25,43	10
35-18-35	C0133581	26,29	10
35-22-22	C0133599	37,73	10
35-22-28	C0133600	23,48	10
35-22-35	C0133601	16,95	10
35-28-22	C0133609	35,36	10
35-28-28	C0133610	24,13	10
35-28-35	C0133615	24,18	10
35-35-22	C0133619	43,16	10
35-35-28	C0133620	40,78	10
42-15-42	C0134263	53,43	1
42-18-42	C0134283	56,98	1
42-22-35	C0134301	36,81	1
42-22-42	C0134303	37,37	1
42-28-35	C0134311	34,77	1
42-28-42	C0134313	41,25	1
42-35-35	C0134321	66,21	1
42-35-42	C0134323	51,13	1

ACCESORIOS DE LATON DE COMPRESION

TUBO COBRE

ART. 200

MANGUITO MACHO



MEDIDA	UN	PRECIO
12 x 3/8"	10	1,67 €
12 x 1/2"	10	1,75 €
15 x 1/2"	10	1,51 €
18 x 1/2"	10	2,02 €
18 x 3/4"	10	2,69 €
22 x 1/2"	10	2,91 €
22 x 3/4"	10	2,68 €
22 x 1"	10	3,33 €
28 x 3/4"	10	4,95 €
28 x 1"	10	5,42 €

ART. 201

MANGUITO DOBLE



MEDIDA	UN	PRECIO
12 x 12	10	1,51 €
15 x 15	10	2,05 €
18 x 18	10	3,01 €
22 x 22	10	3,35 €
28 x 28	10	5,93 €

ART. 202

MANGUITO HEMBRA



MEDIDA	UN	PRECIO
12 x 3/8"	10	1,36 €
12 x 1/2"	10	1,72 €
15 x 1/2"	10	1,65 €
18 x 1/2"	10	2,20 €
18 x 3/4"	10	3,04 €
22 x 1/2"	10	2,96 €
22 x 3/4"	10	2,68 €
22 x 1"	10	4,12 €
28 x 1"	10	5,14 €

ART. 203

CODO DOBLE



MEDIDA	UN	PRECIO
12 x 12	10	1,51 €
15 x 15	10	2,05 €
18 x 18	10	3,01 €
22 x 22	10	3,35 €
28 x 28	10	5,93 €

ART. 204

CODO MACHO



MEDIDA	UN	PRECIO
15 x 1/2"	25	2,16 €
18 x 1/2"	10	2,83 €
18 x 3/4"	10	3,91 €
22 x 3/4"	10	3,89 €

ART. 205

CODO HEMBRA



MEDIDA	UN	PRECIO
12 x 1/2"	10	2,45 €
15 x 3/8"	10	2,61 €
15 x 1/2"	10	2,09 €
18 x 1/2"	10	2,60 €
18 x 3/4"	10	4,11 €
22 x 1/2"	10	3,54 €
22 x 3/4"	10	3,91 €

ART. 206

CODO PLACA HEMBRA



MEDIDA	UN	PRECIO
15 x 1/2"	10	3,13 €
18 x 1/2"	10	4,79 €

ART. 207

TE INTERMEDIA



MEDIDA	UN	PRECIO
12 x 12	10	2,53 €
15 x 15	10	2,97 €
18 x 18	10	4,00 €
22 x 22	10	5,69 €
28 x 28	10	10,17 €

ART. 209

TE HEMBRA



MEDIDA	UN	PRECIO
15 x 1/2"	10	2,45 €
18 x 1/2"	10	4,56 €
18 x 3/4"	10	5,48 €
22 x 1/2"	10	5,08 €
22 x 3/4"	10	5,75 €
28 x 3/4"	10	8,35 €

ART. 235

TAPON



MEDIDA	UN	PRECIO
15	10	1,24 €
18	10	2,24 €
22	10	3,53 €
28	10	3,85 €

ART. 215

ANILLO LATON



MEDIDA	UN	PRECIO
12	100	0,21 €
15	100	0,23 €
18	100	0,27 €
22	150	0,29 €
28	125	0,40 €

Tectite
SPRINT



WRAS
APPROVED
PRODUCT

Racores instantáneos No desmontables

para agua sanitaria y calefacción



Ventajas

- Montaje muy rápido y sencillo.
- Se puede utilizar para tubería de cobre, PE-X y PB.
- Limpio y sin herramientas.
- La unión realizada permite girar 360°.
- Sin soplete.
- No hay peligro de quemaduras o incendio.
- Aplicable donde la soldadura no es posible.
- Permite unir incluso con la tubería mojada.

Aspectos técnicos

- Fabricado en Cobre o bronce DZR.
- Anillo de sujeción de Acero Inoxidable ha sido desarrollado especialmente para sujetar perfectamente el tubo.
- Anillo de protección de Nylon.
- Junta tórica de EPDM lubricada para su fácil inserción y apta para el agua potable fría y caliente. Fabricada bajo las normas: WRAS, DVGW W270 y KTW categorías D1 y D2: Test de Higiene para partes no metálicas aplicable a juntas tóricas.
- Los accesorios con extremos roscados, tanto macho como hembra están provistos con una rosca conforme a BS EN ISO 228:2003.

IMPORTANTE: Los productos Tectite no son aptos para su uso con Gas.

CONSEJO

Los accesorios Tectite no deberán entrar en contacto con productos de limpieza, pinturas, grasas, decapantes, aceites minerales, adhesivos u otros disolventes que podrían dañar la junta tórica durante la instalación. Estos accesorios no deberían ser pintados.

Instrucciones para el montaje y desmontaje

El principio de los manguitos de presión Tectite es genial por su sencillez y además son muy prácticos en el uso.



Figura 1
Cortar el tubo.



Figura 2
Desbarbar y calibrar el tubo.



Figura 3
Marcar la profundidad de inserción.



Figura 4
Comprobar la limpieza de la pieza.



Figura 5
Insertar el tubo en la pieza hasta oír "click".

Aplicaciones

En instalaciones canalizadas de agua caliente y fría, agua sanitaria, calefacción, calefacción central y climatización, aire comprimido libre de aceites (máx. 16 bar). Refrigeración con adiciones de glicol.

No son aptos para aceites minerales, gases ni sustancias que contengan grasa.

Al estar fabricado en cobre de alta calidad y bronce DZR, aporta una resistencia mecánica extraordinaria siendo el nuevo Tectite SPRINT compatible para su utilización con los diferentes tubos que a continuación detallamos:

- Tubería de cobre según Normativa EN 1057.
- Tubería PE-X según BS 7291: Parte 3.
- Tubería de Polibutileno según BS 7291: Parte 2, que incluimos en nuestro sistema de PB (Polyplumb) y que garantizamos plenamente.

Advertencia: En el caso de que se aplique un tubo de plástico normalizado, deben utilizarse los insertos o casquillo del proveedor del tubo.

Temperatura y presión de servicio

Tectite SPRINT utilizado con tubería de Cobre				
Temperatura de Servicio	Min.	30°C	65°C	Máx.
Medidas 15-28mm	20 bar	20 bar	16 bar	10 bar

Tectite SPRINT utilizado con tubería de Pe-x y PB				
Temperatura de Servicio	Min.	20°C	65°C	Máx.
Medidas 15-28mm	12 bar	12 bar	6 bar	3 bar

Profundidad

A continuación indicamos en la tabla las longitudes de introducción de las diferentes medidas para su marcaje:

Tamaño accesorio	Profundidad inserción
15 mm	Aprox. 16 mm
18 mm	Aprox. 17 mm
22 mm	Aprox. 18 mm
28 mm	Aprox. 20 mm

CODO 90° hembra

TT12/TT090



Ø	Cod.	€	UN
12	F82134	4,85	10
15	F82031	4,09	10
18	F82137	7,23	5
22	F82032	9,46	5
28	F82033	19,21	5

CODO 45° hembra

TT21/TT041



Ø	Cod.	€	UN
12	F82143	3,75	10
15	F82145	4,09	10
18	F82147	5,45	5
22	F82148	9,06	5
28	F82149	18,41	5

05/03/2020



CODO 90° ROSCADO macho

TT13/TT092G



Ø	Cod.	€	UN
15 x 1/2"	F82040	9,11	10

CODO 90° ROSCADO hembra

TT14/TT090G



Ø	Cod.	€	UN
15 x 1/2"	F82045	7,42	10

CODO 90° ROSCADO TUERCA LOCA hembra

TT63/TT063



Ø	Cod.	€	UN
12 x 1/2"	F82106	17,23	10
15 x 1/2"	F82105	14,11	10
18 x 1/2"	F82107	18,78	5

CODO 90° PLACA ROSCADO hembra

TT15/TT471G



Ø	Cod.	€	UN
12 x 1/2"	F82048	12,92	5
15 x 1/2"	F82050	10,64	5

MANGUITO ROSCADO TUERCA LOCA hembra

TT62/TT062



Ø	Cod.	€	UN
12 x 3/8"	F82109	12,97	10
12 x 1/2"	F82110	12,51	10
15 x 1/2"	F82101	12,36	10
18 x 1/2"	F82115	14,49	5
18 x 3/4"	F82116	17,24	5
22 x 3/4"	F82103	20,89	5

MANGUITO ROSCADO hembra

TT2/TT270G



Ø	Cod.	€	UN
12 x 1/2"	F82007	8,15	10
15 x 1/2"	F82010	6,74	10
18 x 1/2"	F82013	9,11	5
22 x 3/4"	F82011	11,14	5

MANGUITO ROSCADO macho

TT3/TT243G



Ø	Cod.	€	UN
12 x 3/8"	F82119	5,30	10
12 x 1/2"	F82101	6,11	10
15 x 1/2"	F82015	7,39	10
18 x 3/4"	F82124	9,76	5
22 x 3/4"	F82016	11,11	5
28 x 1"	F82018	16,16	2

MANGUITO UNIÓN hembra

TT1/TT270



Ø	Cod.	€	UN
12	F82170	3,90	10
15	F82001	3,17	10
18	F82173	6,88	5
22	F82002	8,36	5
28	F82003	13,94	5

MANGUITO REDUCCIÓN macho-hembra

TT6/TT243



Ø	Cod.	€	UN
15 x 12	F82024	5,45	10
18 x 15	F82028	11,11	10
22 x 15	F82025	5,06	10
28 x 15	F82026	7,42	5
28 x 22	F82027	10,73	5

MANGUITO REDUCCIÓN hembra

TT1R/TT240



Ø	Cod.	€	UN
15 x 12	F82126	5,06	10
18 x 15	F82129	9,58	5
22 x 15	F82005	16,85	5
22 x 18	F82132	17,87	5

TE IGUAL hembra

TT24/TT130



Ø	Cod.	€	UN
12	F82051	6,26	10
15	F82056	5,12	10
18	F82054	11,34	5
22	F82057	13,15	5
28	F82058	24,61	2

TE REDUCIDA hembra

TT25/TT130R



Ø	Cod.	€	UN
15x12x15	F82158	9,97	10
15x15x12	F82070	15,10	10
18x12x18	F82161	17,88	5
18x18x12	F82071	19,30	5
18x15x18	F82163	17,86	5
22x15x22	F82068	12,79	5
22x22x15	F82073	14,84	5
28x15x28	F82068	24,61	2
28x28x15	F82075	22,26	2
28x22x28	F82069	26,60	2
28x28x22	F82075	23,59	2
22x15x15	F82082	10,11	5
28x22x22	F82084	25,42	2

MANGUITO conexión a tanque hembra-rosca macho

TT5



Ø	Cod.	€	UN
15 x 1/2"	F82020	11,11	5
22 x 3/4"	F82021	16,58	5

TAPÓN ROSCADO hembra

TT61/TT301



Ø	Cod.	€	UN
12	F82094	2,79	10
15	F82091	3,44	10
18	F82097	5,30	5
22	F82092	6,42	5
28	F82093	12,13	5



L'ISOLANTE K-FLEX

- Desperdicio de producto
- Espacio de stock
- + Flexible y robusto

λ 40 °C = 0,040 W/(m·K)

μ > 3000

DIN 4102 B1 (D)

CL. 1 (I)

M1-NF (F)

M1 (E)

- Nueva presentación del producto
- Óptima aplicación en las instalaciones
- Desarrollado especialmente para el sector termosanitario y calefacción



MEDIDA		
ESPESOR	Ø	Metros
13	12	30
	15	26
	18	25
	22	21
	28	15

PRECIO
30,81 €



COLORES: AZUL Y ROJO

PARA DIFERENCIAR DE LOS DE PROTECCION ELECTRICA

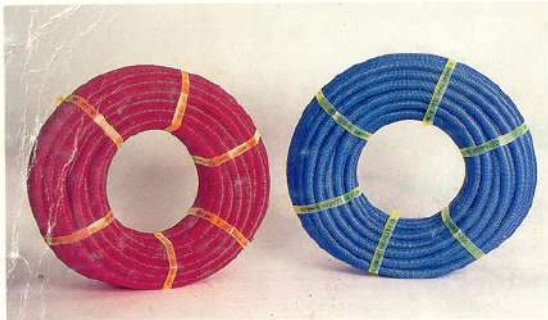

MATERIAL: POLIPROPILENO (material que no contiene productos que puedan dañar al cobre, hierro, polietileno reticulado, etc.).

PROPIEDADES: Resiste temperaturas de 100° C. superiores a las de PVC (60° C). Protege MECANICAMENTE y contra los AGENTES EXTERNOS como yeso, cemento, cal, etc. a las tuberías de cobre, hierro, polietileno reticulado, etc.

APLICACIONES: SEÑALIZACION y PROTECCION de conducciones de agua caliente (Rojo) y fría (Azul) de los tubos de cobre, hierro, polietileno, etc., en instalaciones sanitarias, adaptándose a cualquier instalación de suministros de agua.

TIPO		11	13,5	16	19	23	29	36
Ø mm.	EXTERIOR	15,8	18,7	21,2	24,0	28,5	34,5	42,5
	INTERIOR	11,3	14,3	16,6	19,0	23,3	29	36,6
ROLLO (m)		50	50	50	50	50	25	25
Ø TUBERIA	COBRE mm.	10	12	15	18	22	28	35
	ACERO AL CARBONO		1/8"	1/4"	3/8"	1/2"		

TIPO	MEDIDA						
	11	13,5	16	19	23	29	36
FONTANERIA AZUL Y ROJO		0,31	0,27	0,34	0,46	0,66	1,05
ELECTRICO ATUPLAST	0,17	0,22	0,27		0,43	0,55	0,83
ELECTRICO FORPLAST	0,29	0,36	0,43		0,63	0,88	1,63

Suministros
FONTANA. S.L.

No 102

K-FLEX SOLAR

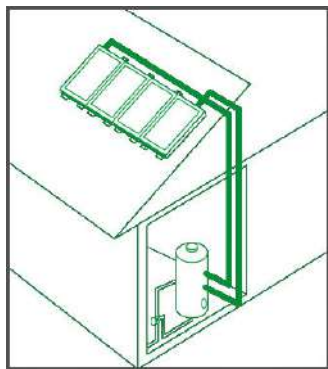

**LA SOLUCION RACIONAL Y CONVENIENTE PARA
PANELES SOLARES Y PROCESOS
INDUSTRIALES HASTA 150 °C**

K-FLEX SOLAR viene en tubos/rollos de 25 metros y en
Tubos lineales de 2 metros de longitud



Revolucionario y
exclusivo embalaje
que mejora el
concepto de servicio
al cliente ofreciendo
indudables ventajas,
practicidad y
economía en la
distribución y el uso.
Dimensiones caja:
395 x 580 x 580 mm



K-FLEX SOLAR tubo en rollo (CAJAS de 25 metros)

K-FLEX SOLAR tubo lineal (2 metros)

Ø Tubo mm	Espesor mm	PRECIO €/ metro	METROS CAJA
18	19	7,48 €	58
22	19	7,81 €	64
28	19	9,04 €	48
35	19	9,92 €	36

**DESCUENTO
POR CAJA
10%**

Ø Tubo mm	Espesor mm	PRECIO €/ metro
18	19	7,25 €
22	19	7,83 €

K-FLEX SOLAR EXTERIOR PROTECCION UV tubo lineal (2 metros)

Ø Tubo mm	Espesor mm	PRECIO €/ metro	METROS CAJA
18	20	8,45 €	58
22	20	9,10 €	50
28	20	10,27 €	40
35	20	10,61 €	32

Negro o Blanco



Reglamento de instalaciones térmicas en los Edificios (RITE)
Espesores según instrucciones técnicas complementarias ITE 03.12 (Apéndice 03.1)

DATOS TÉCNICOS

Límite de temperatura de uso	+150 °C*
Conductibilidad térmica λ W/(m·K) ENISO 8497 (DIN 52613) - EN 12667 (DIN 52612)	+20 °C = 0,040 / 40 °C = 0,042 / +60 °C = 0,045
Problemática de corrosión	DIN 1988/7; pH neutro
Resistencia al fuego	Cl. 1 BS 476 Part 7 (UK) - B2 DIN 4102 (D) Brandkennziffer 5-3 (CH)
Datos ecológicos	No CFC, HCFC - No formaldehído

TUBO AISLANTE DE POLIETILENO "PE"

Interno mm	6 mm		10 mm	
	m/caja	PRECIO	m/caja	PRECIO
12	560	0,35 €	400	0,66 €
15	480	0,36 €	400	0,66 €
18	460	0,41 €	300	0,67 €
22	350	0,58 €	270	0,77 €
28	280	0,58 €	196	1,25 €
35	180	0,73 €	160	1,02 €
42	140	0,89 €	110	1,36 €

TUBO AISLANTE DE POLIMERO "EC"

Interno mm	9 mm		19 mm	
	m/caja	PRECIO	m/caja	PRECIO
12	234	0,91 €	64	3,17 €
15	192	1,00 €	60	3,33 €
18	166	1,25 €	60	3,66 €
22	136	1,27 €	50	3,67 €
28	98	1,52 €	40	4,43 €
35	76	1,86 €	32	5,26 €
42	60	2,39 €	32	6,27 €
48	50	2,81 €	24	7,69 €

K-FLEX TWIN SOLAR SYSTEM - ACCESORIOS

Código	Kit para la instalación	PRECIO
850VR020316	Kit accesorios TWIN SOLAR SYSTEM DN16 compuesto por 4 juntas, 4 tuercas y 4 arandelas	13,31
850VR020317	Kit accesorios TWIN SOLAR SYSTEM DN20 compuesto por 4 juntas, 4 tuercas y 4 arandelas	18,46
850VR020304	Macho doble rosca 3/4" para sistema TWIN SOLAR SYSTEM (tubos Ø ext, DN16)	10,33
850VR020305	Macho doble rosca para sistema TWIN SOLAR SYSTEM (tubos Ø ext, DN20)	17,31



Herramientas para el montaje

- 1- macho doble rosca
- 2- tuerca
- 3- arandela
- 4- junta

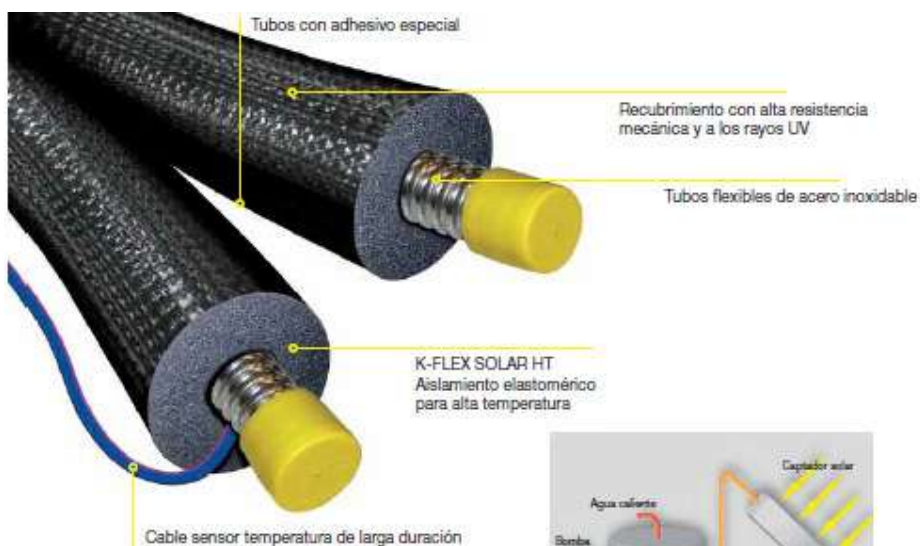

DATOS TÉCNICOS CABLE SENSOR TEMPERATURA

Rango de temperaturas	De -60 °C a +200 °C
Cobre flexibles Ø 1 mm	CEI 20 - 19/15
Aislamiento del cable	Goma de silicona
Tensión nominal	300/500 V
Resistencia eléctrica	20.0 Ohm/km

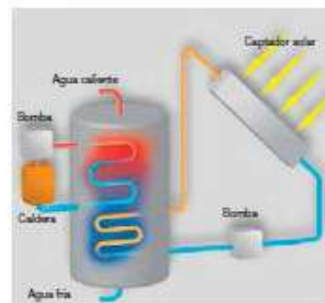

K-FLEX se reserva el derecho de cambiar cualquier dato o característica sin previo aviso.

K-FLEX TWIN SOLAR SYSTEM CONSEJOS PARA LA INSTALACIÓN



Tubo de acero			Espesor del aislante K-FLEX SOLAR: 20 mm			
diámetro ext. en mm.	diámetro int. DN	Espesor de la pared en mm	producto	Largo del rollo	Cont. caja	PRECIO € / ml
21,4	16	0,18	86TW0S2002201	10 m	10 m	45,00
21,4	16	0,18	86TW0S2002202	15 m	15 m	43,38
21,4	16	0,18	86TW0S2002203	20 m	20 m	42,74
21,4	16	0,18	86TW0S2002204	25 m	25 m	42,02
26,7	20	0,20	86TW0S2002801	10 m	10 m	51,68
26,7	20	0,20	86TW0S2002802	15 m	15 m	50,97
26,7	20	0,20	86TW0S2002803	20 m	20 m	49,98
26,7	20	0,20	86TW0S2002804	25 m	25 m	49,18

Valvulas y detentores de radiador

VALVULA Y DETENTOR DE ROSCAR



CODIGO	MEDIDA	UN	PRECIO
01901	3/8"	12	8,42 €
01905	1/2"	12	9,58 €



CODIGO	MEDIDA	UN	PRECIO
01951	3/8"	12	6,40 €
01955	1/2"	12	7,64 €

VALVULA Y DETENTOR POKER para tubo de cobre, multicapa y reticulado



CODIGO	MEDIDA	UN	PRECIO
0392019429	3/8"	12	7,64 €
0392019443	1/2"	12	8,79 €



CODIGO	MEDIDA	UN	PRECIO
0392020623	3/8"	12	7,33 €
0392020647	1/2"	12	6,99 €

VALVULA POKER para tubo de cobre, multicapa y reticulado

Termostatizable



CODIGO	MEDIDA	UN	PRECIO
0392018347	3/8"	12	10,20 €
0392018354	1/2"	12	10,94 €

Cabezal con mando y sensor incorporado para instalaciones standard



CODIGO	UN	PRECIO
0392018460	6	13,16 €



REVERSIBLES

Con cierre total para vacio de radiador.

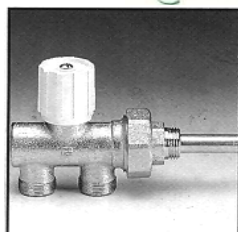

CODIGO	Medida	PRECIO
0457015791	1/2"	27,68 €

Termostatizable

CODIGO	Medida	€
1439-12	1/2"	41,06 €

Cabezal con mando y sensor incorporado para valvulas monotubo



Cabezal termostático de cápsula líquida para valvulas, con sensor incorporado. Regulación de Ta: 0 a 28°C (escala numerada de 1 a 5)

CODIGO	UN	PRECIO
1013076	6	13,44 €

Rosca Ø 24 x 19

LLAVES RADIADOR TOALLERO

S418C

Juego válvula y detentor Sphere
Rosca 3/4" eurocono

CODIGO	MEDIDA	COLOR	PRECIO
C84100	1/2" - 3/4"	CROMO	80,00 €



S418W

Juego válvula y detentor Sphere
Color Blanco RAL 9016
Rosca 3/4" eurocono

CODIGO	MEDIDA	COLOR	PRECIO
C84101	1/2" - 3/4"	BLANCO	71,52 €



**PARA 50 JUEGOS
5% DE DESCUENTO**

Nº 106

Tapones y reducciones para radiador

Diámetro 42 mm CINCADOS. Para radiadores de aluminio.



**PRECIO ESPECIAL
POR CANTIDAD!
SIRVANSE CONSULTAR**



REFERENCIA	Ø	TIPO	MEDIDA	GIRO	ENVASE	PRECIO
15101D	42	Ciego	1"	Derecha	200	0,81 €
15101I	42	Ciego	1"	Izquierda	200	0,81 €
15318D	42	Reducido	1 x 1/8"	Derecha	200	0,88 €
15318I	42	Reducido	1 x 1/8"	Izquierda	200	0,88 €
15338D	42	Reducido	1 x 3/8"	Derecha	200	0,88 €
15338I	42	Reducido	1 x 3/8"	Izquierda	200	0,88 €
15312D	42	Reducido	1" x 1/2"	Derecha	200	0,88 €
15312I	42	Reducido	1" x 1/2"	Izquierda	200	0,88 €
15334D	42	Reducido	1 " x 3/4"	Derecha	200	0,88 €
15334I	42	Reducido	1 " x 3/4"	Izquierda	200	0,88 €

Diámetro 42 mm BARNIZADOS BLANCO RAL 9010. Para radiadores de aluminio.



**PRECIO ESPECIAL
POR CANTIDAD!
SIRVANSE CONSULTAR**



REFERENCIA	Ø	TIPO	MEDIDA	GIRO	ENVASE	PRECIO
15701D	42	Ciego	1"	Derecha	40	1,04 €
15701I	42	Ciego	1"	Izquierda	40	1,04 €
15828D	42	Reducido	1 x 1/8"	Derecha	40	1,10 €
15818I	42	Reducido	1 x 1/8"	Izquierda	40	1,10 €
15838D	42	Reducido	1 x 3/8"	Derecha	40	1,10 €
15838I	42	Reducido	1 x 3/8"	Izquierda	40	1,10 €
15812D	42	Reducido	1" x 1/2"	Derecha	40	1,10 €
15812I	42	Reducido	1" x 1/2"	Izquierda	40	1,10 €

Diámetro 48 mm CINCADOS. Para radiadores de aluminio, hierro fundido y acero.



REFERENCIA	Ø	TIPO	MEDIDA	GIRO	ENVASE	PRECIO
16501D	48	Ciego	1"	Derecha	200	0,93 €
16501I	48	Ciego	1"	Izquierda	200	0,93 €
16618D	48	Reducido	1 x 1/8"	Derecha	200	1,06 €
16618I	48	Reducido	1 x 1/8"	Izquierda	200	1,06 €
16638D	48	Reducido	1 x 3/8"	Derecha	200	1,02 €
16638I	48	Reducido	1 x 3/8"	Izquierda	200	1,02 €
16612D	48	Reducido	1" x 1/2"	Derecha	200	1,02 €
16612I	48	Reducido	1" x 1/2"	Izquierda	200	1,02 €



Características técnicas del radiador convector

RESULTADOS DE LOS ENSAYOS EFECTUADOS SEGUN NORMA EN-442

Radiador en aleación de aluminio

Presión de servicio: 6 bar

MODELO	Altura total m / m	Distancia ejes m / m	Anchura frontal m / m	Profundidad lateral m / m	Capacidad de agua litros	Peso en Kg.	Ø de conexión.	Exponente n=	Emisión con Δt=50°K según norma EN442		PRECIO €
									W	Kcal/h	
RD / 350	340	260	80	96	0,326	0,923	1"	1,30	72	62,21	15,88
RD / 600	580	500	80	96	0,51	1,48	1"	1,33	126	108,86	14,10
RD / 700	680	600	80	96	0,572	1,689	1"	1,34	145	125,56	20,59

Para hallar correctamente los diversos factores de corrección para Δt 50 K debe utilizarse la fórmula siguiente:

$$P_{\Delta t} = P_{50} \left(\frac{\Delta t}{50 K} \right)^n$$

$P_{\Delta t}$ = potencia térmica
 P_{50} = potencia térmica a Δt=50K
 n = exponente

Conociendo el valor de n (que figura en la tabla de medidas) creemos que no es necesario extenderse en cómo hallar dicho valor. De todas formas en el cuadro que figura a continuación, detallamos incluso las potencias a diferentes Δt para no tener que utilizar ninguna fórmula.

$$\Delta t \text{ en K} = \left(\frac{\text{temperatura de entrada del agua} + \text{temperatura de salida}}{2} \right) - \text{la temperatura ambiente}$$

FACTORES DE CORRECCION PARA LOS MODELOS RAYCO RD/600 EXP. 1,33

Δt	-	1 K	2 K	3 K	4 K	5 K	6 K	7 K	8 K	9 K
20 K	0,296	0,315	0,336	0,356	0,377	0,398	0,419	0,441	0,462	0,485
30 K	0,507	0,530	0,552	0,575	0,599	0,622	0,646	0,670	0,694	0,719
40 K	0,743	0,768	0,793	0,818	0,844	0,869	0,895	0,921	0,947	0,973
50 K	1,000	1,027	1,054	1,081	1,108	1,135	1,163	1,190	1,218	1,246
60 K	1,274	1,303	1,331	1,360	1,389	1,418	1,447	1,476	1,505	1,535
70 K	1,564	1,594	1,624	1,654	1,684	1,715	1,745	1,776	1,807	1,837

EJEMPLO PRACTICOS:

Temperatura de entrada del agua = 79° C
 Temperatura de salida del agua = 66° C
 Grados a elevar el ambiente = 20,5° C

$$\Delta t = \left(\frac{79^{\circ}\text{C} + 66^{\circ}\text{C}}{2} \right) - 20,5^{\circ}\text{C} = 52 \text{ K}$$

FACTOR DE CORRECCION A 52 K = 1,054
 Emisión de un elemento RAYCO RD/600 en dichas condiciones = 126 x 0,864 x 1,054 = 114,742 Kcal/h



SUMINISTRO: Los elementos de radiador del modelo RAYCO RD se suministran pintados con una primera capa de anaforesis y posteriormente con polvo exposi poliester de color blanco, formando baterías de 2 hasta 12 elementos. Estas baterías van protegidas con cantoneras de poliestireno expandido y recubiertas de una funda de plástico retractil que aparte de protegerlas durante el transporte, permite dejarlas instaladas con dicha protección hasta el fin de la obra.

INSTRUCCIONES DE USO Y MONTAJE:

El radiador RAYCO-RD puede ser utilizado en instalaciones con agua caliente o sobrecalentada hasta una temperatura máxima de 120° C.

La presión máxima de funcionamiento es de 6 bar (600 kPa). Deben ser instalados a una distancia mínima del suelo de 12 cm.

De entre 3 y 5 cm. de la pared posterior y 10 cm. del borde superior de la hornacina o de un cubre-radiador.

Es conveniente utilizar purgadores de tipo automático. De utilizar otro tipo de purgadores, NO CERRAR NUNCA LOS RETORNOS (Detenores) puesto que puede crear sobrepresión en la cámara de agua del radiador.

Con la válvula monotubular de cuatro vías manual, no cerrar totalmente el radiador para liberar la posible sobrepresión.

La válvula con cabeza termostática, si se cierra totalmente, si deja libre el retorno para liberar la posible sobrepresión.

Oferta RD/600

MINIMO ELEMENTOS	PRECIO ELEMENTO
150	12,96 €



MODELO
RD

Nº 108 02

Una Obra bien acabada

Características técnicas del radiador convector

RESULTADOS DE LOS ENSAYOS EFECTUADOS SEGUN NORMA EN-442

Radiador en aleación de aluminio inyectado.

Presión de servicio: 6 bar

MODELOS	Altura total m/m	Distancia esp m/m	Anchura frontal m/m	Profundidad lateral m/m	Capacidad de agua en litros	Peso en Kg.	Ø de conexión	Exponente n=	Emisión con Δt=50° K según norma EN 442	
									W	Kcal/h.
/ 350	340	260	80	96	0,326	0,923	1"	1,30	72	62,21
/ 600	580	500	80	96	0,510	1,48	1"	1,33	126	108,86
/ 700	680	600	80	96	0,572	1,689	1"	1,34	146	125,56

Para hallar correctamente los diversos factores de corrección para Δt 50 K debe utilizarse la fórmula siguiente:

$$P_n = P_{50} \left(\frac{\Delta t}{50 \text{ K}} \right)^n$$

P_n = potencia térmica

P_{50} = potencia térmica a Δt=50 K

n = exponente

Conociendo el valor de n (que figura en la tabla de medidas) creemos que no es necesario extenderse en cómo hallar dicho valor. De todas formas en el cuadro que figura a continuación, detallamos incluso las potencias a diferentes Δt para no tener que utilizar ninguna fórmula.

$$\Delta t \text{ en K} = \left(\frac{\text{temperatura de entrada del agua} + \text{temperatura de salida}}{2} \right) - \text{la temperatura ambiente}$$

FACTORES DE CORRECCION PARA LOS MODELOS RAYCO RD/600 EXP. 1,33

Δt	-	1°C	2°C	3°C	4°C	5°C	6°C	7°C	8°C	9°C
20 K	0,296	0,315	0,336	0,356	0,377	0,398	0,419	0,441	0,462	0,485
30 K	0,507	0,530	0,552	0,575	0,599	0,622	0,646	0,670	0,694	0,719
40 K	0,743	0,768	0,793	0,818	0,844	0,869	0,895	0,921	0,947	0,973
50 K	1,000	1,027	1,054	1,081	1,108	1,135	1,163	1,190	1,218	1,246
60 K	1,274	1,303	1,331	1,360	1,389	1,418	1,447	1,476	1,505	1,535
70 K	1,564	1,594	1,624	1,654	1,684	1,715	1,745	1,776	1,807	1,837

SUMINISTRO: Los elementos de radiador del modelo RD se suministran pintados con una primera capa de anaforesis y posteriormente con polvo epoxi poliéster de color blanco, formando baterías de 2 hasta 12 elementos. Estas baterías van protegidas con cantoneras de poliestireno expandido y recubiertas de una funda de plástico retráctil que aparte de protegerlas durante el transporte, permite dejarlas instaladas con dicha protección hasta el final de la obra.

INSTRUCCIONES DE USO Y MONTAJE:

El radiador RAYCO-RD puede ser utilizado en instalaciones con agua caliente o sobrecalentada hasta una temperatura máxima de 120° C.

La presión máxima de funcionamiento es de 6 bar (600 kPa). Deben ser instalados a una distancia mínima del suelo de 12 cm.

De entre 3 y 5 cm. de la pared posterior y de 10 cm. del borde superior de la hornacina o de un cubre-radiador.

Es conveniente utilizar purgadores de tipo automático. De utilizar otro tipo de purgadores, NO CERRAR NUNCA LOS RETORNOS (Detentores) puesto que puede crear sobrepresión en la cámara de agua del radiador.

Con la válvula monotubular de cuatro vías manual, no cerrar totalmente el radiador para liberar la posible sobrepresión.

La válvula con cabeza termostática, si se cierra totalmente, si deja libre el retorno para liberar la posible sobrepresión.

La utilización de juntas de teflón y de plástico labiales para empalmar o taponar los radiadores, nos exime de cualquier responsabilidad ante cualquier tipo de reclamación.

EJEMPLOS PRACTICOS:

Temperatura de entrada del agua = 79° C

Temperatura de salida del agua = 66° C

Grados a elevar en el ambiente = -20,5° C

$$\Delta t = \left(\frac{79^{\circ}\text{C} + 66^{\circ}\text{C}}{2} \right) - 20,5^{\circ}\text{C} = 52 \text{ K}$$

FACTOR DE CORRECCION A 52 K = 1,054

Emisión de un elemento RAYCO RD/600 en dichas condiciones = 126 x 0,864 x 1,054 = 114,742 Kcal/h.



Radiadores Toalleros

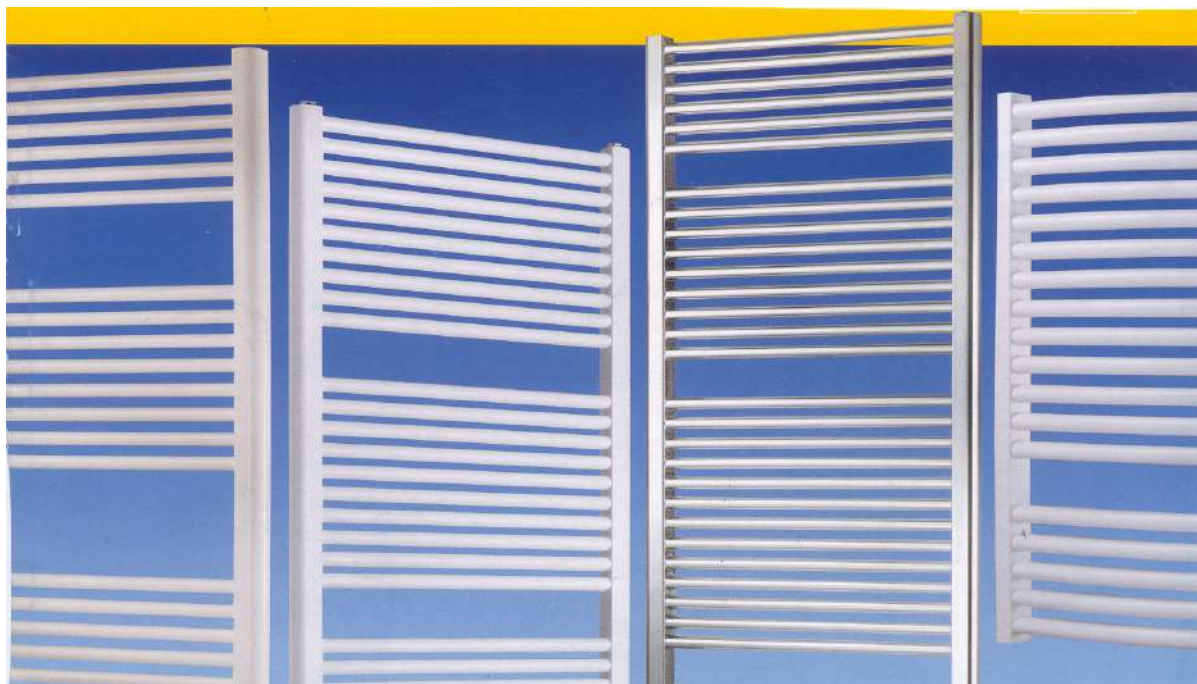

Medidas (mm)			Nº Tubos	Color	Potencia	PRECIO
Alto	Ancho	Entre Eje			DT.50W	
818	530	500	15	Blanco	384	82,50 €
1118	480	450	22	Blanco	508	114,83 €
1118	530	500	22	Blanco	553	120,38 €
1462	480	450	28	Blanco	652	141,67 €
1462	530	500	28	Blanco	711	148,33 €
1720	530	500	34	Blanco	860	183,33 €

818	480	450	15	Cromo	231	205,70 €
1118	480	450	22	Cromo	334	250,50 €
1462	480	450	28	Cromo	426	282,95 €
1462	530	500	28	Cromo	466	295,83 €

Radiador toallero *ELECTRICO ARES* con electrónica

Medidas (mm)			Nº Tubos	Color	Potencia	PRECIO
Alto	Ancho	Entre Eje			W	
818	480	450	15	Blanco	400	160,00 €
1118	480	450	22	Blanco	600	204,00 €
1462	480	450	28	Blanco	800	246,00 €
1720	480	450	34	Blanco	1000	279,00 €

818	480	450	15	Cromo	250	334,00 €
1118	480	450	22	Cromo	400	375,00 €
1462	480	450	28	Cromo	500	419,00 €
1720	480	450	34	Cromo	600	461,00 €



Resistencia C/Interruptor 400W	92,03 €
Resistencia C/Interruptor 600W	97,47 €
Resistencia conex. Rapida 400W	69,43 €
Resistencia conex. Rapida 600W	74,68 €
Termostato Analógico Blanco	86,47 €
Termostato Analógico Cromo	97,38 €

Radiador-convector eléctrico de bajo consumo sin fluidos.



Modelo ONE CRT

Regulación y Control de temperatura y tiempos mediante el

NUEVO Crono-Termostato Electrónico Digital.

¡NUEVA! Pantalla LCD retro-iluminada.

¡NUEVA! Programación. Más sencilla e intuitiva



Resistencias blindadas en
acero inoxidable en cada elemento.

CSR

Compuesto Sólido Refractario.
Compuesto de alto contenido mineral
para una mejor disipación del calor.

10 años de garantía total en el radiador,
componentes internos y componentes de
transmisión. 2 años de garantía en todos los
componentes electrónicos.

Al compararlos con otros emisores rellenos de fluido obtenemos que nuestro producto:

- Ofrece un calentamiento más rápido.
- El reparto de temperatura es más equilibrado debido a que cada elemento porta una resistencia de 130 W (113 Kcal/h) en su interior, lo que hace al radiador más eficiente.
- Al tener más resistencias, la carga de trabajo en estas disminuye con lo que conseguimos una mayor duración de las resistencias.
- Al no llevar fluidos las presiones que ejercen estos elementos desaparecen y se hace innecesaria la utilización de juntas. Con ello, el riesgo de fugas queda limitado al máximo.

DATOS TECNICOS

Bloque de aluminio inyectado relleno de compuesto **CSR**.

Resistencias blindadas en tubo inoxidable **AISI-304**.

CE – ENAC: Todos nuestros productos están certificados por laboratorios acreditados por ENAC, tanto para ensayos de SEGURIDAD general y particular, así como para ensayos de COMPATIBILIDAD ELECTROMAGNÉTICA.

CALCULO DE NECESIDADES

Para conseguir el Confort deseado debemos conocer las necesidades en Watios que requiere cada habitación. Para ello realizaremos los siguientes cálculos:

1º Calcularemos el volumen de la habitación: $ALTO \times ANCHO \times LARGO = m^3$.

2º Este resultado lo multiplicaremos por los siguientes estándares:

- 38 wat. Si deseamos calentar un BAÑO o un SALÓN,
- 32 wat. Si deseamos calentar un DORMITORIO o un PASILLO,
- 28 wat. Si deseamos calentar una COCINA.

3º En el supuesto de que la habitación a calefactor esté orientada hacia el Norte, sea muy acristalada o tenga un aislamiento sencillo,

multiplicaremos el último resultado por el Coeficiente Corrector: 1,10. En caso contrario, omite este punto y pase al punto 4º.

4º Observemos ahora el mapa de Zonas Climáticas para ubicar nuestra posición y la zona climática correspondiente.

- Si nuestra ubicación se encuentra dentro de la **ZONA 1**, multiplicaremos nuestro último resultado obtenido por 0,90.
- Si nos encontramos dentro de la **ZONA 2**, multiplicaremos por 1.
- Si nos encontramos dentro de la **ZONA 3**, multiplicaremos por 1,10.
- Si nos encontramos dentro de la **ZONA 4**, multiplicaremos por 1,20.
- Y si nos encontramos dentro de la **ZONA 5**, multiplicaremos por 1,30.

Esta última cifra obtenida representa los WATIOS necesarios y/o aconsejados para calentar la habitación calculada. Utilice este resultado para saber la cantidad de elementos (mediante la aproximación en Watios) necesarios para conseguir el CONFORT DESEADO para su habitación. Este dato lo puede encontrar en las Características Técnicas.



CARACTERISTICAS TECNICAS

Nº Elementos	4	6	8	10	12
Potencia (W):	520	780	1.040	1.300	1.560
Potencia (Kcal/h):	447	671	895	1.118	1.342
Tensión (V):	230V 50Hz	230V 50Hz	230V 50Hz	230V 50Hz	230V 50Hz
Dimensiones:					
A (mm)	600	600	600	600	600
L (mm)	406	564	722	880	1.040
P (mm)	95	95	95	95	95
Peso (Kg.):	10	14	18	22	26
PRECIO	291,67 €	330,00 €	390,00 €	455,00 €	508,33 €

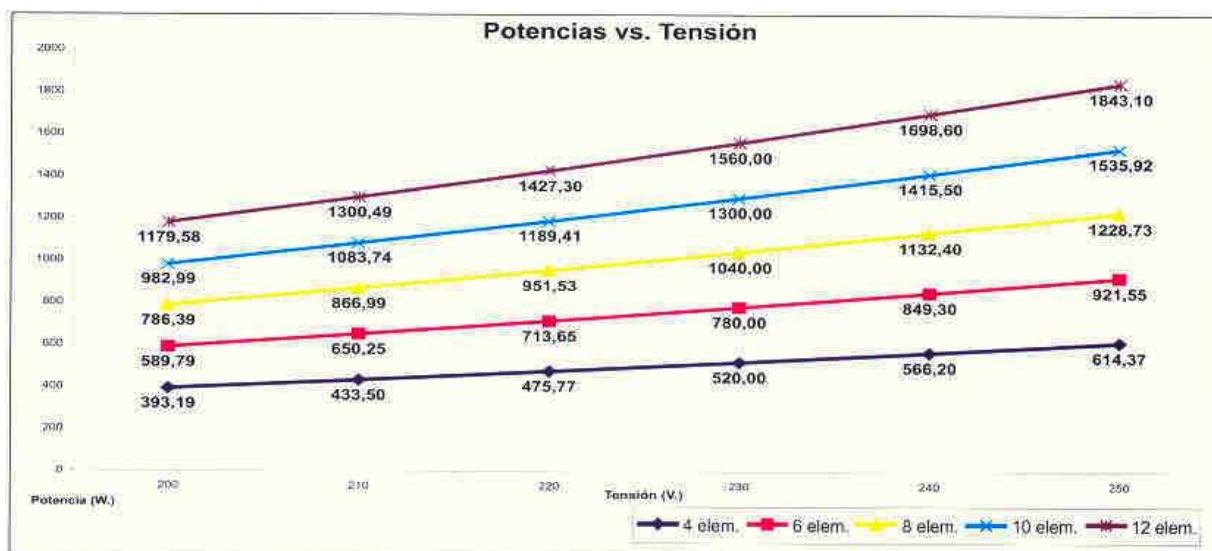

VALVULAS ESFERA SERIE EMPO

PRESION NOMINAL 30 AT

ROSCAR
 H - H



Construida en latón OT-58
 Junta metálica de seguridad
 Asientos Pffe.
 Temp. Max. 150°C

MEDIDA	UN	PRECIO
1/2"	10	9,32 €
3/4"	6	13,13 €
1"	4	15,05 €

SOLDAR



Construida en latón OT-58
 Junta metálica de seguridad
 Asientos Pffe.
 Temp. Max. 150°C

MEDIDA	UN	PRECIO
12 x 12	10	5,95 €
14 x 14	10	5,95 €
15 x 15	10	7,11 €
16 x 16	10	7,43 €
18 x 18	10	7,56 €
22 x 22	6	9,18 €
28 x 28	4	11,90 €

VOLANTES PARA VALVULAS ESFERA SERIE EMPO

VOLANTE
 PALANCA
 NURY

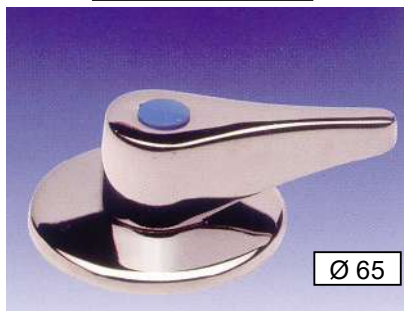

Ø 65

UN	PRECIO
15	5,16 €

VOLANTE
 OCULTO
 TON



Ø 65

UN	PRECIO
15	5,10 €

03/02/2022

Colectores Tubo Reticulado



2 Conexiones Art. 1952	
Medida	PRECIO
3/4 x 15 sp. 2.5	9,12 €
3/4 x 16 sp. 2.0	9,12 €
3/4 x 16 sp. 2.2	9,12 €
3/4 x 18 sp. 2.5	9,67 €

3 Conexiones Art. 1953	
Medida	PRECIO
3/4 x 12 sp. 2.0	12,42 €
3/4 x 15 sp. 2.5	12,42 €
3/4 x 16 sp. 2.0	12,42 €
3/4 x 16 sp. 2.2	12,42 €
3/4 x 18 sp. 2.5	13,00 €

4 Conexiones Art. 1954	
Medida	PRECIO
3/4 x 15 sp. 2.5	15,38 €
3/4 x 16 sp. 2.0	15,38 €
3/4 x 16 sp. 2.2	15,38 €
3/4 x 18 sp. 2.5	17,10 €

Colectores Trefilados



Medida	Conexión	Codigo	PRECIO
3/4" - 1/2"	2	314022	10,72 €
3/4" - 1/2"	3	314023	14,32 €
3/4" - 1/2"	4	314024	17,45 €
1" - 1/2"	2	314013	13,22 €
1" - 1/2"	4	314015	23,77 €
1" - 1/2"	6	314017	33,85 €

Colectores con Valvula de Regulación



MEDIDA	VIAS	UN	PRECIO
3/4"	2	12	18,15 €
3/4"	3	8	25,73 €
3/4"	4	6	34,49 €

MEDIDA	VIAS	UN	PRECIO
1"	2	8	18,37 €
1"	3	6	26,74 €
1"	4	4	35,82 €

Colectores Modulares Niquelados

para tubo de cobre / multicapa / reticulado / PP / PB

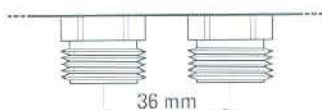

36 mm
Distancia entre tomas

CODIGO	MEDIDA	VIAS	UN	PRECIO
01303050	3/4"	2	10	8,26 €
01303052	3/4"	3	6	11,35 €
01303054	3/4"	4	10	15,02 €
01303060	1"	2	8	10,75 €
01303062	1"	3	10	14,49 €
01303064	1"	4	8	18,39 €

Varios calefacción

RELOJ PROGRAMADOR



Reloj programador diario a cuarzo con reserva de carga (72h).
Contactos en conmutación (16/250V)
Cuadrante de segmentos de 10 minutos
Alimentación 230Va.c. 50/60 Hz.
Medida 72 x 72 mm

CODIGO	UN	PRECIO
CO16201	1	85,70 €

FILTRO DE RECIRCULACION GAS-OLEO PN-6



Filtro de recirculación de gas-óleo 13961 PN-6 de alta calidad. Elimina el retorno a tanque. Incorpora grifo de regulación, válvula de compensación de presión tarada a 0,8 bar para el retorno de la bomba del quemador, válvula antirretorno, sistema de purga con tubo de plástico para puesta en marcha, cartucho filtrante standard de fieltro y soporte de fijación a pared.

500 ERAZ

CODIGO	ENVASE	PRECIO
0382068176	1	59,37 €

VALVULA PIE GASOLEO DOBLE BOLA

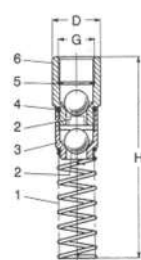

- Temperatura máx. 100 °C
- Presión máx. 6 bar.

- 1 Acero tropicalizado
- 2 Acero cromado
- 3 Latón OT-58 UNI5705
- 4 OR Goma NBR
- 5 Acero tropicalizado
- 6 Latón OT-58 UNI5705

G 3/8" 1/2"
H 97 105
D 22 28

CODIGO	MEDIDA	UN	PRECIO
GA09012	3/8"	6	10,03 €
GA09011	1/2"	6	8,30 €

MEZCLADOR TERMOSTATICO

CALEFFI 520

Válvula mezcladora termostática H-H para instalaciones con acumulador



CODIGO	MEDIDA	UN	PRECIO
	1/2"	2	54,20 €
	3/4"	2	56,93 €
	1"	2	58,81 €

FILTRO GAS-OLEO OVENTROP SIKU 50-75 µ

Vaso de plástico transparente. Solo para aspiración.

Cauda: 3/8" (DN10) entre 600 l/h (limpio) y 200 l/h (obstruido 80%)

CODIGO	MEDIDA	UN	PRECIO
302124361	3/8"	1	40,63 €



CODIGO	DESCRIPCION	UN	PRECIO
302126300	SIKU 50-75	1	5,92 €
302126751	Vaso	1	6,86 €
302126500	Juntas	1	1,57 €



KIT RACORES TACO-MIX



Roscar, para válvula mezcladora termostática MT53 (3 Ud. por kit)

CODIGO	MEDIDA	PRECIO
663110	H 3/4" x M 1/2"	20,94 €

TIGER LOOP ORIGINAL



Purgador de aire para alimentación de quemadores de gasoleo. Presion 6 bar.

CODIGO	PRECIO
0382062595	79,08 €

TIGER LOOP COMBI



Purgador de aire para alimentación de quemadores de gasoleo "con filtro incorporado". Presion 6 bar.

CODIGO	PRECIO
0382062607	190,00 €

Nº 115

Bombas circulación



NMT PLUS

Modelo	Distancia entre bridas	PRECIO
NMT PLUS 25/40	130	169,69 €
NMT PLUS 25/40	180	169,69 €
NMT PLUS 25/60	130	176,20 €
NMT PLUS 25/60	180	176,20 €

AVANSA®



Modelo	Distancia entre bridas	PRECIO
25 - 40	130	77,22 €
25 - 40	180	90,70 €
25 - 60	130	80,43 €

wilo



WILO YONOS PICO
Electrónica.
Eficiencia energética clase A.
Regulación: presión constante, proporcional, curva constante.
Presión máx.: 10 bar.
Temp. trabajo: 2+110° C.
Alimentación: 230 V., 50 Hz.
Protección eléctrica IP 42.
Regulación: 3 velocidades.
Conexión cuerpo bomba:
130 mm. - DN 25 1/4" M.
180 mm. - DN 25 1/2" M.

Modelo	Distancia entre bridas	PRECIO
YONOS RS 25-6 RKC	130	151,67 €
YONOS RS 25-6 RKC	180	151,67 €
YONOS RS 25-7,5 RKC	180	194,00 €

		PRECIO
JUEGO RACORES C/JUNTA	1 1/2" - 1"	7,19 €

ES2 PURE



CAMPO DE APLICACIÓN

Instalaciones de recirculación de agua caliente sanitaria y sistemas de circulación análogos en los sectores residencial e industrial. Este modelo está indicado sólo para agua potable.

Temperatura del líquido
+2°C a +95°C

Presión del sistema
Max 1.0 MPa - 10 bar

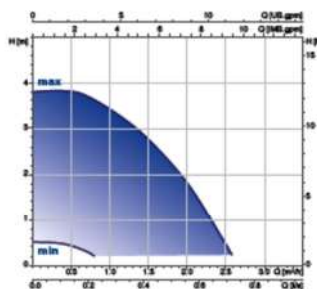

P1max = 40W

PRECIO
198,00 €

GARANTIA: 5 AÑOS

DELAVAN



	0,40	0,50	0,55	0,60	0,65	0,75	0,85	1,00	1,50
45°		9,55		9,55	9,55				
60°	9,55	9,55	9,55	9,55	9,55	9,55	9,55	9,55	9,55
80°		9,55		9,55	9,55				

No 116

VALVULA DE ZONA CON MICROINTERRUPTOR

PTM MU

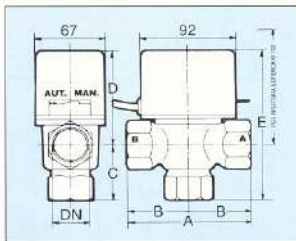

ART. 547			
MEDIDAS			
	1/2"	3/4"	1"
A	92	92	92
B	46	46	46
C	46	46	46
D	79	79	84

MEDIDA	ENVASE	PRECIO	
		2 VIAS	3 VIAS
3/4"	2	135,43 €	141,50 €
1"	2	135,43 €	147,78 €



F/2000
Termostato blindado con bulbo y capilar. Contactos en conmutación. Poder de ruptura: 16(4) A-400 V. del capilar 1500 mm.

CODIGO	ESCALA	DIF.	Long. Mm	PRECIO
3F2000	30 + 90 °C	± 4 °C	1500	22,80 €



B/2000
Termostato de contacto directo para tubería. Caja de protección de resina, con muelle de sujeción. Contactos con conmutación. Poder de ruptura: 10(2) A-250V.

CODIGO	ESCALA	DIF.	PRECIO
3B2000	30 + 90 °C	± 3 °C	17,64 €



C/2000
Termostato de inmersión con bulbo rígido. Vaina de latón niquelado 1/2". Caja de protección de resina. Contactos en conmutación. Poder de ruptura: 10(2) A-250 V. Diferencial: 6°C.

CODIGO	ESCALA	DIF.	Long. Mm	PRECIO
3C2001	30 + 90 °C	± 4 °C	100	26,67 €
3C2002	30 + 90 °C	± 4 °C	240	26,67 €

VASOS EXPANSION DE CALEFACCION
Brida en acero inox



Acero Esmaltado
Prex. Max.: 5 bar
Temp. Max.: 99 °C
Empalme conexión

CAPACIDAD	PRECIO
8 Litros	36,08 €
12 Litros	44,54 €
18 Litros	47,30 €
24 Litros	54,70 €
40 Litros	76,89 €
60 Litros	107,13 €

SOPORTE PTM

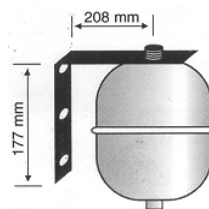

Para vasos de expansión entre 6 y 35 litros. Construcción en chapa zincada de 40 x 4 mm.

PRECIO
24,00 €

VASOS EXPANSION DE A.C.S.
Brida en acero inox



Protección interna anti-calcareo y anticorrosión en polipropileno.

CAPACIDAD	PRECIO
5 Litros	36,52 €
8 Litros	39,52 €
12 Litros	42,09 €
18 Litros	42,48 €
24 Litros	44,91 €

EMBELLECEDOR PASAMUROS. Para tubo de 8 a 22 mm

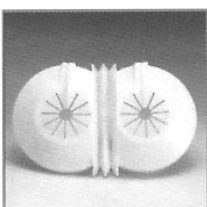
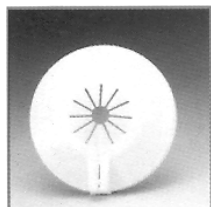

TIPO	CANT.	PRECIO
Sencillo	100	0,27 €
Doble	100	0,65 €

IP 55



IP 50



PROBADAS AL 100%
UNI 8858
CE

Valvula a esfera motorizada

Aplicaciones

La válvula a esfera motorizada Modulo Compact está preparada para las instalaciones por zonas, para uso en energías alternativas, para instalaciones de riego automático y más en general para instalaciones domésticas e industriales con fluidos calientes y fríos no agresivos. El servomotor está dotado de indicador de: "válvula abierta", en los modelos a tres vías, "flujo desviado" en los modelos a cuatro vías. Además está provisto de un contacto abierto en la salida para su utilización conjunta con una caldera, un contactor, una bomba circuladora o de un utilizador genérico alimentado de 6 a 230 V.

Datos técnicos válvula

Cuerpo en latón ST UNI EN 12165 CW617N niquelado
Esfera en latón ST UNI EN 12165 CW617N cromado
Límites de funcionamiento de -40 a 100 °C (fluido circulante)
Presión de ejercicio PN 40
Presión diferencial máxima 6 bar
Estanquidad sede esfera PTFE
Estanquidad eje de maniobraHNBR

Datos técnicos servomotor

Alimentación 230 V / 50 Hz
Absorción 4 VA
Ángulo de rotación 90° (2 vías) - 180° (3 vías) - 90/270° (4 vías)
Tiempo de maniobra 60" (2 vías) - 120" (3 vías) - 60/180" (4 vías)
Par 14,5 Nm (230 V) - 12,5 Nm (24 V)
Contacto auxiliar 1 - abierto 5 A / 230 V (on-off)
Grado de protección IP 55 - IP 50
Clase de aislamiento II
Indicador Válvula Abierta (2 vías) Flujo desviado (3 vías / 4 vías)



CODIGO	MEDIDA	VIAS	UN	PRECIO / Ud.
01425806	1/2"	3	1	141,47 €
01425808	3/4"	3	1	160,38 €
01425810	1"	3	1	182,01 €



CODIGO	MEDIDA	VIAS	UN	PRECIO / Ud.
1425800	1/2"	2	1	145,71 €
1425802	3/4"	2	1	165,20 €
1425804	1"	2	1	187,48 €

Termostatos Ambiente

TA 03 CALEFACCION



3 contactos, conmutado con interruptor ON/OFF y luz piloto.
Escala regulación: 5-30° C.
Diferencial ± 1° C.
Alimentación: 250 V 50 Hz., (abre/cierra) 2 hilos.
Grado protección: IP 20.

ENVASE	PRECIO
6	16,70 €

Termostato de ambiente electrónico digital BTD

Termostato de ambiente electrónico con pantalla digital de grandes dimensiones y con temporizador. Para instalaciones de Calefacción.

-Regleta de conexiones: desmontable (screw)
-Rele: 5(3)A/250V
-Regulación: + 5°C a +35°C
-Diferencial de temperatura: 0,1°C
-Protección: Clase II IP30
-Alimentación: Baterías 2x1,5VAAA
-Medidas: 80x83x23mm
-Apto para "Cajetín de obra"



	UN	PRECIO/UN
BTD	20	67,99 €
Sonda NTC	20	10,29 €



Cronotermostato electrónico ECOLUX

El Chrono Battery Electronic es un termostato electrónico con reloj programador mecánico diario o semanal.

- Dos temperaturas: ☀ Confort y 🌙 Reducida
- Reloj indicador de la hora
- Se suministra con pilas

-Alimentación 2 pilas AA LR06 1,5V.
-Potencia contactos 8(3)A / 250Vac.
-Protección eléctrica Clase II IP30.
-Normativa CE.

-Regulación de temperatura 5°C a 35°C.
-Reloj programador diario 24h pasos de 15 min.

ENVASE	PRECIO
4	69,56 €



Cronotermostato electrónico digital BTD P

Termostato electrónico digital programable con pantalla digital de grandes dimensiones. Para instalaciones de Calefacción.

- Display: pantalla LCD retroiluminada (blacklight)
- Función ON-OFF
- Modo: confort, automático, reducida, antihielo, selector programación, bloqueo, vacaciones, etc.
- Regulación: interna o externa o combinada (sensor NTC)
- Se suministra con pilas
- Programador: diario o semanal
- 9 programas configurados y 4 libres
- Puedes activar o desactivar la función ICTS

-Regleta de conexiones: desmontable (screw)
-Rele: 5(3)A/250V
-Regulación: + 5°C a +35°C
-Diferencial de temperatura: 0,1°C
-Protección: Clase II IP30
-Alimentación: Baterías 2x1,5VAAA
-Medidas: 80x83x23mm
-Apto para "Cajetín de obra"

REFERENCIA	DESCRIPCION	UN	PRECIO/UN
BTD P	Semanal	30	78,75 €
Sonda NTC	10 kΩ a 25 °C	30	10,29 €

Honeywell CM901 - CM907



Chronotherm® serie CM

- Control proporcional + integral
- Margen de regulación 5-35 °C
- Interruptor unipolar inversor (SPDT) libre de potencial
- 24V... 230V/50Hz - 8(3)A
- Pantalla retroiluminada - Texto dinámico de ayuda
- Control telefónico mediante módulo accesorio
- Programa diario-semanal - 6 cambios por día
- Limitación de la temperatura

REFERENCIA	DESCRIPCION	UN	PRECIO/UN
CM901	Diario	1	159,12 €
CM907	Semanal	1	204,89 €

Honeywell T4 R

Radiofrecuencia



- Cronotermostato con programa diario, semanal o 5+2
- 4 ó 6 periodos de hora y temperatura por día
- Diseño moderno y elegante
- Pantalla gran tamaño retroiluminada y fácil de leer
- Funciones de optimización avanzada para alcanzar la temperatura deseada en el momento oportuno
- Interruptor unipolar inversor (SPDT) libre de potencial 24V... 230V/50Hz - 5(3)A
- Montaje rápido y sencillo, configuración rápida y sencilla mediante su menú de iconos
- Programación de fábrica para un uso inmediato
- Módulo relé incluido (solo T4R)
- Alimentado por pilas (incluidas)

ENVASE	PRECIO
1	266,53 €

Varios Calefacción

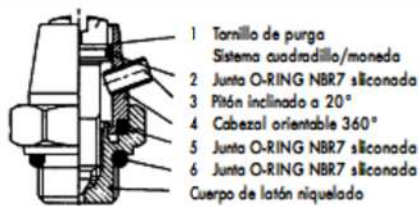

Purgador Manual
"MPS" 1/8"

ENVASE	PRECIO
100	1,43 €



Tapón purgador automático de boya cromado para radiador. Tapón de purga no extraíble y junta de goma cónica para conexión a radiador. Presión máxima 10 bar. T. max.: 100 °C

870 RAPIDUR
Purgador automático boya

ENVASE	PRECIO
12	5,45 €



TACO-VENT
Purgador automático de discos

PURGADOR AUTOMATICO DE DISCOS DE 1/8"

ENVASE	PRECIO
6	3,23 €

PURGADOR AUTOMATICO

Presión Máxima: 10 Kg/cm2
Temperatura Máxima: 115 °C
ISO 228

MEDIDA	UN	PRECIO
3/8"	6	8,63 €
1/2"	6	9,38 €

Valvulas de seguridad DUCO taradas



Válvula de seguridad H-H sin toma portamanómetro. Conexión: 1/2". Descarga: 3/4".

CODIGO	MEDIDA	PRESION	PRECIO
101241N	1/2" x 3/4"	3 bar	8,26 €
101251N	1/2" x 3/4"	3,5 bar	8,95 €
101261N	1/2" x 3/4"	4 bar	8,95 €
101800N	1/2" x 3/4"	5 bar	8,95 €
101801N	1/2" x 3/4"	6 bar	8,95 €
101831N	1/2" x 3/4"	7 bar	8,95 €
101811N	1/2" x 3/4"	8 bar	8,95 €
101821N	1/2" x 3/4"	10 bar	8,95 €

Valvulas de seguridad térmica



CODIGO	MEDIDA	PRESION	PRECIO
319309530	3/4" x D22	3 bar - 90°	58,53 €
	3/4" x D22	4 bar - 90°	58,53 €
319309440	1/2" x D15	4 bar - 90°	51,38 €



Válvula de seguridad H-H. con toma portamanómetro 1/4" H (manómetro no incluido en precio). Conexión: 1/2". Descarga: 3/4".

CODIGO	MEDIDA	PRESION	PRECIO
1005-036	1/2" x 1/2"	3 bar	7,92 €
101540N	1/2" x 3/4"	3 bar	12,39 €



FILTRO GASOLEO AL-PLAS

ENVASE	PRECIO
6	10,03 €



FILTRO GASOLEO TODO ALUMINIO

ENVASE	PRECIO
6	8,78 €

Latiguillos especiales para quemadores de gasóleo con refuerzo metálico, tuercas con cono estanco según normas DIN EN ISO 6806



Conexión 3/8" H-H



Conexión 3/8" H-M



Conexión recta diámetro 8 mm x codo 90° con racor macho rosca 14 x 1,5

CALIDAD ALEMANA

REFERENCIA	MEDIDA	PRECIO
2742	H3/8" H3/8" x 1000	25,30 €
	H1/4" H3/8" x 1000	11,90 €

REFERENCIA	MEDIDA	PRECIO
2730	M1/4" H3/8" x 1000	11,90 €

REFERENCIA	MEDIDA	PRECIO
4127	M1/4" H3/8" x 1000	16,37 €
4547	H1/4" H3/8" x 1000	15,32 €
4676	H3/8" H3/8" x 1000	32,38 €



KIT DE ASPIRACIÓN METÁLICO GOK

- Conexión a depósito 1"
- Palanca de seguridad metálica
- Válvula anti-retorno
- Conexiones para tubos ida-retorno a 3/8" con racores metálicos y ovalillos ø 8, 10 mm
- Sonda de aspiración de goma especial para gas-óleo long. 2,150 m con contrapeso y distanciador tipo estrella

REFERENCIA	MEDIDA	PRECIO
001209	1"	44,98 €

VALVULA RELLENO AUTOMATICO 1/2"

Para instalaciones de calefacción en circuito cerrado:
Reducción de presión – Retención – Cierre - Filtro



ENVASE	PRECIO
2	41,39 €

GRUPOS DE SEGURIDAD 4 SERVICIOS

Aplicaciones

Grupos de seguridad 4 servicios de alta calidad, concebidos para instalaciones de agua caliente sanitaria. Combinan cuatro funciones: seguridad, retención, descarga, cierre y apertura manual.

GRUMIX

Grupo seguridad tipo Francia para acumuladores. Fabricado en latón no desoxidable. Para circuitos de calefacción hasta una potencia máxima de 10 Kw o en acumuladores A.C.S. con capacidad de hasta 300 lts. Conexión entrada 3/4" H. Conexión descarga 1" M. Certificaciones: NF D3640 1/EN 1487



REFERENCIA	MEDIDA	PRESION	PRECIO
870020	3/4"H – 1"M	7 bar	39,52 €



BOYATEX GOK

Indicador de nivel mecánico con boya, lectura vertical. Conexión a depósito 2" hermético. Válido también para combustibles BIO.



VÁLIDO TAMBIÉN PARA COMBUSTIBLES «BIO»

ESTANCO (ANTI-OLOR)

REFERENCIA	MEDIDA	PRECIO
000212	0-200 cm	17,66 €

GRUPO COMBINADO PARA TANQUES DE GASOLEO

Grupo combinado de latón para tanques de gasóleo.

Comprende: Válvula de retención, palanca de interrupción rápida, sonda para indicador de nivel TELEVAR, conexiones de ida y retorno al tanque con casquillos para tubo de Ø 6x8 – 8x10 – 10x12 mm.

Tubo de aspiración de gasóleo y sonda indicadora y nivel en Perbunan. Con contrapeso.



MBO220

REFERENCIA	DESCRIPCION	PRECIO
0108300	Sonda 2200 mm sin conexión para nivel	31,62 €

Machón

REFERENCIA	MEDIDA	PRECIO
PR8572	C 3/8" x 3/8"	2,98 €
PR8571	C 1/4" x 3/8"	2,98 €

Escobillones calefacción



ESCOBILLÓN DE ACERO CON RACOR HEMBRA DE 12/175 Rectangular

REFERENCIA	MEDIDA	PRECIO
501040	80 x 45	22,90 €
501050	100 x 50	23,30 €
501060	120 x 60	25,80 €



GRUPO PARA SISTEMA ENERGIA SOLAR

Conexión al circuito de calefacción: 3/4"
Conexión al generador: 3/4"
Presión: PN 6
Temperatura de trabajo: 110 °C
Rango regulador de caudal: 1-19 l/min.
Máxima temperatura: 130 °C (corto plazo)

Los grupos para sistemas de energía solar incorporan además:
- Válvula de seguridad tarada a 6 bar.
- Manómetro de 0-10 bar.
- Conexión macho 3/4" para fijar al vaso de expansión.
- Regulador de caudal integrado con indicador.

Descripción	Referencia	PRECIO
Grupo de circulación simple. Bomba Wilo ST25-6-3/4" - Sistema Energía Solar	38.414	293,17 €
Grupo de circulación doble. Bomba Wilo ST25-6-3/4" - Sistema Energía Solar	38.415	347,93 €

Purgador automático SOLAR-VENT (especial altas temperaturas)

Purgador para desaireación automática para:
Instalaciones solares, vapor, agua sobrecalentada,
calefacción, refrigeración de agua y redes sanitarias.
Incluye válvula de retención automática, instalada en
la red de tuberías y el purgador, se abre si el purgador
está roscado, y se cierra automáticamente si se quita
e purgador "Solar-Vent"

CARACTERISTICAS TECNICAS:
Purgador de aire de acción rápida controlado
por flotador de acero inox, cuerpo de latón.
Junta resistente a las altas temperaturas y a los
productos anticongelantes.
Disponible en dos medidas, rosca macho de
3/8" y 1/2".



Referencia	Medida	UN	PRECIO
591000	3/8"	5	78,90 €
591400	1/2"	5	78,90 €

NOVEDAD

SOLIDO
ROBUSTO
FIABLE

Purgador automático de boya SOLAR – ECO



325 MINI

Cuerpo de latón estampado.
Con descarga lateral.
Presión máx.: 10 bar.
Temp. máx.: 180° C.
Acabado: latonado.

Referencia	Medida	UN	PRECIO
083252	3/8"	10	11,16 €
083255	1/2"	10	12,25 €

Líquido anticongelante y anticorrosivo

ANTIFROST RC
Etilenglicol 100
Para instalaciones de
calefacción, geotermia
y refrigeración.



-10°C	20%	80%
-15°C	25%	75%
-18°C	30%	70%
-28°C	40%	60%
-37°C	50%	50%

Referencia	Capacidad	PRECIO
502110	Bidón de 10 lts	59,70 €

Válvula de equilibrado estático roscada



Ventajas

- Garantía de 5 años
- Todas las válvulas de equilibrado se instalan indistintamente en el circuito de ida o retorno y en todas las posiciones, aunque se recomienda montarlas en el retorno.
- Circulación del fluido en los dos sentidos, pero se aconseja respetar el sentido de A hacia B (marcado en el cuerpo de la válvula) para conseguir de la válvula una precisión óptima.
- El volante digital tiene 40 posiciones de reglaje de 1/10 de vuelta cada posición.
- La lectura de la posición se puede realizar por encima y por debajo de la válvula.
- Un doble bloqueo del reglaje es posible gracias al precintado de la memorización y del volante de reglaje.
- La válvula de equilibrado puede desempeñar la función de aislamiento
- Permite a su vez el vaciado y el llenado de la instalación incorporando la válvula de vaciado

Valvula roscada con 2 tomas de presión

REFERENCIA	Ø	Kv (m ³ / h)	UN	PRECIO
741406	3/4"	0,13 – 5,9	1	50,98 €
751408	1"	0,17 – 8,52	1	59,53 €



MANTA 700 °C

Manta protectora para trabajos de soldadura directa, especialmente desarrollada para evitar el paso del calor a los materiales sensibles próximos a zonas de trabajo. **Resistencia máxima 700 °C**

REF.	COLOR	Medidas	PRECIO
730700	Negro	33 x 20 cm	52,43 €

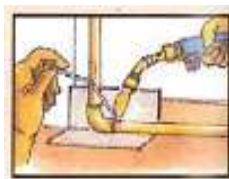

REPARADOR

Reparador de fragmentos y rayaduras, para cualquier superficie esmaltada (lavabos, baños, azulejos, fregaderos, cocinas, neveras, etc.)
Tubo 20 ml.

PRECIO
4,66 €



POLVO LIMPIADOR DE HOLLIN C-20

Limpiador de hollín y alquitrán en estufas y chimeneas.

PRECIO
14,62 €



LIMPIADOR DE CALDERAS

Elimina las incrustaciones de hollín, aumentando el rendimiento de la caldera y evitando la formación de nuevo hollín.

PRECIO
14,98 €



NEUTRALIZANTE

Evita los ruidos que se producen en los radiadores de aluminio.

PRECIO
13,72 €



JABON LIQUIDO KIMSA 1 Litro con aceite de coco

PRECIO
15,23 €

Con 1 Litro se preparan 2 Litros de jabón.

No agrieta las manos.



DESATASCADOR GYMCOL 500ml

PRECIO
7,19 €



DESATASCADOR KIMSA 1 Litro

PRECIO
33,58 €

	SILICEX SANITARIOS	FISCHER CONSTRUCCION	R - 70 ALTA RESISTENCIA	S - 50 ALTA RESISTENCIA	MS SELLANTE
	Silicona Sani 	Silicona Neutra 	Masilla Refractaria 	Juntas Alta Temperatura 	Sellador de Polímero MS
	Elastómero de silicona monocomponente que reticula al entrar con la humedad del ambiente, transformándose en una masa elástica de muy buenas propiedades mecánicas y un excelente comportamiento frente a los agentes atmosféricos: ozono, UVA, Ta..., que superan la resistencia de cualquier otro tipo de mástico (poliuretano, polisulfuro, acrílica,...),	Elastómero de silicona monocomponente que reticula al entrar con la humedad del ambiente, transformándose en una masa elástica de muy buenas propiedades mecánicas y un excelente comportamiento frente a los agentes atmosféricos: ozono, UVA, Ta..., que superan la resistencia de cualquier otro tipo de mástico (poliuretano, polisulfuro, acrílica,...),	R-70 Masilla refractaria de base mineral resistente al fuego y las altas temperaturas (hasta 1500 °C). Indicado para calderas de calefacción, chimeneas, cocinas, barbacoas, etc. Preseta buena adhesión sobre hierro, cemento y ladrillos refractarios.	Silicona ácida para la formación de juntas elásticas en instalaciones industriales que deban soportar una elevada temperatura (conductos, estufas, ...). Permite hasta 250 °C de servicio continuo.	Sellante-adhesivo monocomponente de elevadas prestaciones mecánicas, diseñado par el sellado y pegado de materiales diversos. Presenta una excelente resistencia a la decoloración por exposición a los rayos U.V. No contiene disolventes, ni silicona, ni isocianatos y es inoloro, Aplicable sobre soportes húmedos o mojados.
OFERTA SELLANTE POLIMERO MS SILICONA 1 caja Dto. 3%	COLORES TRANSLUCIDO BLANCO	TRANSLUCIDO BLANCO	NEGRO	NEGRO	GRIS BLANCO TRANSLUCIDO TEJA
	PRECIO 300 ml 5,42 € 50 ml 1,87 €	PRECIO 7,02 €	UN 12 4,22 €	PRECIO 9,68 €	PRECIO 7,54 € TRASLUCIDO 9,90 €

NUEVA ESPUMA DE POLIURETANO COLLAK PU FOAM



ESPUMA PISTOLA	
CANTIDAD	PRECIO / UD
1 CAJA	8,48 €
5 CAJAS	7,83 €

ESPUMA CANULA	
CANTIDAD	PRECIO / UD
12	8,48 €
5 CAJAS	7,83 €

LIMPIADOR PISTOLA 500 gr	
CANTIDAD	PRECIO / UD
6	10,05 €

SU NUEVO TAPÓN PERMITE VOLVER A UTILIZARLA HASTA PASADOS 25 DÍAS

**MEJOR DOSIFICACIÓN
MÁS FACIL MÁS SEGURA**

SE PUEDE ALMACENAR EN CUALQUIER POSICIÓN

MAYOR CADUCIDAD HASTA 18 MESES

Nuestra Espuma está certificada por:



NUEVA ESPUMA DE POLIURETANO COLLAK PU FOAM

COLLAK



El principal problema en la manipulación y aplicación de espuma de poliuretano en bote es la válvula convencional de caucho:

- Por entrada de humedad por el caucho la espuma reacciona y la válvula queda pegada sin posibilidad de aplicar la espuma.
- La espuma sale por uno de los lados de la válvula, entre el plato metálico y el caucho de la válvula.
- El caucho se desliza por la parte inferior de plástico duro y la válvula queda abierta y bloqueada.



iiii PARA EVITAR TODOS ESTOS PROBLEMAS HEMOS SUSTITUIDO LA VÁLVULA TRADICIONAL POR UNA VÁLVULA SIN CAUCHO!!!!



Y ADEMÁS EN LA NUEVA CÁNULA QUE PERMITE UNA MEJOR DOSIFICACIÓN SE HA INCORPORADO UN TAPÓN QUE PERMITE REUTILIZAR LA ESPUMA DURANTE MUCHO MÁS TIEMPO CON EL CONSIGUIENTE AHORRO ECONÓMICO PARA EL USUARIO

Y RECUERDE QUE CON NUESTRA NUEVA ESPUMA PODRÁ ALMACENAR LOS ENVASES EN CUALQUIER POSICIÓN





UNEPLAS GEL

Certificación para agua potable.

Adhesivo especial para tubería de PVC rígido y sistemas de presión. Adhesivo con marcado CE, 2 años de caducidad. Consistencia Gel.

PEGAMENTO PVC

ARTICULO	ENVASE	PRECIO
TUBO 60gr	24	2,95 €
TUBO 125gr	50	3,80 €
TUBO 125gr	100	3,67 €
BOTE 250gr	12	8,06 €
BOTE 250gr	36	7,66 €
BOTE 500gr	12	13,90 €
BOTE 500gr	24	13,16 €
BOTE 1Kg	6	25,39 €
BOTE 1Kg	24	22,84 €
LIMPIADOR PVC 250ml	12	5,33 €

Los botes incluyen pincel

Adhesivo de PVC azul, muy rápido y tixotrópico.

Para pegar mangueras flexibles y tubos de PVC rígidos, manguitos y empalmes con ajustes encajados y más holgados (relleno de ranuras) en sistemas de presión y desagüe. Extremadamente apto para, entre otros, piscinas, bañeras con hidromasaje y aplicaciones bajo condiciones húmedas. Apto para diámetros ≤ 160 mm. Máx. 16 bar (PN 16). Tolerancia máxima de 0,8 mm de diámetro de ajuste holgado (mangueras flexibles máx. 0,3 mm) / 0,2 mm con ajuste forzado. Apto para, entre otros, sistemas de tuberías conformes con las normativas EN1329, 1452, 1453, 1455 y ISO15493 (PVC).

**Adhesivo rápido.
Pega incluso sobre
superficies húmedas.**

WDF-05



UN	PRECIO
1	8,49 €
12	8,06 €

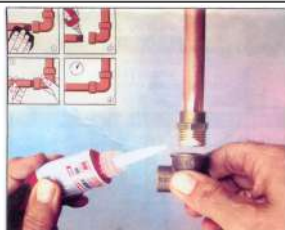

TEFLON LIQUIDO

ENVASE	PRECIO
50 ml	14,00 €

**TACO
QUIMICO**
BUCHA QUIMICA

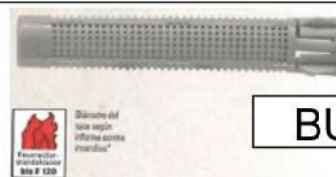

BUCHA

FIS H K / FIS H K

Tipo	Art. nº	EAN	Unidad mínima servicio	Embalaje	DT/CE	Ø	Profundidad mínima anclaje	Longitud taco	Adecuado para
FIS H 12x85 K	041901	8001132419014	caja(80)	caja(80)	DT/CE	12	95	85	MS-R

ENVASE	PRECIO
Caja 80 Ud.	39,29 €

**VINILESTER
FIS VS 300T
MULTI
MATERIALES**

Huecos/Hormigón

EXTRA RESISTENTE 800 Kg
SUPERFICIES HÚMEDAS

CERTIFICACIÓN CE

CTE

Nº Art. 510636

1 FJAC

Cartucho anclaje químico DIY FIS V - Multimateriales /
Cartucho bucha química DIY FIS V - Multimateriais

Tipo	Art. nº	EAN	Unidad mínima servicio	Embalaje	Caducidad
Resina DIY FIS V 300	510636	4040992102321	10	10	12 meses

Fijación de cargas pesadas en hormigón cuando el número de anclajes es reducido. Con pistola de silicona.

Fijación de máxima resistencia en ladrillo hueco o macizo y en bloques huecos.

UN	PRECIO
1	14,68 €
10	14,22 €

No 123

23/11/2022

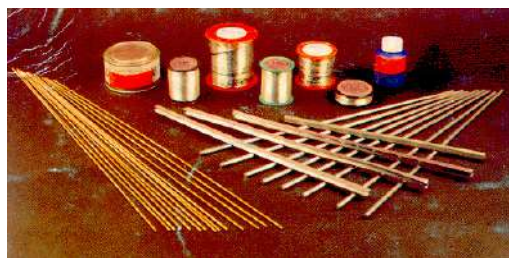

CODIGO		UN	PRECIO
0201100	ESTAÑO-PLATA 3,5% 100 gr.	12	9,10 €
0201253	ESTAÑO-PLATA 3,5% 250 gr.	12	15,95 €
0201550	ESTAÑO-PLATA 6% 250 gr.	12	21,82 €
0201850	ESTAÑO-PLATA 8% 250 gr.	6	43,98 €



CODIGO		UN	PRECIO
0500010	VARILLA PLATEX 2 mm	1 Kg	30,35 €
0500011	VARILLA PLATEX 3 mm	1 Kg	30,35 €

S-39° GEL

Gel de soldar universal y sin ácidos para soldaduras suaves de todo tipo de metales (excepto el aluminio y sus aleaciones) en prácticamente todos los campos de aplicación. Para uso en combinación con todo tipo de soldaduras de estaño macizas.



UN	PRECIO
10	5,40 €

REFERENCIA	PRODUCTO	UNIDADES / CAJA	EAN (UNIDAD)	EAN (CAJA)
1270051	FRASCO CON PINCEL 80 ML	16	8710439911137	8710439008370



LA-CO FLUX

Pasta decapante

No tóxico
No corrosivo
No es nocivo para la salud.
Es soluble en agua y puede aplicarse con las manos.

CODIGO	BOTE	UN	PRECIO
22110	60 gr	12	6,98 €
22137	125 gr	12	8,96 €



CODIGO		UN	PRECIO
0600001	PLATEX FLUX 100 gr	6	5,78 €
0600002	PLATEX FLUX 250 gr	6	10,00 €



CODIGO		UN	PRECIO
9908801	TEFLON 12 x 12 x 0,1	24	0,45 €
	TEFLON 12 x 12 x 0,1	250	0,43 €
9908807	TEFLON GRANDE 19 x 50	10	3,91 €
	TEFLON GRANDE 19 x 50	77	Dto. 5%

CODIGO		UN	PRECIO
0487002054	LANA ACERO 1 x 10	10	2,57 €
19	CAÑAMO EXTRATUBO 200gr	12	4,18 €
SET	TUBO SET GRIS 200 ml	12	6,51 €
1F.91100	ESTERINA	1 Kg	7,75 €
0101083	VARILLA ESTAÑO - PLOMO 33%	1 Kg	29,16 €
8444	CINTA AISLANTE 25 m x 19 mm	10	1,34 €
GEB104032	MASILLA SANITARIA 1 Kg	10	9,77 €



CINTA ALUMINIO 337: Cinta adhesiva para sellado de conductos de aire acondicionado, chimeneas, paneles aislantes con acabado exterior de aluminio etc.

CINTA AISLAMIENTO COQUILLAS 292E: Cinta adhesiva de PVC para acabado del montaje en coquillas de aislamientos térmicos flexibles (Climaflex, Armaflex, Tubex, etc.

CODIGO		UN	PRECIO
0487003100	CINTA ALUMINIO 10M x 50mm x 50 µ	24	3,22 €
487003132	CINTA COQUILLAS 15M x 50mm NEGRA	120	17,58 €

CINTA AMERICANA

CINTA UNIVERSAL DE ALTA CALIDAD



NUEVO

Cinta universal de alta calidad, profesional y reforzada con fibras



CODIGO		UN	PRECIO
6310239	CINTA AMERICANA UNIVERSAL GRIS	1	8,77 €
	ROLLO 25 METROS	24	7,76 €

CARACTERÍSTICAS

- Gran adherencia
- Resistente al agua
- Resistente a la intemperie
- Resistente a los rayos UV
- Estanca a los vapores
- Resistente a temperaturas entre -10 °C y +75 °C
- Se puede cortar a mano
- Hermética
- Resistente a presiones de hasta 4 bar

CAMPO DE APLICACIÓN

Apta para sellar, aislar, reparar, proteger, reforzar, fijar, sujetar y unir una gran cantidad de materiales. Apta para aplicaciones en interiores y exteriores. Se adhiere tanto a superficies lisas como rugosas, como piedra, hormigón, madera y plástico.



SFT-101 REPAIR

CINTA DE REPARACIÓN UNIVERSAL DE AUTOFUSIÓN, PARA SELLADO Y AISLAMIENTO A BASE DE SILICONA.

CAMPO DE APLICACIÓN

Apta para sellar y reparar de forma rápida y sencilla fugas en conductos, tuberías, conexiones, sifones y mangueras. Útil también para el sellado (impermeable) de conexiones eléctricas y el aislamiento y protección de enchufes y cables eléctricos. Se puede utilizar también para unir materiales y objetos, como protección contra el óxido y como antideslizante para mangos y herramientas. Aplicable en interiores, exteriores y bajo el agua.

CARACTERÍSTICAS

- Impermeable y estanco al aire inmediatamente
- Resistente a 12 bares de presión
- Aísla hasta 15 000 voltios por capa
- Resistente a las inclemencias del tiempo y a los rayos UV
- Resistente a temperaturas entre -54 °C y +260 °C
- Resistente a ácidos, alcalinos, disolventes, aceites, gasolina e hidrocarburos.
- Se puede estirar hasta un 300 %
- Elasticidad permanente
- Autofusión (autoadhesivo de efecto inmediato)
- Se puede corregir durante unos segundos
- Aplicable bajo presión
- Aplicable bajo el agua
- Se pueden poner cargas directamente
- Fácil de retirar
- No deja residuos de adhesivo

CODIGO	UN	PRECIO
6311144	6	11,85 €

REPAIR-POOL

ADHESIVO EPOXI BICOMPONENTE DE SECADO RAPIDO



Reparación de todo tipo de fisuras y grietas de hasta 10mm de grosor en piscinas o depósitos. Puede ser aplicado incluso bajo agua.

Apto para todo tipo de depósitos **excepto polietileno y polipropileno**.

Ideal para el pegado de piezas de gresite bajo agua.

Alta resistencia al cloro. Endurece en 10 minutos.

CODIGO	UN	PRECIO
75628	6	10,87 €

TAPONES FREGADERO



24	28	30	32	34	36	38	40	42	44	47	50	51	55	61
0,53	0,55	0,57	0,58	0,63	0,68	0,70	0,80	0,80	0,80	0,95	0,97	0,98	1,00	1,10

Universal
0,74

TAPON UNIVERSAL



Un solo tapón para la cocina, el cuarto de baño, ...
El tapón universal reemplaza a todos los tapones existentes, el diámetro de los cuales oscila entre 36 y 58 mm.
Material: PVC
Embalaje en blister transparente en PVC

COLOR	UN	PRECIO
Gris	10	4,00 €

TAPAORIFICIOS BIDE O LAVABO



	ENV.	PRECIO
CON TOMA	25	0,87
CIEGO CROMADO	25	1,01
CIEGO BLANCO	25	0,72

FLORONES ONDULADOS

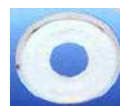

	ENV.	PRECIO
INOX 3/8"	25	0,30
INOX 1/2"	25	0,30

CADENA BOLAS CROMADA



	ENV.	PRECIO
LAVABO 25 cm	25	1,39
BANERA 45 cm	25	2,58

EJE PORTARROLLOS



ENV.	PRECIO
25	1,93

ESTOPA LINO



Económica: sin pérdidas.
De uso facil: seleccionar las cantidad tirando.
Práctica:poco voluminosa.

	PRECIO
Bobina de 80 gr con envase	12,84 €
Bobina de 80 gr sin envase	9,96 €

THOMSIT RS-88 Cemento Rápido



Cemento rápido para trabajos de montaje, nivelado y reparación. Reparación de escaleras, formación de rampas, relleno de grandes grietas, fijación de máquinas, pasamanos, cuadros eléctricos, etc...

No hay contracción de las pasta durante el secado, Interior y exterior.

Tiempo de trabajo: 10-25 minutos
Transitable a partir de: 30-60 minutos.

CODIGO	COLOR	ENVASE	UN	PRECIO
T800405	Gris	Bote de 5 Kg.	1	14,28 €

Juntas de Teflon

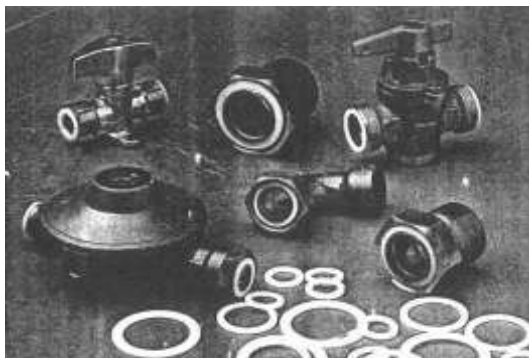

Junta RACOR LOCO

CODIGO	MEDIDA	UN	PRECIO / UD.
9908503	3/8"	100	0,08
9908504	1/2"	100	0,08
9908505	3/4"	100	0,10
9908506	1"	100	0,12
9908507	1 1/4"	100	0,24
9908508	1 1/2"	100	0,24
9908509	2"	100	0,34

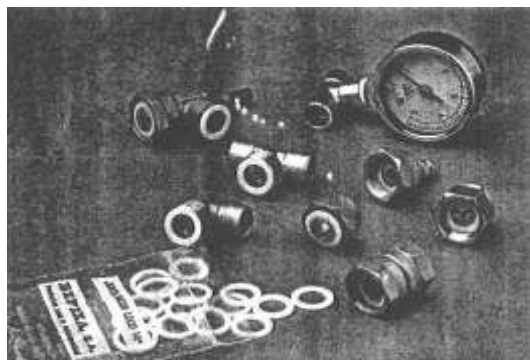

Junta HEMBRA ANCHA

CODIGO	MEDIDA	UN	PRECIO / UD.
9908203	3/8"	100	0,10
9908204	1/2"	100	0,12
9908205	3/4"	100	0,15
9908206	1"	100	0,18

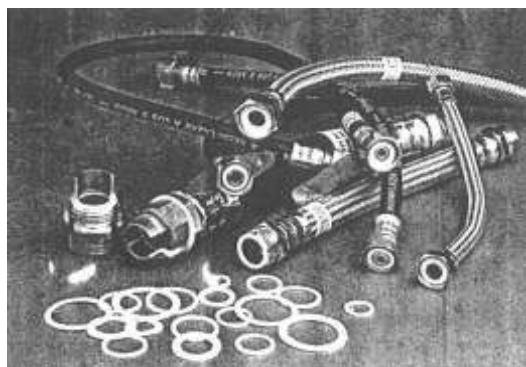

Junta MACHO

CODIGO	MEDIDA	UN	PRECIO / UD.
9908603	3/8"	100	0,12
9908604	1/2"	100	0,12
9908605	3/4"	100	0,15
9908606	1"	100	0,21
9908607	1 1/4"	100	0,25
9908608	1 1/2"	100	0,34
9908609	2"	100	0,39

Junta RADIADOR

CODIGO	MEDIDA	UN	PRECIO / UD.
9908001	1"	100	0,35



9908702

Cajas de Juntas

CONTENIDO			
RACOR LOCO		HEMBRA ANCHA	
MEDIDA	UN	MEDIDA	UN
3/8"	75	3/8"	40
1/2"	75	1/2"	40
3/4"	30	3/4"	30
		1"	10

PRECIO / UD.

27,38

No 126

JUNTA GOMA SEMICONICA



MEDIDA	ENV.	PRECIO
1/2"	50	0,30 €
3/4"	50	0,32 €
1"	50	0,33 €
1 1/4"	50	0,35 €
1 1/2"	50	0,37 €

JUNTA GOMA CONICA



MEDIDA	ENV.	PRECIO
1/2"	50	0,45 €
3/4"	50	0,47 €
1"	50	0,48 €
1 1/4"	50	0,50 €
1 1/2"	50	0,52 €

ENCHUFE GOMA CUBETA WC



MODELO	UNIDAD	PRECIO
LUCERNA Ø 25/30	25	1,64 €
VICTORIA	25	1,64 €



MODELO	UNIDAD	PRECIO
PENINSULAR Ø 25	25	1,70 €
PENINSULAR Ø 30	25	1,70 €

ARANDELA GOMA PLANA



MEDIDA	UNIDAD	PRECIO
3/8"	50	0,17 €
1/2"	50	0,25 €
3/4"	50	0,39 €
1"	50	0,43 €
1 1/4"	50	0,49 €
1 1/2"	50	0,52 €

ARANDELA LATON



MEDIDA	UNIDAD	PRECIO
3/8"	25	0,48 €
1/2"	25	0,61 €
3/4"	25	0,71 €
1"	25	0,80 €
1 1/4"	25	2,36 €
1 1/2"	25	2,49 €
2"	25	3,25 €

SOLETA GOMA

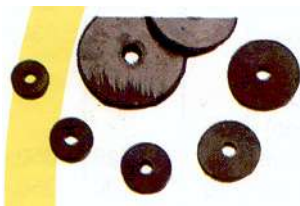

GRIFO		
MEDIDA	UNIDAD	PRECIO
12 mm	100	0,07 €
13 mm	100	0,07 €
14 mm	100	0,07 €
16 mm	100	0,08 €
17 mm	100	0,08 €
18 mm	100	0,08 €
22 mm	100	0,10 €
25 mm	100	0,10 €

CIEGA		
MEDIDA	UNIDAD	PRECIO
12 mm	100	0,07 €
13 mm	100	0,07 €
14 mm	100	0,07 €
16 mm	100	0,08 €
17 mm	100	0,08 €
18 mm	100	0,08 €
22 mm	100	0,10 €

JUNTA LATIGUILLO



MEDIDA	UNIDAD	PRECIO/100
3/8"	100	7,92 €
1/2"	100	8,08 €
3/4"	100	8,50 €
1"	100	9,77 €
1 1/4"	100	11,25 €
1 1/2"	100	12,32 €
2"	100	13,80 €

VALVULITAS



MEDIDA	UNIDAD	PRECIO
13	25	0,60 €
15	25	0,62 €
17	25	0,65 €
20	25	0,88 €

CAJA SURTIDO JUNTAS TORICAS



UN.	MED.	UN.	MED.	UN.	MED.
150	4 x 8 x 2	100	8 x 12 x 2	30	12 x 19 x 3,5
150	5 x 9 x 2	100	9 x 13 x 2	40	14 x 19 x 2,5
150	6 x 10 x 2	50	10 x 16 x 3	30	10 x 19 x 4,5
150	6 x 11 x 2,5	50	10,77 x 16 x 2,62	25	16 x 24 x 4
150	7 x 11 x 2	50	11 x 16 2,5	25	18 x 24 x 3
100	7,5 x 12,5 x 2,5	40	12 x 18 x 3	20	22 x 29 x 3,5

ENVASE	PRECIO
1	97,22 €

JUNTAS TORICAS



ARTICULO	85-01	85-02	85-03	85-04	85-05	85-06	85-07	85-08	85-09
MEDIDA	AN-1 2,9 x 1,78	AN-2 3,6 x 1,78	AN-3 4,47 x 1,78	AN-4 5,28 x 1,78	AN-5 6,07 x 1,78	AN-6 7,65 x 1,78	AN-7 9,25 x 1,78	AN-8 9,19 x 2,62	AN-9 10,11 x 2,62
UNIDADES	100	100	100	100	100	100	100	100	100
PRECIO	0,08 €	0,08 €	0,08 €	0,10 €	0,10 €	0,10 €	0,12 €	0,12 €	0,13 €

JUNTAS TORICAS



ARTICULO	85-10	85-11	85-12	85-13	85-14	85-15	85-16	85-17	85-18
MEDIDA	AN-10 12,37 x 2,62	AN-11 13,94 x 2,62	AN-12 15,54 x 2,62	AN-13 17,12 x 2,62	AN-14 18,72 x 2,62	AN-15 18,64 x 3,53	AN-16 20,22 x 3,53	AN-17 21,82 x 3,53	AN-18 23,39 x 3,53
UNIDADES	100	100	100	100	100	100	100	100	100
PRECIO	0,15 €	0,17 €	0,18 €	0,20 €	0,22 €	0,22 €	0,25 €	0,27 €	0,28 €

Caja Surtido Arandelas Planas



Uns.	Med.	DIN	Uns.	Med.	DIN	Uns.	Med.	DIN
100	8 x 12	1/4	50	12 x 19	1/2	40	16 x 24	3/4
100	8 x 15	3/8	50	13 x 18	1/2	30	18 x 23	3/4
100	10 x 14	3/8	40	13 x 24	3/4	30	20 x 30	1
90	10 x 15	3/8	50	14 x 18	1/2	30	22 x 27	7/8
40	10 x 19	1/2	40	14 x 20	5/8	30	23 x 39	1
50	11 x 18	1/2	40	16 x 22	3/4	15	32 x 38	1 1/4

MATERIAL	ENVASE	PRECIO
Goma	1	111,65 €
Klingerit	1	89,77 €

JUNTAS GOMA RACOR 2 PIEZAS



MEDIDA	ENVASE	PRECIO
3/8 - 14x11	50	0,07 €
1/2 - 18x14	50	0,08 €
3/4 - 24x19	50	0,08 €
1 - 30x25	50	0,12 €

Nº 128

JUNTAS PLANAS DE GRIFERIA

CAUCHO		
REFERENCIA	Ø	PRECIO
0114006011	8 x 12	0,17 €
0114006021	8 x 14,5	0,17 €
0114006031	10 x 14	0,17 €
0114006041	10 x 15	0,17 €
0114006051	10 x 19	0,17 €
0114006061	11 x 18	0,18 €
0114006081	12 x 18	0,18 €
0114006091	13 x 18	0,17 €
0114006101	13 x 24	0,20 €
0114006111	14 x 18	0,17 €
0114006141	16 x 24	0,22 €
0114006151	18 x 23	0,20 €
0114006161	22 x 27	0,23 €
0114006211	32 x 38	0,38 €



KLINGERIT		
REFERENCIA	Ø	PRECIO
0114006014	8 x 12	0,17 €
0114006024	8 x 14,5	0,17 €
0114006034	10 x 14	0,17 €
0114006044	10 x 15	0,17 €
0114006054	10 x 19	0,17 €
0114006064	11 x 18	0,18 €
0114006084	12 x 18	0,18 €
0114006094	13 x 18	0,17 €
0114006104	13 x 24	0,20 €
0114006114	14 x 18	0,17 €
0114006144	16 x 24	0,22 €
0114006154	18 x 23	0,20 €
0114006164	22 x 27	0,23 €
0114006214	32 x 38	0,38 €

JUNTAS DESCARGAS Y CISTERNAS

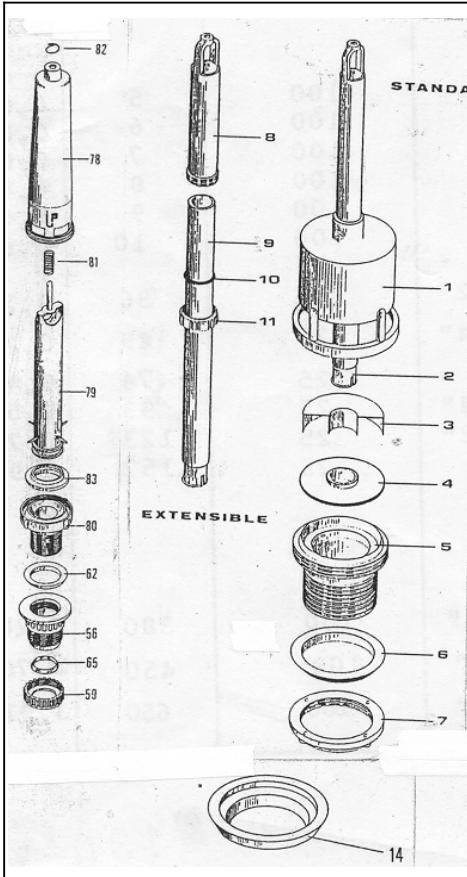

MODELO	ENVASE	PRECIO
GOMA CIERRE ALTA R-83	25	1,02 €
GOMA CIERRE DESCARGA R-4	25	0,85 €
GOMA CIERRE GRIFO FLOTADOR R-27	25	0,78 €
GOMA ACOPL. CISTERNA AL INODORO TANQUE BAJO R-14	25	2,08 €
GOMA ACOPL. CISTERNA AL INODORO TANQUE ROCA 110x95	25	1,58 €
GOMA ACOPL. CISTERNA AL INODORO TANQUE BAJO ESPUMA R-13	25	1,66 €



R - 83



R - 4



JUNTA ROCA



R - 27



R - 14



R - 13

OBTURADORES



FOMINAYA

ENVASE	PRECIO
25	0,85 €



VICTORIA

ENVASE	PRECIO
25	0,98 €



LUCERNA

ENVASE	PRECIO
25	0,85 €



ROCA

MEDIDA	ENVASE	PRECIO
R-14	25	0,85 €
R-18	25	0,85 €
R-40	25	0,85 €



FOMINAYA - CAPRI

ENVASE	PRECIO
25	0,85 €



IDROLS T/B INTERRUPIBLE

ENVASE	PRECIO
10	4,28 €



JUNTA DESAGUE T-4

ENVASE	PRECIO
25	0,38 €

Llave de corte 1/2" 3/8", filtro inoxidable, disponible en rojo y azul
10 AÑOS DE GARANTIA
CIERRE CERAMICO



DROP

CODIGOS	UN	PRECIO
XLLCDROA	12	6,10 €
XLLCDROR	100	5,63 €

Llave de corte 1/2" 3/8"

CIERRE CERAMICO



DECO

CODIGO	UN	PRECIO
440901510	12	7,85 €
	54	7,20 €



VÁLVULA ANGULAR DE CORTE
CIERRE CERÁMICO

C-850

C. ARTUCHO CERÁMICO



1. CARACTERÍSTICAS:

- PN-16
- TEMP. MAX. 150°C
- Todas las superficies interiores que están en contacto continuo con el agua son resistentes a la Corrosión
- 1/4 de vuelta
- Anti Cal
- Mando Metálico

2. MATERIALES:

- Cuerpo: Latón CW617N, según UNE-EN 12165
- Ejes y bujías: Latón CW614N, según UNE-EN 12164
- Cierre cerámico

UN	PRECIO
12	5,30 €
100	4,98 €

VALVULA ESCUADRA SIN TUERCA

1/4 DE VUELTA / DOBLE JUNTA TORICA / PN 16 Kg cm2.



CODIGO	116-08		116-12
MEDIDA	1/2 - 3/8		1/2 - 1/2
CANTIDAD	15	120	12
PRECIO	2,75 €	2,55 €	3,19 €

VALVULA ESCUADRA LARGA SIN TUERCA

1/4 DE VUELTA / DOBLE JUNTA TORICA / PN 16 Kg cm2.



Longitudes

Total: 85 mm
Entre tomas: 45 mm

CODIGO	116-14	
MEDIDA	1/2 - 3/8	
CANTIDAD	12	100
PRECIO	3,90 €	3,62 €

LLAVE AMPLIACION H3/8" – M3/8" - M3/4"

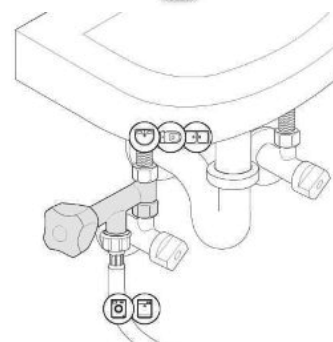

REFERENCIA	49024
CANTIDAD	5
PRECIO	15,71 €

VALVULA ESCUADRA CON TUERCA

1/4 DE VUELTA / DOBLE JUNTA TORICA / PN 16 Kg cm2.



CODIGO	116-22
MEDIDA	1/2 - 1/2
CANTIDAD	12
PRECIO	3,58 €

VALVULA ESCUADRA CON FILTRO SIN TUERCA

1/4 DE VUELTA / DOBLE JUNTA TORICA / PN 16 Kg cm2.



CANTIDAD	PRECIO
12	3,38 €
100	3,19 €

116-28

GRIFO COMBINADO LAVADORA + LLAVE REG.



1V.05800

CANTIDAD	PRECIO
6	9,84 €
12	9,45 €
24	8,85 €

No 131



Válvula conexión caldera "AGUA"

Código	Descripción	UN	PRECIO / Ud.
7846120000	M 1/2" - H 1/2" tuerca loca	12	5,96 €



Válvula conexión caldera "CALEFACCION"

Código	Descripción	UN	PRECIO / Ud.
7846340000	M 3/4" - H 3/4" tuerca loca	10	8,24 €



Válvula recta conexión caldera "AGUA"

Código	Descripción	UN	PRECIO / Ud.
7845120000	Recta M 1/2" - H 1/2" tuerca loca	12	6,34 €



Válvula recta conexión caldera "CALEFACCION"

Código	Descripción	UN	PRECIO / Ud.
7845340000	Recta M 3/4" - H 3/4" tuerca loca	10	8,60 €

Conexiones Inoxidables "extensibles" para instalaciones fijas a gas

Presión máxima 0,4 bar (Fabricado según norma UNE 60713/1)



Código	Descripción	Conexión	mm	UN	PRECIO / Ud.
5100220000	CFI Extensible H-H 1/2"	1/2" x 1/2"	200 - 340	2	10,89 €
5100300000	CFI Extensible H-H 1/2"	1/2" x 1/2"	300 - 470	2	11,98 €
5100500000	CFI Extensible H-H 1/2"	1/2" x 1/2"	500 - 850	2	15,49 €



CONEXIONES SANITARIAS

CONEXIONES SANITARIAS DE ACERO INOXIDABLE CON CABEZA NIPLE DE LATON



TIPO

M 1/2" - H 1/2"
M 1/2" - H 3/8"
M 3/8" - H 3/8"
H 1/2" - H 1/2"
H 1/2" - H 3/8"
H 3/8" - H 3/8"



MEDIDA		
cm	UN	PRECIO
10	25	1,60 €
15	25	1,63 €
20	25	1,65 €
25	25	1,75 €
30	25	1,91 €
35	25	1,99 €
40	25	2,13 €
45	25	2,48 €
50	25	2,57 €

JUEGO LATIGUILLOS MONOBLOC

MEDIDA		
Nº	UN	PRECIO
9 30 cm	12	7,52 €
10 30 cm	12	7,52 €
10 40 cm	12	7,94 €



CONEXIONES CALENTADOR

MEDIDA	UN	PRECIO
M 1/2" H 1/2" 25 cm	12	6,09 €
M 1/2" H 1/2" 30 cm	12	6,17 €
M 1/2" H 1/2" 35 cm	12	6,47 €
M 1/2" H 1/2" 40 cm	12	6,85 €
M 1/2" H 1/2" 50 cm	12	7,53 €
M 1/2" H 1/2" 60 cm	12	10,83 €

MEDIDA	UN	PRECIO
M 1/2" H 3/4" 20 cm	12	7,26 €
M 1/2" H 3/4" 25 cm	12	7,38 €
M 1/2" H 3/4" 30 cm	12	7,51 €
M 1/2" H 3/4" 35 cm	12	7,88 €

MEDIDA	UN	PRECIO
M 3/4" H 3/4" 30 cm	12	7,51 €
M 3/4" H 3/4" 35 cm	12	7,88 €
M 3/4" H 3/4" 40 cm	12	8,13 €
M 3/4" H 3/4" 45 cm	12	8,94 €

CONEXIONES ESPECIALES BATERIA CONTADOR

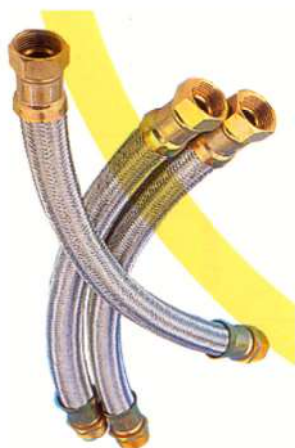

MEDIDA	UN	PRECIO
M 3/4" H 3/4" 35 cm	10	10,19 €
M 3/4" H 3/4" 45 cm	10	10,82 €
M 3/4" H 3/4" 60 cm	10	13,78 €

MEDIDA	UN	PRECIO
H 3/4" H 3/4" 35 cm	10	10,17 €
H 3/4" H 3/4" 45 cm	10	11,49 €
H 3/4" H 3/4" 60 cm	10	13,78 €

CONEXIONES INOX MOTOR AGUA

MEDIDA	UN	PRECIO
M 1" H 1" 40 cm	10	22,01 €
H 1" H 1" 60 cm	10	27,89 €



**DESCARGADOR DE TANQUE ALTO C/BASE
PARA CISTERNAS DE PORCELANA O PLASTICO**

50.A560.00

ENVASE	PRECIO		
A/560	DESCARGADOR STANDARD	10	6,14 €



70.0086.00

PRECIO	
PALANCA NORMAL	1,85 €
PALANCA REFORZADA Soporte latón	3,32 €

300031

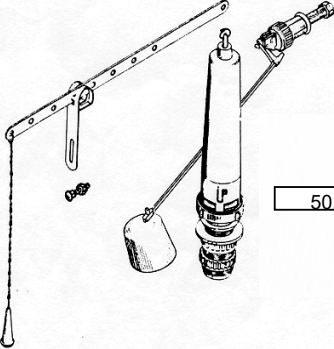

**EQUIPO COMPLETO PARA CISTERNAS ALTAS DE
PORCELANA O PLASTICO**

50.A210.00

ENVASE	PRECIO		
A/210	MEC. EQUIPO COMPLETO STANDARD	10	16,09 €



**DESCARGADOR CISTERNA
ALTA
TIPO FOMINAYA**

50.P160.00

CODIGO	ENVASE	PRECIO
0781002321	10	3,95 €



BAJANTE CISTERNA ALTA

50.P160.00

ENVASE	PRECIO
12	7,22 €

**Ahorro de hasta
de agua al día 6L***



DOBLE ENTRADA

BOYA con casco protector

ENTRADA LATERAL O INFERIOR

AHORRO DE AGUA

RETARDADO

DOBLO

**GRIFO FLOTADOR SERVO-VALVULA
LATERAL // INFERIOR**

UN	PRECIO
10	17,18 €

Nuevo

Preocupado por el ahorro de agua, Vortolan FRO mejora su gama de grifos flotadores añadiendo una nueva tecnología de **FLOTADOR INGENIEROSO**.

RETARDADO

El **FLOTADOR INGENIEROSO** permite el llenado retardado de la cisterna. Gracias a su tecnología, el flotador funciona una vez que la cisterna está completamente vacía y el mecanismo de descarga cerrado.



RETARDADO

LENADO

AHORRO DE AGUA 6L

* Ahorro de hasta 6L al día sobre cualquier modelo de flotador de la gama FRO. El ahorro depende de la configuración de llenado y de descarga de la cisterna de servicio. Ver el manual.

17/10/2022

GRIFOS FLOTADORES

GRIFO FLOTADOR SERVO-VALVULA SILENCIOSO COMPACTO



Materiales: Cuerpo de acetil, salida de poliestireno: servo-válvula de caucho.

Silencioso: 13 db a 3 bar.
Rápido: Reemplazamiento de 9 litros en 56 segundos.
Antiarriete: Incorpora filtro, fácilmente accesible para su limpieza.
Cumple con la norma NF.

0746002028



ENTRADA	UN	PRECIO
F90IN INFERIOR	6	16,53 €
F90 LATERAL	6	14,71 €

0746002009

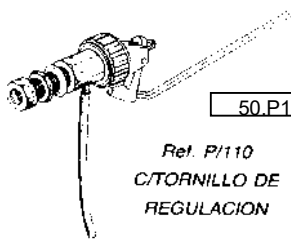

50.P110.00

Ref. P/110
C/TORNILLO DE REGULACION

P-110

GRIFO FLOTADOR 3/8" SILENCIOSO LATERAL con Boya Campana

ADAPTABLE A MODELOS: LORENTINA, CONCRETO, AUCARIA.



UN	PRECIO
12	5,87 €

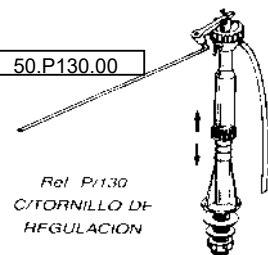

50.P130.00

Ref. P/130
C/TORNILLO DE REGULACION

P-130

GRIFO FLOTADOR 3/8" SILENCIOSO EXTENSIBLE INFERIOR con Boya Campana

ADAPTABLE A TODOS LOS MODELOS

UN	PRECIO
12	8,19 €

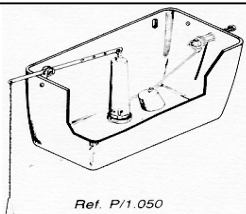

Ref. P/1.050

CISTERNA ALTA COMPLETA STANDARD P/1050

REFERENCIA	UN	PRECIO
50.1050.00	12	27,25 €

Capacidad: 10 litros
Grifo flotador silencioso 3/8"
Mecanismo descarga A/560
Tirador de cadena con pomo plástico
Unidad de envase: 12 cisternas en caja.



NOVEDAD
FLOTADOR SERVO-VALVULA LATERAL
TOPY: EL FLOTADOR MAS PEQUEÑO DEL MERCADO CON CABEZAL GIRATORIO

Características:
- Alimentación lateral
- Cabezal giratorio.
- Llave de regulación de nivel del agua.
- Universal.
- Entrada de 3/8" en latón.
- Tamaño reducido.
- Presión de funcionamiento de 1 a 16 baros.
- Capacidad almacenamiento de 20 litros.

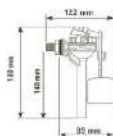

0746006653

Grifo Flotador Servo TOPY Compacto

UN	PRECIO
10	11,06 €

GRIFO FLOTADOR SILENCIOSO DE 3/8"



CIERRE ANTICORROSIVO

REFERENCIA	UN	PRECIO
240-90	12	4,55 €
80		4,00 €

GRIFO FLOTADOR CAZOLETA DE 3/8"



REFERENCIA	UN	PRECIO
240-87	12	3,98 €

BOYA ESPUMA DE 3/8"

REFERENCIA	UN	PRECIO
240-94	12	1,15 €

DESCARGADORES

**SIN CORTAR!
SIN ERROR!
FÁCIL Y RÁPIDO**

NOVEDAD! MECANISMO DE DOBLE PULSADOR

MW2: MECANISMO ECONOMIZADOR DE AGUA CON CABLE DE NUEVA GENERACIÓN

EXCLUSIVO REBOSADERO ACORDEON WIRQUIN:
Permite regular a su antojo y necesidad la altura del rebosadero. Venirás aún más perfeccionadas con el nuevo rebosadero.

Inteligente: el nuevo MW2 es el producto más compacto y más soportable en las cerámicas de reducido tamaño e incluye un exclusivo rebosadero.

El cable: compensa cualquier desajuste entre el orificio de la tapa y la sistema. Ofrece la posibilidad de levantar la tapa sin necesidad de desmontarlo. Permite colocar el pulsador en la tapa en frontal o en lateral.

Rapidez: montaje en 2 tiempos, 3 movimientos. Listo al 100% para usar.

Nueva generación de juntas de silicona: diseñadas para una mejor adaptación. El pulsador se puede colocar o encastrar según el diámetro de agujero de la tapa. Se puede instalar en cualquier sistema del mercado.

Fiabilidad: probado en + de 200.000 ciclos (equivalente a un uso de 35 años por 4 personas).

Economía: hasta 40.000l de agua economizada por año (por una familia de 4 personas).

07946002195	UN	PRECIO
	6	27,62 €

TIFON

Pulsador: Descarga completa o media descarga. Un mecanismo universal con pulsador adaptado a todos los modelos.

Garantizado por 5 años, excepto las partes de caucho.

CODIGO	MODELO	PRECIO
0386101304	SIN BASE	11,19 €
0386101267	CON BASE	13,39 €

BASE DESCARGADOR

CODIGO	PRECIO
0386100208	1,15 €

BASE DESCARGADOR CON JUNTA

CODIGO	PRECIO
0386100208K	2,75 €

**SIN CORTAR!
SIN ERROR!
FÁCIL Y RÁPIDO**

NOVEDAD! MECANISMO DE DOBLE PULSADOR

MVB3: MECANISMO ECONOMIZADOR DE AGUA CON BLOQUEO DE TAPA

ANTIVANDALICO

CODIGO	UN	PRECIO
546650	6	29,10 €

A-500

DESCARGADOR EXTENSIBLE CON BASE

ADAPTABLE A MODELOS

UNIVERSAL, DOMO, GRANADA, ITALICA, PORSAN NOA, PROA, ALMINA

PORCELANA ITALIANA, HIFI, CADORE, BRENTA, FLORALE, ENDURANCE, ALEXANDRA, REGINA

CODIGO	ENVASE	PRECIO
50.A500.00	10	6,00 €



Mecanismo compacto SOFTouch Pulsación ULTRASENSIBLE

CODIGO	ENVASE	PRECIO
50.JVS.R	6	44,67 €

TODO EN UNO

- PULSADOR ULTRASENSIBLE / SOFTOUCH MULTIPOSICIONAL
- MECANISMO COMPACTO
- GRIFO Y DESCARGA
- ENTRADA LATERAL E INFERIOR
- FÁCIL MONTAJE Y REGULACIÓN
- MONTAJE UNIVERSAL Y
- ADAPTABLE A ROCA
- SILENCIOSO
- AHORRO DE AGUA 40.000 LITROS

NOVEDADES

TYFON 3G

click

click

click

BASE ROCA*

BASE FOMINAYA

STOP

click

click

BASE GRIS ROCA*

BASE BLANCA ROCA*

TYFON 3G

**VALIDO
TODO
ROCA**

UN	PRECIO
6	13,65 €
25	13,12 €

CAJA →

click

NUEVA INSTALACIÓN

INNOVACIÓN

¡LA REVOLUCIÓN EN EL SELLADO DE ROSCAS!

GRIFTON

PRODUCTO ÚNICO: >180° AJUSTABLE POSTERIORMENTE

Kolmat® Fibre Seal es único cuando se trata de ajustar posteriormente las uniones roscadas. Sin peligro de fugas es posible montar un empalme, unión o grifo en la posición justa. Incluso al volver a girar la mitad más de 180° la unión se mantiene 100% sellada.

APLICACIÓN UNIVERSAL

Kolmat® Fibre Seal es de aplicación universal y apto para agua (potable), vapor, gas, GLP, glicol, aire (a presión) y bases y ácidos diluidos. La cinta de sellado impregnada y reforzada con fibras resiste una presión de hasta 26 bares, temperaturas de hasta 160°C. Además las uniones selladas pueden soportar cargas directamente tras aplicación de sellado.

FÁCIL, LIMPIO Y RÁPIDO

Ø PULGADAS	Ø METROS
1/2	2,3
3/4	2,5
1	3,2
1 1/4	4,5
1 1/2	4,5
1 3/4	5,4
2	5,4
2 1/4	6,7
3	6,7
4	7,4
6	7,4

KOLMAT® FIBRE SEAL

PARA UNIONES ROSCADAS METÁLICAS Y SINTÉTICAS

¡LA REVOLUCIÓN EN EL SELLADO DE ROSCAS!

UN	PRECIO
6	5,79 €
30	5,50 €

CAJA →

La REVOLUCIÓN en RENOVACIÓN

Se acabó
desmontar
la cisterna



MECANISMO QUICK FIT

CAJA

UN	PRECIO
6	26,17 €
12	5 %

EJEMPLO: SUSTITUCIÓN DE MECANISMOS CON BASE ALTA

1/ Desmontar el mecanismo antiguo, dejando la base colocada e introducir la pinza por el centro de la base dejándola en esta posición. Desenroscar la base.

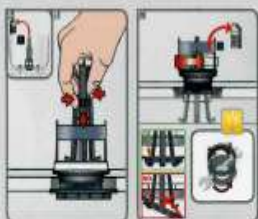

2/ Secar **totalmente** el fondo de la cisterna e introducir la base. Tirar hacia arriba de la pinza hasta que la rosca interior quede sujeta en los anclajes rojos.



3/ Quitar la pinza y realizar una presión uniforme sobre la base con la ayuda de un paño.



4/ Colocar el cuerpo del mecanismo e instalar el pulsador.



- ▶ Gracias a su base patentada, el QUICK FIT se adapta a cualquier configuración sin necesidad de quitar la cisterna.
- ▶ Revolucionario sistema para una instalación óptima, rápida y segura.
- ▶ Producto pensado para el profesional.



Exclusividad **PATENTADA**
Anclaje universal desde el interior de la cisterna



VIDEOS DE MONTAJE
en distintas situaciones



No 135 03

¡4a Pj b!

WC TRONIC 2

Suministros
FONTANA, S.L.
EXCLUSIVIDAD

WIRQUIN

DESCARGADOR WC HIGIÉNICO SIN CONTACTO

oF67M3L936I L A N xnhg W 2 5I H M HML 67 B H 3 L U D M 7 M O H J U 6 O 5 N
K O 7 9 3 L 3 H N B B B M S I M B G L E I D P D 7 H 7 F B H I 6 I U A

j F 6 7 M 3 L 9 3 L , 6 7 B G I M P B L O M 4 3 5 N V L B M T 9 L G 7 H 7 M 6 7 H O 7 M L 3 J B 7 F 7 H 7 F J O R 3 6 I L A
m l H 7 F A N x n h g W 2 B 6 7 M 3 L 9 3 M L 7 3 F L B M H 5 I H N 5 N 9 L 3 5 B M B F M H M L 7 P B B H 6 I
B N 3 H M G B B H 6 7 3 9 7 H N M I 3 N 9 7 H I M 7 H N L 7 B M 7 L M H 3 M A

7 5 I G 7 H 6 3 6 I J 3 L 3 @ N F 7 M I 8 5 B H 3 M 7 M O 7 B M L 7 M 5 7 H 5 B M @ M B B F M @ 9 3 L 7 M V A

¡SIN CONTACTO!



4t Uka Wb!
Ot %o yo % r (or(o)o



4a gi Uj b!
Ot(trri i uo ...%



4f La Pf Ri Penb!
R ri orri o it (o o (s % i % t % o % o 2 t % t % o % r s i % o o r i s o s B



4Nb ageb VOPV
Nbafi Z b O P L Si L!
D% tsjost %o yo F%st %o yor t(o



4evc W L U f g L V L N U a!
N o(i p t r (s % % tro i % %st eb NL 3 % st % (o ori %t o



j 57L53L B G 3HI
3 OHI M57HNG 7NI M
67 B 5 FO B 3UOFT B
67M3L93 M 35N3A

7N3L3 B G 3HI T B
67M3L93 M J 3L3A

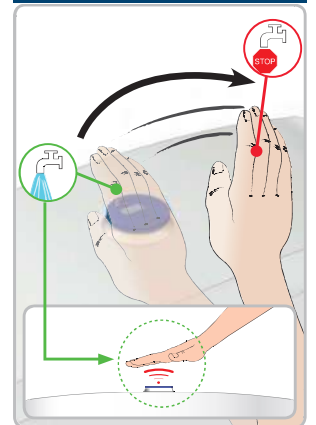

wirquin PRO

EXPERTO EN EQUIPAMIENTO SANITARIO

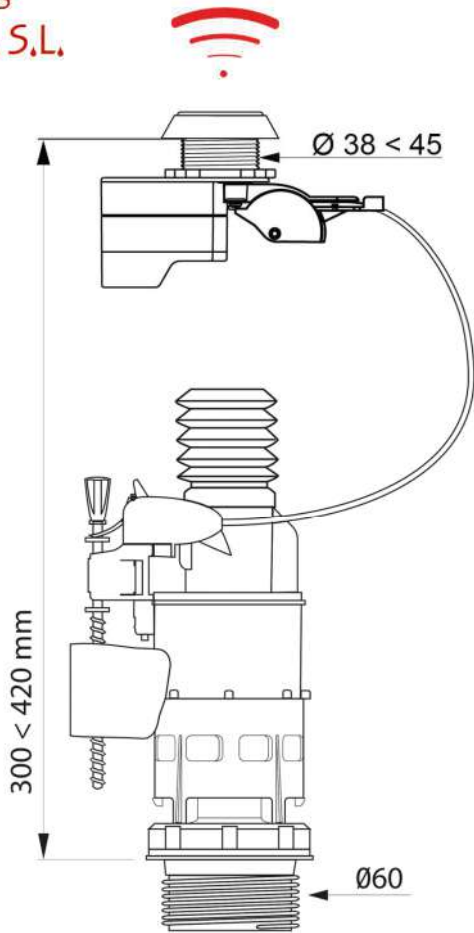

Nb Z cLgUWP Nb a gb OL f VL f ML f Pf
OP eb NL 3 cLeL i aL lã fgl VL NU a flã
OPfZ ba gl e VL NU gPea L

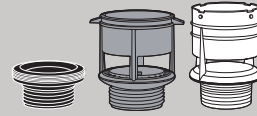

► f P L O L c g L L V f U g P Z L
ge L O U N U b a L V O P eb NL 3

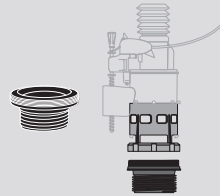

► f P L O L c g L L V f U g P Z L
ai P j b O P eb NL 3

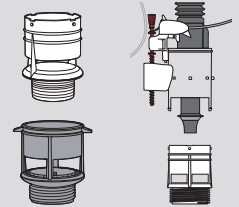

R) r i or G i o % ã e H, i r) i s o % ã
t % ã t o o . i % ã t i . t s t p o (t o t % p o ...
, t t s ... t o t r t 6 ... 1 A

NL e L NgPe ff gU N L f gxNa U N L f

ORnNrM/NWg	I Ngeba W EI Z PNL a U Z b I N flã Nb a gl Ng b
nMxRe C ORa i anCOhm	Nop t
xW/h OR ORnNCrT C	N (s t r % s t o y) o D % t s j o s t % o y o F % s t % o y o r t (o
Nhe i CxW/WDCO	O F f m f g P Z I N o (i p t r (s % % t r o i % % s t e b N L 3 % s t % (o o r i % t o
hxnCn NCnCNxRmxcMcn	DCC* r t (o o) o i % o o r i) t . o e t p % s t t o (t % p t

opo oz msj	no m s ns z	m nsq...no l j j	- Cn	j muA
10723408	WC TRONIC 2: MECANISMO WC SIN CONTACTO	3375537232901	12	CAJA

PRECIO/UD
86,55 €

Universales 100%

DESCARGADOR UNIVERSAL DOBLE PULSADOR GRAN CALIDAD

DESCARGADOR UNIVERSAL INTERRUMPIBLE GRAN CALIDAD



T-280 S



UN	PRECIO
6	23,14 €
16	20,80 €



T-281 N

Con KIT

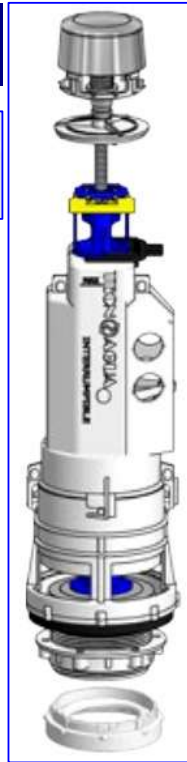

UN	PRECIO
6	16,12 €
16	15,28 €

FLOTADORES SUPER SILENCIOSOS EXTENSIBLES – FACIL REGULACION



T-461
Código: 50635

UN	PRECIO
6	13,75 €
26	12,61 €

GRIFO CISTERNA ALIMENTACION DUAL

HORIZONTAL - VERTICAL NOVEDAD

LO QUE NOS DIFERENCIA:

- Convertible en 10 segundos
- Regulación instantánea de la boya
- Fácil acceso a membrana
- Rápida regulación en altura
- Fabricado en resina acetilica (P.O.M.)
- Compacto
- Seguro



T - 469

UN	PRECIO
6	15,21 €
40	14,08 €



T-451
Código: 50634

UN	PRECIO
6	13,75 €
44	12,61 €

PULSADOR LATERAL CUADRADILLO CROMADO



ESPECIAL "ROCA"

MOD	REFERENCIA	mm	ENVASE	PRECIO / UN
PC2	0142015130	280	10	16,14 €



L/176-1

PULSADOR FRONTAL CROMADO

CODIGO	ENVASE	PRECIO
50.L176.01	6	8,47 €

Mod. LOIRA, Mod. CONCRETO, Mod. PORSAN, Mod. GRECIA



PALANCA FRONTAL DE CERAMICA CROMADA

L/176-03

CODIGO	ENVASE	PRECIO
5.L176.03	6	17,94 €



GUIA PULSADOR PARA ORIFICIO PEQUEÑO

Ø 12 a 40 mm

CODIGO	ENVASE	PRECIO
70.0260.01	12	6,77 €

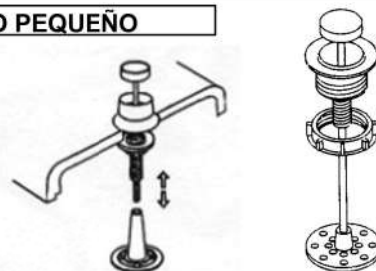

TIRADOR CADENA CISTERNA ALTA

CODIGO	MODELO	ENVASE	PRECIO
70.0215.00	ALUMINIO	25	2,14 €
781004424	ACERO	12	4,99 €



L 175

50.L175.01

UN	PRECIO
10	3,22 €

TIRADOR VERTICAL CROMADO

Ref.	Medida	Adaptable a modelos
L/175	100 mm	DIANA, PORSAN, NOA
L/175	100 mm	VICTORIA, ACUARIA
L/175	100 mm	GRANADA, CAPRI, NERJA
L/175	100 mm	ATENEA, NEPTUNO, APOLO, VENUS
L/175	100 mm	FLORIDA, FESTA, ITALICA, TURIA
L/175	120 mm	NOVO-ESPACIO, LUCERNA
L/175	120 mm	GONDOLA

L 174

50.L174.01

UN	PRECIO
10	3,22 €



BOYA SIFONICA

CODIGO	UN	PRECIO
981701	6	3,30 €

Nº 137



NOVEDAD!

CISTERNA UNIVERSAL TANQUE BAJO
Doble descarga

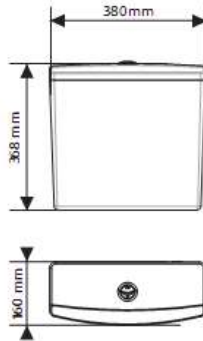

- Características:**
- Aislamientos acústico y térmico (evita la condensación).
 - Cisterna en ABS lista para usar.
 - Completa: flotador NF y mecanismo de doble descarga.

CODIGO	COLOR	UN	PRECIO
0746006714	BLANCO	1	63,86 €

CISTERNA SEMI-ALTA
Doble descarga

- Características:**
- Economizador de agua con pequeña y gran descarga.
 - Aislamientos acústico y térmico (evita la condensación).
 - Silenciosa
 - Cisterna en ABS lista para usar.
 - Completa: flotador NF y mecanismo NF.

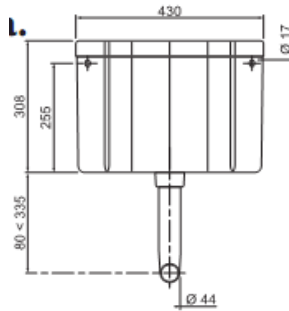

CODIGO	COLOR	UN	PRECIO
	BLANCO	1	61,91 €

Cisternas de empotrar

Conjunto completo cisterna empotrada + Pulsador Aluminio Cepillado

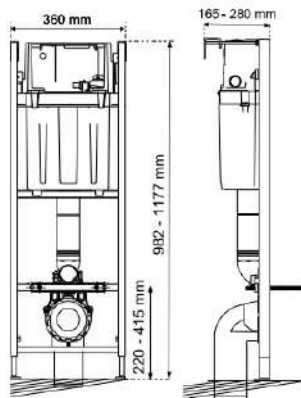

- Silencioso
- armadura ANTI CORROSIÓN
- Selección OBRAS
- Garantía 10 AÑOS

REFERENCIA	PRECIO
55950018	166,70 €

Conjunto completo cisterna empotrada DUAL con placa pulsadora

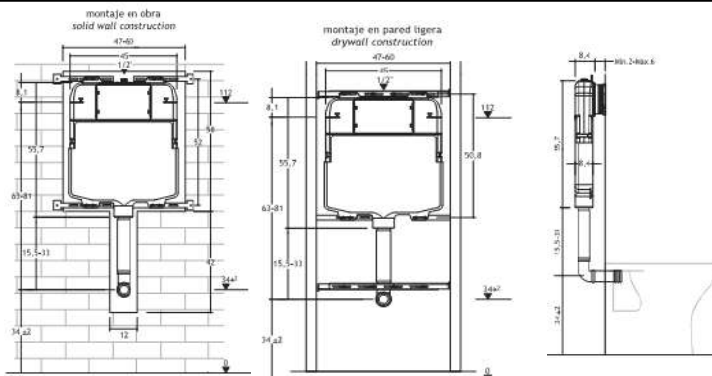

REFERENCIA	PRECIO
00679	171,34 €

S-614

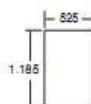

Altura	Ref.	U/	n.º	PRECIO
1.185 mm	23157	1	-	206,50 €

Módulo bidé. Espesor 135 a 200 mm.
Bastidor robusto sobre pies con fijaciones murales y pasamuros insonorizados. Con codo de evacuación (e entrada 32 - 40, e salida 40 - 50) y tornillería de fijación.

Cisterna Vista



Cisterna Vista

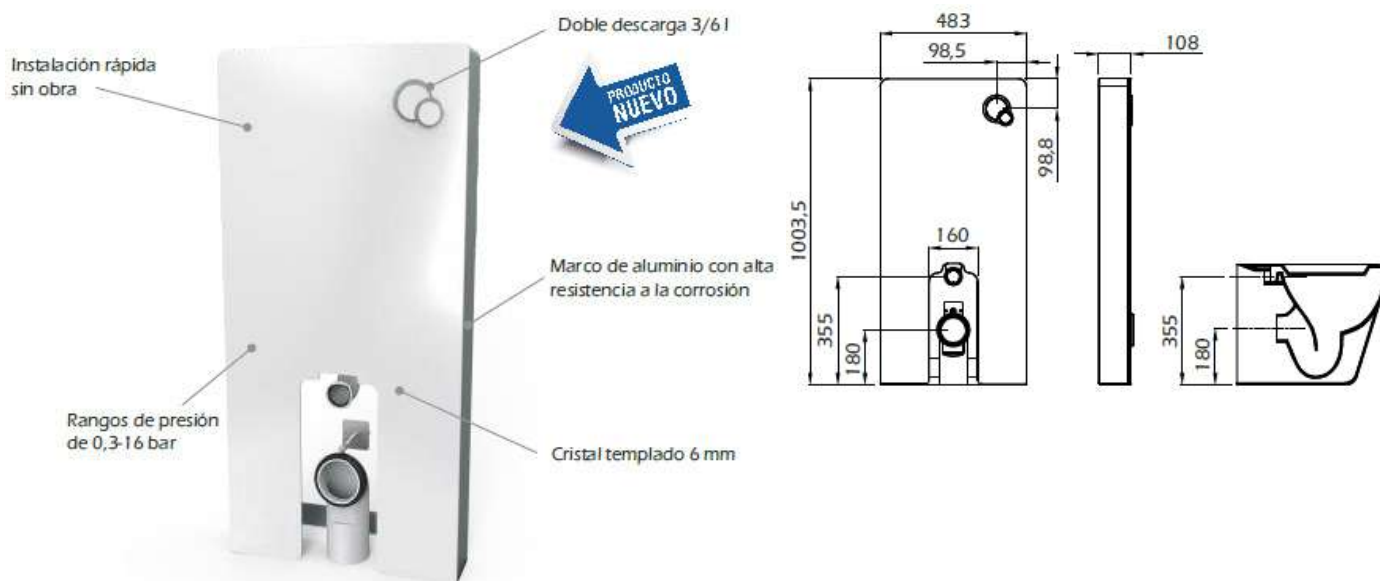

CODIGO		PRECIO
40430	Cisterna vista WHITE compacta para inodoros a suelo	354,38 €
40420	Cisterna vista BLACK compacta para inodoros a suelo	354,38 €



CODIGO		PRECIO
40410	Cisterna vista WHITE compacta para inodoros a suspendidos	389,07 €
40400	Cisterna vista BLACK compacta para inodoros suspendidos	374,38 €

SIFON FLEXIBLE PVC
RESISTENTE A PRODUCTOS QUIMICOS



		PRECIO
SIFON ABIERTO "P"	30x30	4,15 €
SIFON ABIERTO "P"	40x40	4,15 €
SIFON CERRADO "S"	30x30	5,08 €
SIFON CERRADO "S"	40x40	5,08 €

SIFON EXTENSIBLE MULTIUSO

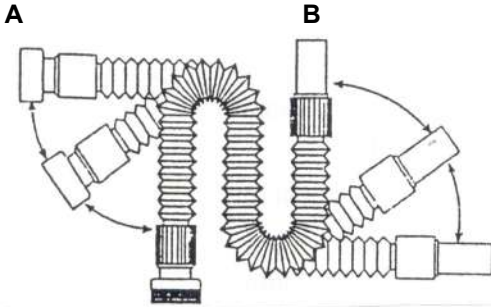

Color: Blanco
 Temperatura de empleo: 0 °C +90 °C (Max. 110 °C)
 Características: tubo en polipropilene arrugado que se puede comprimir, alargar, orientar donde interesa desaguar, de 300 mm hasta 800 mm tomando la forma deseada.
 Provisto de conexión con tuerca giratoria en latón y manguito con junta.
 Aplicación: descarga y desagüe de aguas residuales domésticas.
 Lavabos, bañeras, bidés, fregaderos, picas de lavar, etc.
 Importante: Juntar el tubo y las conexiones con cita P.T.F.E.

A	B	PRECIO
pulgadas	mm	
1 1/4"	32	9,58 €
1 1/2"	40	9,58 €
1 1/4"	40	9,58 €

A	B	PRECIO
pulgadas	mm	
1 1/2"	40	11,53 €
1 1/4"	40	11,53 €



DESAGUE SPACE



	PRECIO
1 SENO	12,12 €
2 SENOS	16,36 €

SIFON SENZO



Sifón sin guarda de agua tradicional.
 Sifón con membrana de silicona integrada, deja pasar el agua y se cierra inmediatamente para evitar el retorno de malos olores.
 Extraplano
 Estanqueidad completa gracias a la doble junta labiada con anillo de mantenimiento.
 Totalmente flexible. Se comprime sin esfuerzo, se curva a 90°.
 Funciona perfectamente tanto en vertical como en horizontal.
 Resiste 300.000 ciclos de paso de agua.
 Resistente a los productos de limpieza estandar del mercado.

MEDIDA	UN	PRECIO
1 1/4 - 32	12	15,38 €
1 1/2 - 40	12	16,36 €

CONVERSION
A 1 1/4"

Sifón Extensible

T-39D DUAL
Siempre Tuerca Loca

NOVEDAD

Ø32 Ø40

INSOLUBLE

UN	PRECIO
12	4,51 €

Quick Clac

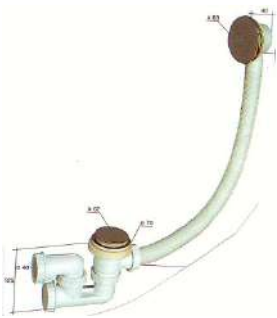

Quick Clac de Bañera con Codo de 40mm para instalaciones con bote sifónico.

0746003490

REFERENCIA	COLOR	UN	PRECIO
SP760299	CROMO	10	32,45 €



CODIGO		COLOR	UN	PRECIO
SI402C	Clic Clac Lavabo/Bidé Ø 32	CROMO	6	11,40 €
SI402BR	Clic Clac Lavabo/Bidé Ø 32	BRONCE	6	15,80 €
126XVCCUNIC	Válvula Clic Clac UNIVERSAL	CROMO	6	10,77 €



SI405C

Quick Clac Bañera latón

COLOR	UN	PRECIO
CROMO	3	50,48 €



REBOSADERO VALVULAS Quick Clack

COLOR	UN	PRECIO
CROMO	6	21,04 €



0439000206

SIFON BOTELLA Latón Cromado

Ø	UN	PRECIO
32	6	17,64 €



9660105

MILLENIUM

Ø	UN	PRECIO
32	4	28,44 €

PROLONGADOR FLEXIBLE Latón Cromo



1S.111C0

MEDIDA	UN	PRECIO
32 x 30 cm	6	9,97 €

Construidos en latón
DIN-17660 cromado

PROLONGADOR Latón Cromo



1S.111A0

MEDIDA	UN	PRECIO
32 x 30 cm	6	7,52 €

No 140

Desagües











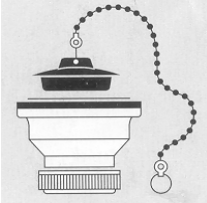

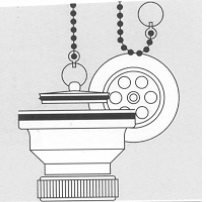

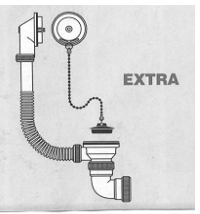

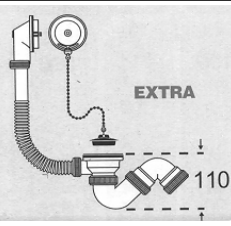

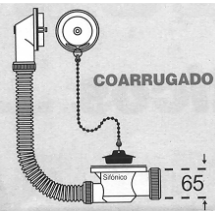

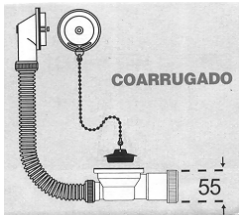

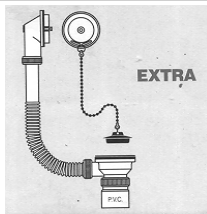



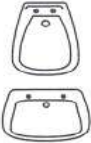

FIGURA	REF.	CODIGO	APLICACIÓN	DESCRIPCION	U/C	MED.	PRECIO
	T-61	50310		Salida Ø 32 Valvula lavabo - bide chapa inox. Ø70	60	1¼	4,43 €
		50315		Salida Ø 40	60	1½	3,29 €
	T-61-C	50401		Válvula lavabo y bidet SERIE LUJO	S/P	1½	15,40 €
	K-62-C	50405		Kit montaje para conjuntos de bañera standard	S/P	1½	17,46 €
	T-63	50505		Conjunto bañera con rebosadero Autofijante Salida orientable Ø 40 EXTRAFLEXIBLE	25	1½	10,67 €
	T-64	50510		SIFONICO Conjunto bañera con rebosadero Autofijante Salida Ø 40 EXTRAFLEXIBLE	25	1½	12,07 €
	T-64-B	50515		Conjunto bañera con rebosadero Autofijante Salida orientable Ø 40 EXTRAFLEXIBLE	25	1½	10,76 €
	T-63-B	50530		Conjunto bañera con rebosadero Autofijante Salida Ø 40 EXTRAFLEXIBLE	25	1½	12,08 €
	T-62 PVC	50450		Conjunto bañera con rebosadero Autofijante Salida vertical encolar Ø 40 EXTRAFLEXIBLE	25	1½	10,21 €
	ETP-03 PVC			Codo cota baja tuerca loca junta plana 1¼" salida mixta 32/40 (40 PVC encolable) especial válvula Click-Clack (tuerca loca)	25	1¼	2,33 €

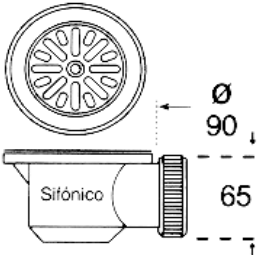
FIGURA	REF.	CODIGO	APLICACIÓN	CARACTERÍSTICAS	U/C	MED.	PRECIO	
	T-61	40440		chapa salida	Ø 70 Ø 32	S/P	1 ¼	24,10 €
	Cromo	40443		chapa salida	Ø 70 Ø 40	S/P	1 ½	24,26 €
	T-55R	50250		Sifón fregadero 1 seno Ahorro Espacio	40	1 ½	12,71 €	
	T-56R	50255		Sifón fregadero 2 senos Ahorro Espacio	20	1 ½	16,10 €	
	T-65	50520		NORMAL	75	1 ½	5,29 €	
	T-66	50525		Válvula plato ducha EXTRABAJA SIFÓNICA	60	1 ½	5,71 €	
	T-66-P	50531		REJILLA Ø 85	60	1 ½	4,55 €	
		50532		Válvula plato ducha SIFÓNICA	REJILLA Ø 115	50	1 ½	8,08 €
	T-81	50533		REJILLA Ø 85	60	1 ½	4,20 €	
		50534		Válvula plato ducha horizontal	REJILLA Ø 115	50	1 ½	7,23 €
	T-67	50320		REJILLA Ø 85	100	1 ½	4,81 €	
		50535		Válvula plato Ducha encolar Chapa inox.	REJILLA Ø 115	80	1 ½	8,38 €

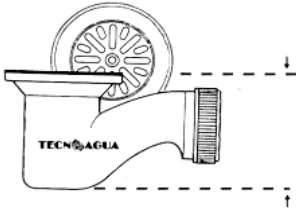
SIFONES ESPECIFICOS WIRQUIN

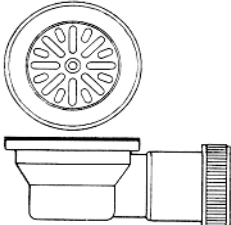
SIFON COMPACTO

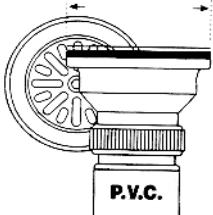

UN	PRECIO
6	10,91 €

El sifón compacto es un sifón de lavabo y bidé en elastómero termoplástico. Puede instalarse a cualquier desagüe estándar con fileteado de 1/4". Dimensiones: Longitud 186 mm, Anchura: 60 mm, Altura 88 mm. En comparación con los sifones actuales su altura está considerada reducida, lo cual permite, parte de una fácil instalación, un gran ahorro de espacio al quedar el sifón muy pegado a la parte inferior del lavabo. Otra diferencia a los sifones convencionales es que dispone de 2 cavidades de 25 mm. Cada una para guarda de agua en lugar de una sola de 50 mm. El caudal es superior a 0,7 litros/segundo, lo que es un valor superior al valor pedido por la norma francesa. En caso de obstrucción simplemente se tiene que efectuar una presión sobre el sifón para descompactar los posibles aglomerados y evacuarlos. No es necesario desmontar el sifón, de esta forma la operación es más rápida, limpia y accesible a cualquier persona. El SIFON COMPACTO es el único sifón flexible existente en el mercado.

Desagüe TOURBILLON Ø60 Cromado

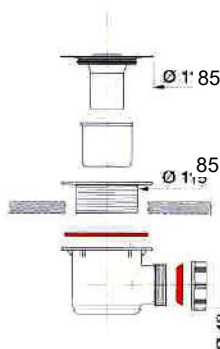

El TOURBILLON es el desagüe de Ø 90 de diseño práctico y de fácil limpieza gracias a su cesta extraíble.

Se adapta a instalaciones a bote sifónico.

Rápido: 30 litros/minuto bajo 120 mm de altura de agua.

Compacto: 100 x 85 x 70 mm (para gres) y 100 x 85 x 83 mm (para acrílico)).

Altura de sifonaje: 50 mm

Salida horizontal Ø 40 mm a enroscar o encolar.

Preparado para conectar pipeta de extracción de vapor.

Ø	UN	PRECIO
85	12	11,51 €

Desagüe TOURBILLON Ø90 Rejilla Champiñon ABS Cromado

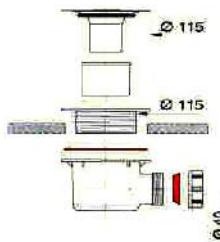

El TOURBILLON es el desagüe de Ø 90 de diseño práctico y de fácil limpieza gracias a su cesta extraíble.

Se adapta a instalaciones a bote sifónico.

Rápido: 30 litros/minuto bajo 120 mm de altura de agua. Compacto: 100 x 85 x 70 mm (para gres) y 100 x 85 x 83 mm (para acrílico)).

Altura de sifonaje: 50 mm

Salida horizontal Ø 40 mm a enroscar o encolar.

Preparado para conectar pipeta de excavación de vapor. Embellecedor champiñon en ABS cromado.

Ø	UN	PRECIO
115	12	18,36 €

DESAGUE TWISTO



UN	PRECIO
6	29,97 €

Twisto: el desagüe de ducha de Ø 90 de caudal rápido que no se deja "desbordar".

Prestaciones: Caudal muy rápido, 32 litros/minuto bajo 15 mm de altura de agua. Altura de sifonaje más de 50 mm.

Compacto: 130 x 120 x 90 mm (altura bajo el plato de ducha)

Junta encolada: no se mueve durante la instalación.

Rejilla "champiñon en latón".

Salida horizontal Ø 40 mm a enroscar o encolar.

Versión no sifónica disponible para instalación a bote sifónico. Embellecedor champiñon latón.

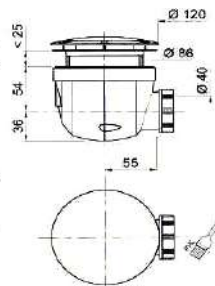

VALVULA NO SIFONICA EXTRAIBLE T-78 T

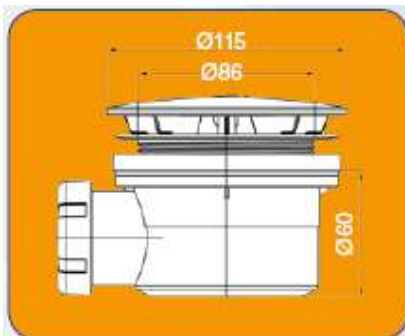

REF. T-78 T
CÓD./CODE: 50238
U/C - U/Box: 12 -

PRECIO
30,59 €

SLIM DUCHA

Sifón para plato de ducha Ø 90 EXTRA PLANO.



Vaso sifónico



PRO TECNOLOGÍA

- ▶ **Espacio reducido (58 mm)** especialmente reservado para platos de ducha Ø 90 extraplano.
- ▶ **Caudal (bajo 15 mm de agua)** superior a los criterios establecidos por la normativa.
- ▶ **Universalidad:** 2 productos para ofrecer soluciones universales de instalación.
- ▶ **Rejilla en ABS cromado** y diseño minimalista.
- ▶ **2 modelos:**
Válvula sifónica con vaso.
Válvula no sifónica con filtro y membrana antirretorno.



OFERTA

UN	PRECIO
10	28,13 €
24	26,00 €

PRO DATOS TÉCNICOS

CARACTERÍSTICAS DE PRODUCTO

SIFÓN	
Versión	
Espacio bajo plato	58 a 60 mm
Altura sifonaje	25 mm
Caudal bajo 15 mm de agua	24L/mn
Acabado	Ø 90 Rejilla Champiñón
Sección	



INSTALACIÓN EN PLATOS DE DUCHA EXTRAPLANOS O CON PERFORACIÓN CÓNICA.

NUESTRA SOLUCIÓN: UN ADAPTADOR ESPECÍFICO.

MATERIAL: POM (POLIOLEFINA)



Salida: Ø 40 a roscar o a encolar

Esquema técnico:

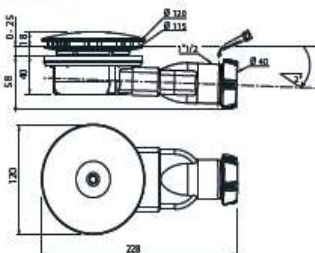

SLIM BRIDA METÁLICA | ▶ LA VÁLVULA MÁS PLANA DEL MERCADO

SLIM BRIDA METÁLICA
EXTRAPLANA, GRAN CAUDAL, FÁCIL MANTENIMIENTO



UN	PRECIO
10	30,81 €
24	29,35 €

LAS VENTAJAS DE LA VÁLVULA SLIM BRIDA METÁLICA

- ▶ Especialmente concebida para los platos extraplano y equipados con un embellecedor.
- ▶ No precisa picar el forjado y permite una instalación a ras de suelo
- ▶ Sifón con membrana de silicona: garantía 100% sin olores y sin desifonaje
- ▶ Fácil mantenimiento : acceso directo a la membrana antirretorno y antiolores y al filtro



Desagües













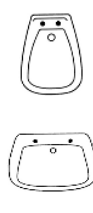

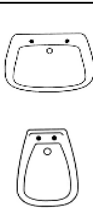

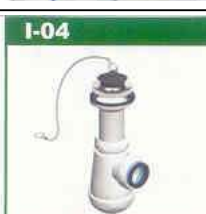
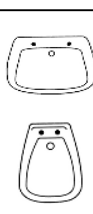

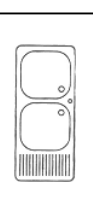

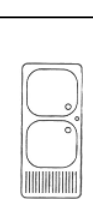

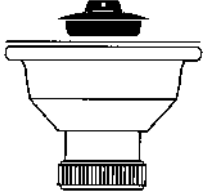

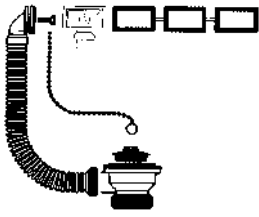

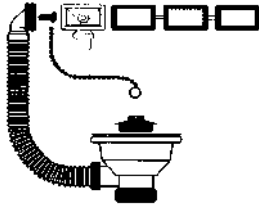

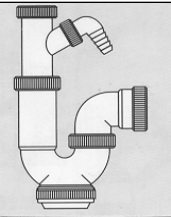

FIGURA	REF.	CODIGO	APLICACIÓN	DESCRIPCION	U/C	MED.	PRECIO
	T-8	50056		Sifón Y griega para recibir tubos lisos. Entrada Ø 40 Salida Ø 40 EXTRA CORTO	60	1½	4,60 €
	T-9	50053		Sifón Y griega Chapa Inox Ø 70 Salida Ø 40	50	1½	4,81 €
	T-4	50041		Sifón botella extensible con tuerca loca Entrada 1½ Salida Ø 40 EXTRA CORTO	60	1½	3,93 €
	T-4T	50051		Sifón botella con toma de lavadora Entrada 1½ Salida Ø 40 EXTRA CORTO	40	1½	5,27 €
	T-3	50020		Sifón botella extensible Chapa Inox Ø 70 Salida Ø 40 EXTRA CORTO	50	1½	6,04 €
	T-50	50225		Sifón doble con racord Distancia entre ejes Máximo 600 Mínimo 165 Chapa Inox Ø 40 EXTRA LARGO	30	1½	8,25 €
	T-45	50205		Sifón doble con racord Distancia entre ejes Máximo 600 Mínimo 165 Chapa Inox Ø 40	30	1½	7,27 €

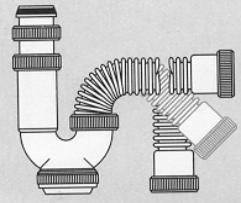
FIGURA	REF.	CODIGO	APLICACIÓN	CARACTERISTICAS	U/C	MED.	PRECIO
	T - 72	50340		Válvula cesta inox. Stainless basket valve Chapa inox./Stainless plate ø115 Salida /Outlet ø40	40	ø115	14,51 €
		50341		Chapa inox./Stainless plate ø85 Salida /Outlet ø40	40	ø85	14,51 €
	T - 73	50345		Válvula cesta inox. Stainless basket valve Chapa inox./Stainless plate ø115 Salida /Outlet ø40	60	ø115	13,56 €
		50346		Chapa inox./Stainless plate ø85 Salida /Outlet ø40	60	ø85	13,56 €
	T - 70	50335		Válvula gigante Oversized valve Chapa inox./Stainless plate ø115 Salida /Outlet ø40	35	ø115	7,48 €
	T - 68	50325		Válvula fregadero con rebosadero Kitchen sink valve with overflow chapa inox./Stainless plate ø70 Salida /Outlet ø40	50	1½	8,85 €
	T - 69	50330		Válvula gigante con rebosadero Oversized valve with overflow Chapa inox./Stainless plate ø115 Salida /Outlet ø40	35	ø115	12,35 €
	T-93	50350		Tapón válvula Plug Valve	s/p-p/o	ø115	4,70 €
		50351		Cesta inox. Stainless Basket	s/p-p/o	ø85	4,70 €
	T-93 BM	50359		Tapón válvula Plug Valve Serie Baja Cesta inox. Stainless Basket		ø115	4,81 €

Desagües

FIGURA	REF.	CODIGO	APLICACIÓN	DESCRIPCION	U/C	MED.	PRECIO
	T-31-T	50060		Sifón curvo extensible con toma lavadora	35	1½	5,32 €
	T-32-F	50061		con válvula Sifón curvo extensible salida orientable Ø40	60	1½	8,60 €
	T-33-F	50062		MULTIORIENTABLE sin válvula	60	1½	7,26 €
	MUT-01 MUT-02 MUT-03			Manguito union macho PVC para tubo metálico o plomo.			
				22-28 / 32 Ø	12		2,43 €
				22-28 / 40 Ø	12		2,43 €
				35 / 40 Ø	12		2,77 €
	MUH-01 MUH-02 MUH-03			Manguito union hembra PVC para tubo metálico o plomo.			
				22-28 / 40 Ø	12		2,26 €
				22-28 / 50 Ø	12		2,43 €
				38-40 / 40 Ø	12		2,43 €
	T-206	50830	Conexiones	Manguito reparador Hembra Ø40	150	Ø 40	1,68 €
	T-207 T-207 T-207 VA	50835 50836 50837	Conexiones	Racord Ø 32 - 1¼ Racord Ø 40 - 1½ con tuerca Ø 40 - 1¼ loca	150 150 150	Ø 32 Ø 40 Ø 40	1,62 € 1,62 € 1,62 €
	T-200 T-201 T-201	50800 50806 50805	Conexiones Conexiones Conexiones	Codo H-H Ø 40 Codo M-H Ø 32 Codo M-H Ø 40	125 125 125	Ø 40 Ø 32 Ø 40	2,34 € 1,64 € 1,64 €
	T-209-H	50841 50842	Conexiones	1¼ x 40 Conexión hembra para unir sifones a tubería PVC con tuerca loca. 1½ x 40	S/P S/P	Ø 40 Ø 40	1,60 € 1,60 €
	T-217	50855		CONVERSION INTERIOR PARA TUBO DE PVC A TUBOS LISOS	60	Ø 40	1,98 €

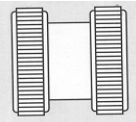
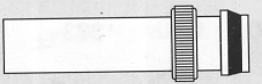
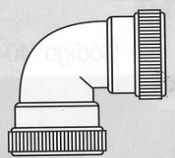
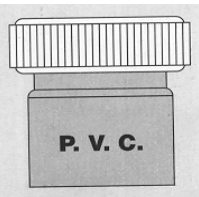

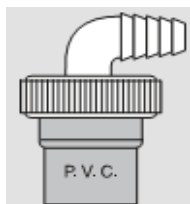
TOMA ELECTRODOMESTICOS T-210-M

Para conectar la lavadora ó lavavajillas.
Su extremo está cerrado con un tapón
(tipo dedal) para evitar olores hasta la
instalación de los aparatos.

CODIGO	PRECIO
50849	1,77 €

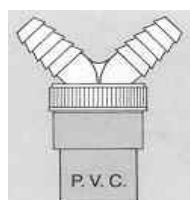

TOMA DOBLE ELECTRODOMESTICOS T-219

Para conectar la lavadora ó lavavajillas.
Sus extremos están cerrados con un tapón
(tipo dedal) para evitar olores hasta la
instalación de los aparatos.

CODIGO	PRECIO
50804	2,83 €

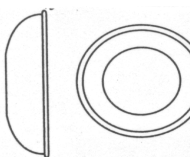

PLAFON EMBELLECEDOR C-161

CODIGO	MEDIDAS	PRECIO
0439002262	1 1/4" - 40	0,63 €
0439002293	1" - 32	0,63 €

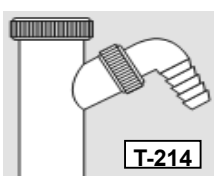

CONEXIÓN CON TOMA LAVADORA

CODIGO	MODELO	MEDIDAS	PRECIO
50862	T-214	40	3,26 €
50803	T-218	40	3,26 €

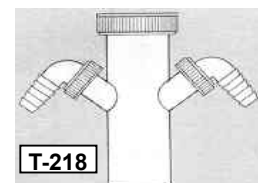

TUERCA VALVULA C-185

CODIGO	Ø	UN.	PRECIO / Ud.
S0398	1 1/4	12	0,68 €
S0397	1 1/2	12	0,69 €

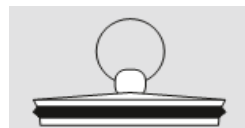

TAPON LATON CROMO 1 1/2

CODIGO	UN	PRECIO
50415	12	7,22 €

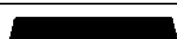

JUNTA CONICA C-191

CODIGO	Ø	UN.	PRECIO / Ud.
50936	1 1/4	12	0,39 €
50937	1 1/2	12	0,39 €



Junta para manguito
union tubo metalico.
A-46 Ø 40 / 32

UN	PRECIO
25	1,66 €



**JUNTA PLANA
T-512**
Para desagües T-61

UN	PRECIO
25	0,60 €



**JUNTA BASE
LABIADA T-513**
Para desagües T-61

UN	PRECIO
25	1,17 €



MAGICCOUDE: La solución rápida y practica.Fácil y muy rápido de montaje. Resistente.
A encolar.El MAGICCOUDE es un racor de evacuación articulado hembra-hembra, que
se constituye de una zona acordeón que se puede deformar, y que está reforzado en sus
extremidades por unos regatones de PVC rectos.No sólo permite unir dos tuberías que
formen un ángulo entre 0° y 120°, sino que también permite realizar una unión entre dos
tubos desplazados.Sustituye ventajosamente los racores de evacuación en PVC recto ya
que para un diámetro dado, una única referencia se adapta a todas las configuraciones.
Existe en Ø 32 RT32000, Ø 40 RT40000 y Ø 50 RT50000.
No necesita ningún cálculo de ángulo.Resiste los agentes detergente actualmente
comercializados y también los productos desatascadores a base de ácidos clorhídricos o
sulfúricos.
Resiste una temperatura de entre 0° y 95°.

CODIGO	Ø	PRECIO
0746002545	32	5,19 €
0746002559	40	5,19 €
0746002560	50	7,11 €
0746000595	110	48,60 €



Quick Clac



PRECIO
8,00 €

- **KIT TOTALMENTE MONTADO**
- **RÁPIDA INSTALACIÓN**
- **MONTAJE SIN COMPLICACIONES**

T - 2M Clack



Código: 50109 - 1½

PRECIO
12,01 €

T - 60 Clack



Código: 50110 - 1½

PRECIO
9,39 €



PRECIO
50,17 €

T-120 XL

Mang. Inodoro Acortable PVC (650-160)
Shortenable pan connector

Código: 50706



PRECIO
56,27 €

439001524

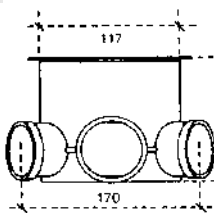
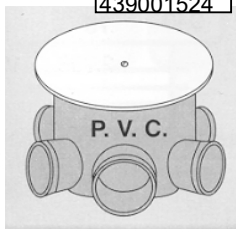
**BOTE SIFONICO CIEGO**

Bote sifónico en PVC con tapa de expansión y embellecedor inox. 5 entradas de 40 Ø y salida de 50 Ø.

UNIDADES	PRECIO
10	7,48 €
20	6,73 €

439001531

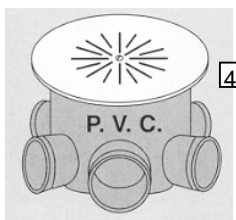
**BOTE SIFONICO REJILLA**

UNIDADES	PRECIO
10	8,67 €
20	7,86 €

EXTRABAJO
EXTRA-LOW

50607

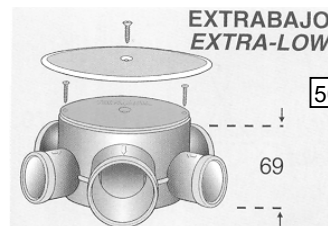
**BOTE SIFONICO EXTRABAJO**

UNIDADES	PRECIO
6	7,40 €
1 CAJA	7,13 €

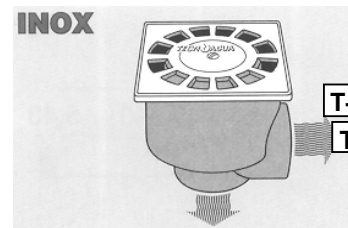
INOX

T-87 INOX

T-87 PVC

SUMIDERO BAÑOS

MEDIDAS	UNIDADES	PRECIO	UNIDADES	PRECIO
10 x 10	10	10,23 €	50	9,71 €
10 x 10	10	7,12 €	50	6,76 €

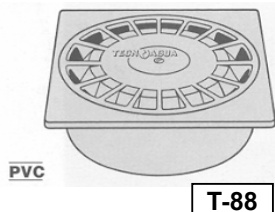
SUMIDERO SALIDA VERTICAL

PVC

T-88

CODIGO	MEDIDAS	UNIDADES	PRECIO	UNIDADES	PRECIO
50601	10 x 10	10	7,12 €	50	6,62 €
50636	15 x 15	10	7,33 €	45	6,82 €
50633	20 x 20	10	13,38 €	15	12,44 €
50632	25 x 25	6	14,75 €	13	13,72 €
750003150	30 x 30	5	27,14 €	11	25,24 €

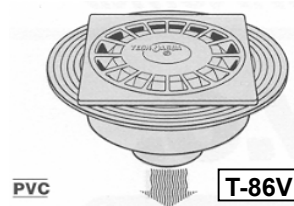
SUMIDERO CALDERETA SALIDA VERTICAL

PVC

T-86V

CODIGO	MEDIDAS	UNIDADES	PRECIO	UNIDADES	PRECIO
50630	20 x 20	10	20,12 €	15	18,71 €
50628	25 x 25	6	23,91 €	12	22,24 €
750014606	30 x 30	4	35,29 €		

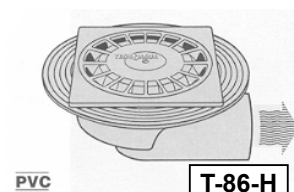
SUMIDERO CALDERETA SALIDA HORIZONTAL

PVC

T-86-H

CODIGO	MEDIDAS	UNIDADES	PRECIO
50644	20 x 20	6	22,81 €
50642	25 x 25	6	27,10 €
750022342	30 x 30	2	83,01 €

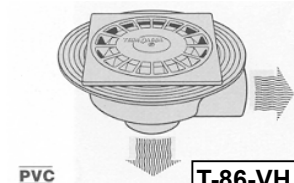
SUMIDERO CALDERETA SALIDA HORIZONTAL / VERTICAL

PVC

T-86-VH

CODIGO	MEDIDAS	UNIDADES	PRECIO
50640	15 x 15	10	14,41 €
50604	20 x 20	10	20,80 €

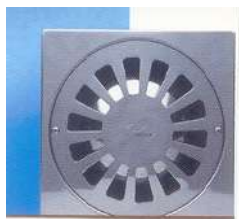
**SUMIDERO SALIDA VERTICAL****INOX**

CODIGO	MODELO	MEDIDA	CAJA	PRECIO / UD.
0439012736	C-201-M	20 x 20 Ø 75	3	159,30 €
0439011790	C-201-M	25 x 25 Ø 110	2	224,32 €

**SUMIDERO SALIDA HORIZONTAL****INOX**

CODIGO	MODELO	MEDIDA	CAJA	PRECIO / UD.
0439011691	C-203-M	15 x 15 Ø 75	4	107,20 €
0439011752	C-203-M	20 x 20 Ø 90	3	170,08 €
0439011783	C-203-M	25 x 25 Ø 110	2	241,49 €

INOX**SUMIDERO SALIDA VERTICAL****INOX**

CODIGO	MODELO	MEDIDA	CAJA	PRECIO / UD.
0439011684	C-202-M	15 x 15 Ø 75	4	107,18 €
0439011745	C-202-M	20 x 20 Ø 90	3	167,80 €
0439011806	C-202-M	25 x 25 Ø 110	2	237,40 €



Altura total de 7 cm., fabricado en ABS con rejilla inox AISI 304 BA. La estructura inferior con salida lateral de Ø 50 mm, que permite una rotación de 360°, ha sido especialmente estudiada para facilitar el posicionamiento del tubo de desagüe.

SUMIDEROS REBAJADOS EN ABS

CODIGO	MEDIDA	CAJA	PRECIO / UD.
TER02-1342I	15 X 15	6	17,77 €

13421

SUMIDEROS SIFONICOS

Fabricado en ABS, compuesto de rejilla y marco en acero inox AISI 304 BA. Producto ideal para soportar las agresiones químicas y atmosféricas. Altura estándar de 8 cm. La estructura de la base estándar está predispuesta para incrementar su altura con 2 posiciones de 0,80 cm cada una.



13401

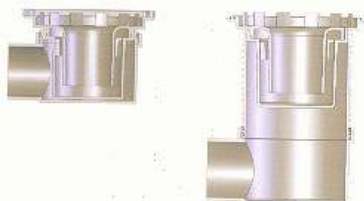

CODIGO	MEDIDA (mm)	CAJA	PRECIO / UD.
TER02-1340I	115 X 115	6	17,77 €

PROLONGACION TELESCOPICA

CODIGO	LONGITUD	CAJA	PRECIO / UD.
TER03-1343	Hasta 16 cm	6	1,63 €

1343



CANALETAS SUMIDERO CON REJILLA GARAGE

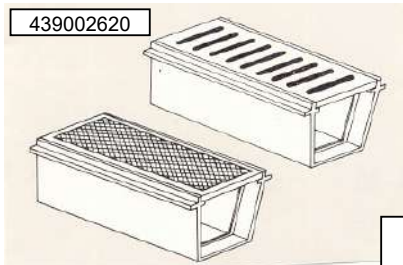

439002620

CODIGO	MEDIDAS	PRECIO	
		1 UNIDAD	2 CAJAS
439002620	C-208 52 x 17	32,39 €	29,75 €

Cada caja contiene:
9 canaletas = 4,5 Ml.

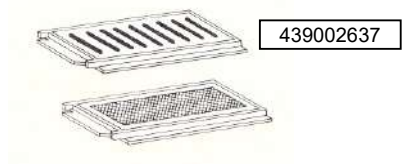

439002637

REJILLA	UNIDADES	PRECIO
C-207	1	41,60 €

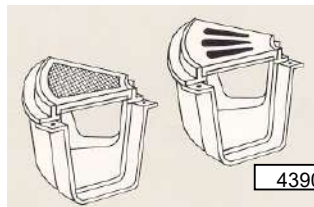

439002688

CODO CANALETA REJILLA C-212

UNIDADES	PRECIO
6	25,46 €

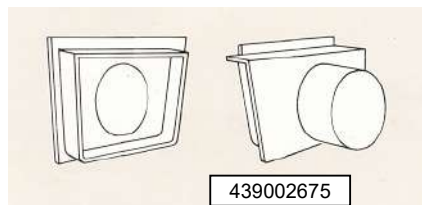

439002675

CONJUNTO TAPA Y SALIDA C-213

UNIDADES	PRECIO
3	16,15 €



439002651

SALIDA INTERMEDIA CANALETA C-211

UNIDADES	PRECIO
3	23,74 €

DAKOTA PROMOCIÓN CANALETA PEGASUS EN P.P.



La línea de "CANALETAS PEGASUS" está fabricada en polipropileno estabilizado. Las distintas medidas y accesorios completan con la línea "Taurus" la amplia gama de canaletas DAKOTA, con el fin de satisfacer las múltiples exigencias del mercado.

El modelo PEGASUS es un producto polivalente y económico. La canaleta puede ser colocada con rejilla de plástico, inoxidable y fundición hasta B-125

13 x H.7,5 x 100 cm

con rejilla galvanizada estampada

22,22 €/ud

con rejilla P.P.

22,22 €/ud

- 1) Pedido mínimo: 1 caja de 24 ud.
- 2) Producto fabricado conforme UNI EN 1443
- 3) IVA no incluido



POZ91-1350K

No 151

CANALETA POLIPROPILENO

DESCRIPCION	MEDIDAS (cm)	PRECIO/UD.
CANALETA P.P.	50 x 13 x 7,5	6,33 €
REJILLA P.P.	50 x 13	6,46 €
TAPON TERMINAL	13 x 7,5	3,61 €
BLOCK SYSTEM		3,63 €
REJILLA INOX	100 x 13	59,46 €

**OFERTA CAJA COMPLETA DE
24 TRAMOS**

**11,46 €
unidad**

KIT CANALETA PEGASUS REJILLA TECNOPOLIMERO



- Anti tacón 8 mm
- Anti oxidante
- Anti robo
- Anti ruido
- Anti estático
- Fácil de transportar
- Fácil de colocar
- Mayor paso de agua por rejilla: 103,68 cm²
- Normativa EN1433
- CE marcado

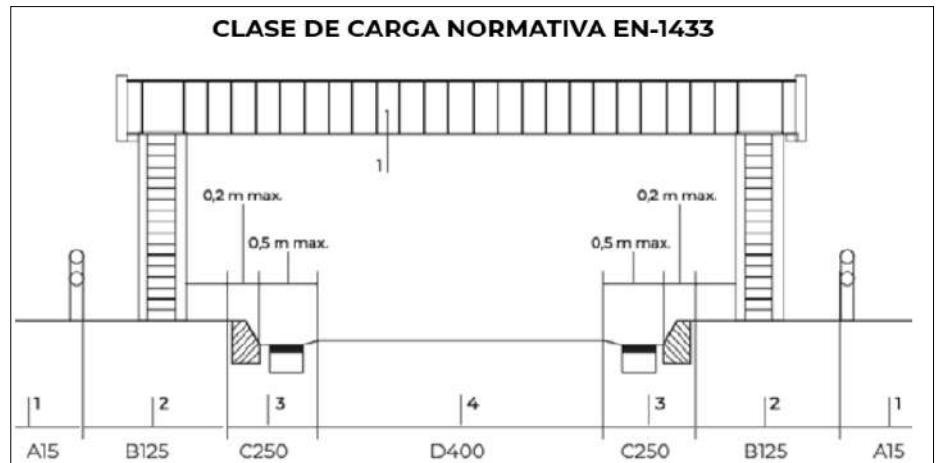

CODIGO	CLASE	MEDIDAS (mm)	PRECIO
			€
POZ90-1375TBB	B-125	130 x 75 x 1000	45,72 €



*Los 2 block sistem están incluidos en el precio de cada Kit.



Clase B125 = prueba de carga de 125 kN = 12,5 Tn
Grupo 2: Vías peatonales, aparcamientos o estacionamientos privados.

Manguitos Inodoro de Goma

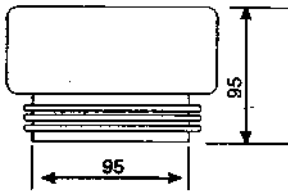

CONCENTRICO

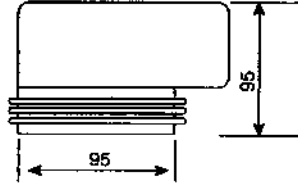

EXCENTRICO

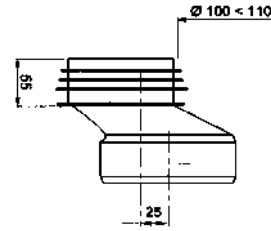

MAXI EXCENTRICO

CODIGO	UN.	PRECIO / Ud.
746002266	12	4,34 €

CODIGO	UN.	PRECIO / Ud.
746002285	12	4,34 €

CODIGO	UN.	PRECIO / Ud.
0746004074	12	4,81 €



CONCENTRICO

Manguitos Inodoro de PVC

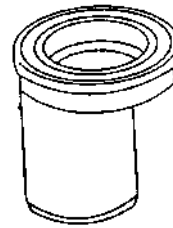

EXCENTRICO

CODIGO	MODELO	Ø	UN.	PRECIO / Ud.
MDI-01	C-144	90	12	3,75 €
MDI-02	C-144	110	12	4,08 €

CODIGO	MODELO	Ø	UN.	PRECIO / Ud.
MIE-10	C-145	90	12	3,75 €
MIE-20	C-148	110	12	4,08 €

Manguitos Inodoro de PVC con junta labiada



CONCENTRICO



EXCENTRICO



JUNTA LABIADA

CODIGO	UN.	PRECIO / Ud.
439008066	20	2,44 €

CODIGO	UN.	PRECIO / Ud.
MDL-30	12	5,18 €
	50	4,96 €

CODIGO	UN.	PRECIO / Ud.
MDL-40	12	5,18 €
	50	4,96 €



JUNTA MANGUITO INODORO

CODIGO	UN.	PRECIO / Ud.
439008059	20	2,44 €

Repuestos Botes Sifónicos y Valvulas Desagüe



C-142

Tapa expansión para bote sifónico Ø 110 con embellecedor inox 145 mm



C-143

Tapa expansión para bote sifónico Ø 110 con rejilla inox 145 mm

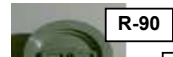

R-90

Tapa expansión para bote sifónico Ø 90 con embellecedor inox



S-190

Tapa cuadrada sumidero botes de Ø 100, valvula retención, embellecedor acero inox.



S-130 V

Medida a chorro Ref. 110x145 26060

Ur 10

n.º

PRECIO / Ud.

8,02 €

Válvula de aireación cerrada.



Válvula de aireación abierta.

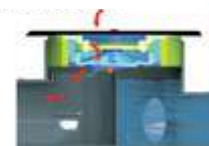

Compatible con botes sifónicos de salida saca (tipo S-153).

Con valvula de aireación integrada. Permite la entrada de aire para evitar el descebe del bote sifónico.

CODIGO	MODELO	UN.	PRECIO / Ud.
439001548	C-142	12	5,61 €
439001555	C-143	12	5,61 €
0750001262	S-190	6	13,46 €
39440490/1	R-90	6	4,53 €

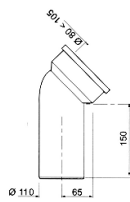

Manguito 22° para salida horizontal
Salida diámetro 110mm
Longitud 150mm

PRECIO
8,35 €

RWC 752001

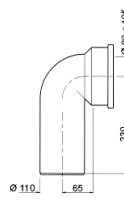

Manguito 90°
Salida diámetro 90mm
c/junta labiada d. 110 mm

PRECIO
11,44 €

71240001



REF.	SALIDA	CÓDIGO	APLICACIÓN	ALTURA	ENTRADA	U/C
T-117	Ø110	50674		DISTANCIA A PARED DISTANCE TO THE WALL 150	Ø90	30

PRECIO
12,10 €

MANGUITO INODORO SENSO



REF.	SALIDA	CÓDIGO	APLICACIÓN	ALTURA	ENTRADA	U/C
T-122	Ø110	50704		DISTANCIA A PARED DISTANCE TO THE WALL 210	Ø90	30

PRECIO
12,10 €

MANGUITO INODORO SENSO



REF.	SALIDA	CÓDIGO	APLICACIÓN	ALTURA	ENTRADA	U/C
T-119	Ø110	50703		—	Ø90	20

PRECIO
6,74 €

MANGUITO INODORO MÁXIMO DESPLAZAMIENTO



T-125	270 mm	50725		PARA MANGUITO T-122 y T-117	15
-------	--------	-------	--	--------------------------------	----

PRECIO
3,14 €

SISTEMA FIJACIÓN MANGUITO INODORO 270 mm

PAN CONNECTOR SCREW FIXING

ARQUETA BAJADA DE AGUAS

Arqueta universal para bajada de aguas



TER06-1386

UN PRECIO
6 **13,92 €**

No153

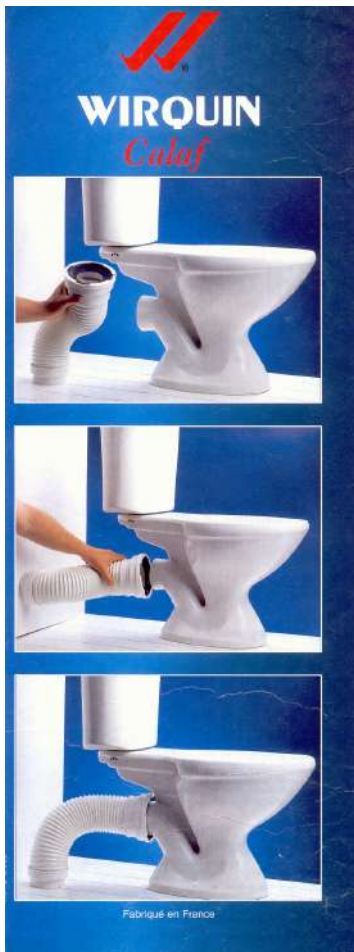

RWCE 1099

MANGUITO FLEXIBLE

LA RESPUESTA A TODOS LOS PROBLEMAS DE UNION !

Adaptable a todas las variables de salidas de cubetas.

Resistente a todo tipo de productos de mantenimiento y desatascadores.

Evacuación óptima, garantizada en cualquier posición.

Montaje simple y rápido

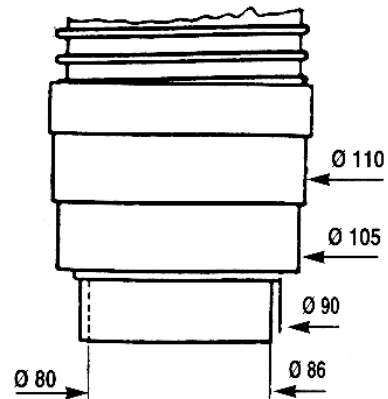

MEDIDA	PRECIO
290 - 400	27,04 €
360 - 580	38,49 €

MANGUITO INODORO EXTENSIBLE

T-118M

MEDIDA	PRECIO
180 - 350	15,75 €



Antisifónicos



Antisifónico para instalaciones en serie.

Antivaciado para evitar ruido, olores y el vaciado de los sifónicos. Instalaciones en serie.

REF.	ESPECIF.	CANT.	PRECIO
VP17	Ø 40 mm	10	8,79 €

Antisifónicos para instalaciones derivadas.

Antivaciado para evitar ruido, olores y el vaciado de los sifónicos. Instalaciones en derivación.



REF.	ESPECIF.	CANT.	PRECIO
VP35	Ø 40 y 50 mm	5	17,59 €
VP100	Ø 85 y 110 mm	2	59,41 €

NANO 6.7

UN CONCENTRADO DE TECNOLOGÍA

NANO 6.7 CON REBOSADERO NANO 6.7 QUICK-CLAC NANO 6.7 SALIDA LIBRE

PRECIO

40,31 €

PRECIO

34,82 €

PRECIO

36,23 €

AHORRO DE TIEMPO: un montaje rápido y sin herramientas



FUNCIÓN "QUICK SAFE":

- Tuerca unida al sifón para una conexión ¼ de vuelta
- Junta moldeada al sifón para una fiabilidad máxima



CONCEPTO ÚNICO DE CONEXIÓN DEL SIFÓN:

- práctica instalación con una sola mano



ORIENTACIÓN A 360° E INCLINACIÓN DE ± 4°:

- Compensa los defectos de alineación con el tubo
- Suprime la presión sobre el tubo de evacuación

Etapas de montaje



AHORRO DE ESPACIO: 3 veces menos voluminoso que un desagüe clásico



ULTRACOMPACTO: sólo 6.7 cm :

- El sifón desaparece totalmente
- Y libera espacio por debajo del lavabo.



neo AIR Y WIRQUIN NEO AIR

los sifones GARANTIZADOS SIN FUGAS



JUNTAS MOLDEADAS



JUNTAS MOLDEADAS
Gracias a la tecnología de la inyección, la estanqueidad es total, no hay pérdida de juntas y estas siempre están bien colocadas.

QUICK SAFE FUNCIÓN



FÁCIL MANTENIMIENTO
El vaso del sifón es fácil de desmontar (apertura 1/3 de vuelta).

QUICK SAFE FUNCIÓN
Garantía de una instalación rápida y fiable mediante tuerca 1/3 de vuelta unida al sifón y con junta moldeada.

WIRQUIN NEO AIR 1"¼ - 1"½ - Ø40

30722164
3375537220878
Sleeve-plástico retractado
55
1"¼ - 1"½
Ø40 mm
No
145<205 mm

PRECIO

6,94 €

WIRQUIN NEO AIR 1"¼ - 1"½ - Ø40 CON TOMA

30722163
3375537220861
Bolsa retractado
50
1"¼ - 1"½
Ø40 mm
Si
181<229 mm

PRECIO

13,26 €

neo AIR



AIR

FUNCION AIR SYSTEM

PRODUCTO 2 EN 1

Esta opción innovadora sustituye al antivaivado tradicional y permite evitar ruidos y malos olores.



SIN AIR SYSTEM

MALOS OLORES

aspiración del agua del sifón

RUIDO

CON AIR SYSTEM

NO ENTRAN MALOS OLORES

SIN RUIDO

aire natural

FUNCIONAMIENTO :
Cuando se crea una presión negativa en la tubería, todo el aire de la tubería será aspirado y luego todo el agua del sifón se verá aspirada a su vez (vaso).
WIRQUIN NEO AIR, permite una ventilación constante del sifón y que la tubería sea naturalmente ventilada.
Cuando se crea una presión negativa en la tubería la membrana del sifón **WIRQUIN NEO AIR** se levanta, lo que permite la ventilación constante para prevenir la aspiración del agua del sifón.

Click Clac



Válvula click-clack latón
Acabado NIQUEL INOX
Tapón exterior grande Ø63

Válvula click-clack latón
Acabado BLANCO
Tapón exterior grande Ø63

Válvula click-clack latón
Acabado NEGRO
Tapón exterior grande Ø63

Válvula click-clack latón
Acabado COBRE
Tapón exterior grande Ø63

Cod. 30611.NI

Cod. 30611.BL

Cod. 30611.NE

Cod. 30611.CO

PRECIO

21,94 €

PRECIO

23,30 €

PRECIO

12,95 €

PRECIO

21,94 €



Sifón botella latón
Acabado NIQUEL INOX
Diseño minimalista
cilíndrico

Sifón botella latón
Acabado BLANCO
Diseño minimalista
cilíndrico

Sifón botella latón
Acabado NEGRO
Diseño minimalista
cilíndrico

Sifón botella latón
Acabado COBRE
Diseño minimalista
cilíndrico

Cod. 30600.NI

Cod. 30600.BL

Cod. 30600.NE

Cod. 30600.CO

PRECIO

54,11 €

PRECIO

62,30 €

PRECIO

62,30 €

PRECIO

54,11 €

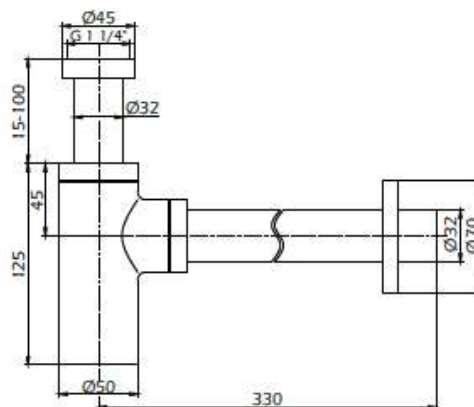

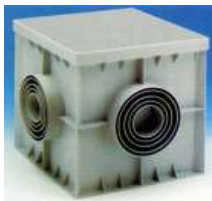

ARQUETA CON TAPA CIEGA O REJILLA

POZ01-1348K	20 x 20	15,85 €
POZ01-1358K	30 x 30	28,92 €
POZ01-1368K	40 x 40	57,35 €
POZ01-1378AK	55 x 55	105,62 €



PROLONGACION de 10 cm.

POZ05-1376	30 x 30	10,65 €
POZ05-1377	40 x 40	22,77 €



SIFON

POZ07-6821	30 x 30	10,54 €
POZ07-6822	40 x 40	19,44 €



TAPA CIEGA

POZ02-1348	20 x 20	5,63 €
POZ02-1358	30 x 30	12,20 €
POZ02-1368	40 x 40	24,97 €
POZ02-1378A	55 x 55	49,79 €



TAPA REJILLA

POZ03-1347	20 x 20	5,63 €
POZ03-1357	30 x 30	12,20 €
POZ03-1367	40 x 40	24,97 €
POZ03-1377A	55 x 55	49,79 €



MARCO REFORZADO

POZ04-1395	20 x 20	3,65 €
POZ04-1396	30 x 30	5,11 €
POZ04-1397	40 x 40	8,49 €
POZ04-1398	55 x 55	12,78 €



TAPADERA RELLENABLE

POZ08-6857S	30 x 30	11,19 €
POZ08-6858S	40 x 40	19,09 €



PLACA SIFONICA

POZ06-1378	20 x 20	2,89 €
POZ06-1379	30 x 30	3,58 €
POZ06-1380	40 x 40	5,51 €
POZ06-1389	55 x 55	15,17 €



TAPADERA SIFONADA

POZ09-1361S	30 x 30	28,93 €
POZ09-1371S	40 x 40	42,64 €
POZ09-1381S	55 x 55	80,26 €

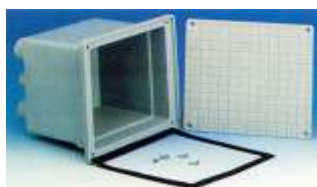

ARQUETA CABLES ELECTRICOS

POZ10-1347E	30 x 30	29,45 €
-------------	---------	----------------

LINEAL FLAT-DRY50**Descripción**

Canaleta sifónica con rejilla lineal y lámina impermeabilizante termosellada al sumidero FLAT de perfil bajo.

Lineal Flat DRY50

Referencia	Presentación (Lámina)	
DRY50 Lineal Flat 60	Caja 1 ud. (1,2x2m)	233,33 €
DRY50 Lineal Flat 70	Caja 1 ud. (1,5x2m)	260,42 €
DRY50 Lineal Flat 80	Caja 1 ud. (1,5x2m)	291,28 €
DRY50 Lineal Flat 90	Caja 1 ud. (1,5x2m)	318,33 €
DRY50 Lineal Flat 100	Caja 1 ud. (1,5x2m)	344,92 €
DRY50 Lineal Flat 120	Caja 1 ud. (1,5x2m)	388,00 €

Altura

62/42mm.

SalidasHorizontal
Ø 40/50 H.

Válvulas plato ducha Shower base valves

FIGURA FIG.	REF. PART	CÓDIGO CODE	APLICACIÓN APP.	CARACTERÍSTICAS DESCRIPTION	U/C U/C	MED. SIZE	EUROS EUROS
	T-79 C	50542		DESAGÜE URINARIO ACODADO CON PLAFON	s/p	1½	16,50
				Válvulas Plato ducha obra Standard.			
	T-71	50536		VÁLVULA PLATO DUCHA OBRA MASONRY SHOWER BASE VALVE 130 x 180	1	40-50	71,03
	T-71	50537		180x200	1	40-50	83,34
	T-71 L	50543		VÁLVULA PLATO DUCHA OBRA MASONRY SHOWER BASE VALVE 130 x 180	1	40-50	79,43
	T-71 L	50544		180x200	1	40-50	87,23

HIDROTUBO



DIAMETRO	Rollo	€/metro
Ø 20	50	2,48 €
Ø 25	50	2,53 €
Ø 32	50	2,64 €
Ø 40	50	3,11 €
Ø 50	50	4,82 €
Ø 63	50	9,27 €



HIDROTUBO® SÓLO HAY UNO

Creado y desarrollado por Espiropflex, S.A., **HIDROTUBO®** se diferencia de sus imitadores por su garantía de calidad en materiales y procesos de fabricación basados en la tecnología más avanzada del sector.

CALIDAD, PRESTIGIO Y GARANTÍA ESPIROFLEX

HIDROTUBO®, número uno en ventas, con exportación a más de 30 países, esta avalado por su larga trayectoria, calidad y experiencia en el mercado nacional e internacional.

Fórmula propia de materias primas, fabricado con los materiales elaborados en nuestra propia planta de producción, única en Europa.

OTROS PVC'S

- Reducción de la pared del tubo.
- No recubrimiento interior del pvc flexible.
- Reducción de la espiral rígida en un 30%.
- Materias primas de segunda calidad.
- Altos % de cracking (rotura del tubo por envejecimiento).
- Riesgo elevado de rotura por presión y aplastamiento.
- Desprotección ante posible siniestro. Ausencia de seguro.



El coste medio de reparación de una piscina por siniestro debido a la calidad de un tubo se cifra entorno a los 8.000 €.



RESISTENCIA TOTAL A LA ROTURA POR PRESIÓN.

100% DE GARANTÍA ANTI-CRACKING.
rotura por envejecimiento

MÁXIMA RESISTENCIA AL APLASTAMIENTO.

PRODUCTO TOTALMENTE ASEGURADO.
por compañía de seguros vinculada.

MATERIALES LIBRES DE COMPONENTES TÓXICOS:
plomo, catmio y amianto.

GARANTÍA ESPIROFLEX

100 % DE LAS PRODUCCIONES SOMETIDAS
A LOS MÁS ESTRICTOS CONTROLES DE CALIDAD

No 157



Promoción



Con refuerzo termoplástico helicoidal.
 Marcado en tramos de 1 metro para facilitar su medición y corte.

HIDROTUBO PVC
 Según Norma UNE EN ISO 3994:2001



	Ø	PRECIO metro
	32	2,47 €
	40	2,92 €
	50	4,64 €
	63	8,92 €
	Ø	PRECIO metro
	32	2,24 €
	40	2,65 €
	50	4,53 €
	63	8,70 €

BIG-BAGS

Fabricados en polipropileno, y dotados de 4 asas para facilitar su transporte.
Homologados para soportar hasta 1000 kg de peso.
Posibilidad de impresión.
Usos más habituales: transporte de tierra, arena, grava, escombros, almacenaje, etc.

CANTIDAD	PRECIO / UD.	
	HOMOLOGACION 1000 Kg. 90 x 90 x 90	HOMOLOGACION 500 Kg. 90 x 90 x 50
	50	5,61 €
500	CONSULTAR	CONSULTAR

CON VALVULA
PRECIO / UD.
HOMOLOGACION 1000 Kg. 90 x 90 x 100
6,80 €
CONSULTAR

MEDIDA (cm)
90 x 90 x 90
COLOR
Blanco



CONSULTAR PRECIO DE SACOS GRABADOS POR VARIACION DE PRECIOS DE LAS MATERIAS PRIMAS.

SACOS ARENA PARA 45 Kg
MEDIDAS: 50 x 80 cm

PRECIO / Ud.
0,47 €

FILM ESTIRABLE MANUAL

Film estirable para el enfardado de palets.
Protege la mercancía del polvo y agua, así como la fija al palet.
En formato de 125mm es ideal para hacer agrupaciones, perfiles, talleres, etc.
Disponible en espesor de 23 My.

MEDIDA (cm)	COLOR
500 mm	Transparente



CANTIDAD	PRECIO / UD.
1	7,26 €
15 Cajas	6,67 €

DISPENSADORES FILM ESTIRABLE

Siguiendo con nuestra línea de respeto al medio ambiente, el film sin mandril no utiliza el cartón interior, ni requiere ninguna gestión ni coste de reciclaje. Pague sólo por el film que utiliza y evite la picaresca del peso del cartón. Es una bobina más ligera y de menor volumen a igualdad del peso del film.



PRECIO / UD.
9,17 €

CINTA DE SENALIZACION

Ideal y económica para la delimitación de obras, zonas acotadas, eventos deportivos, etc...
De facil instalación y gran visibilidad.
Posibilidad de personalizar o imprimir.

MEDIDA	COLOR
7 cm x 200 M	Blanco / Rojo



CANTIDAD	PRECIO / UD.
20	4,38 €

MALLA DE SENALIZACION

Malla de plástico, de color naranja, ideal para delimitar zonas de obras, eventos deportivos, etc...
Alta visibilidad y tratada anti-UV, lo que le proporciona gran resistencia y durabilidad.

MEDIDA (M)	COLOR
1 x 50	Naranja

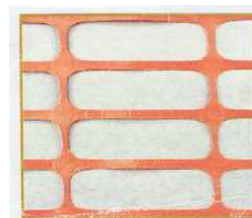

PRECIO
1,10 € M²

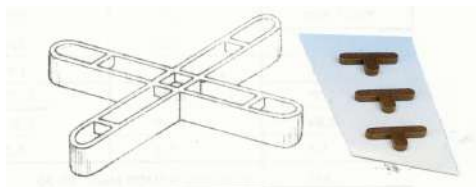
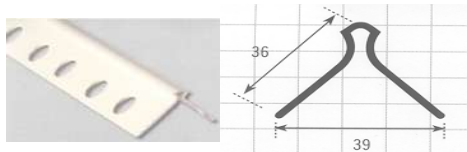
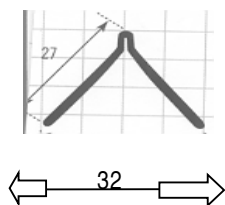
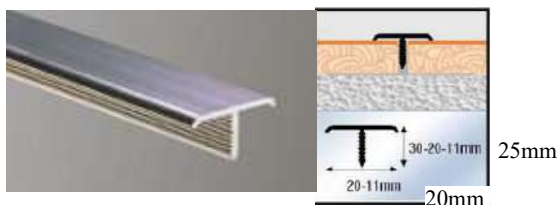

LISTELO ACERO INOX

Listelo decorativo para proteger esquinas con un acabado de líneas rectas en revestimientos y embellecer pavimentos cerámicos de cualquier estilo.

Material protegido con film.

Perfiles de 2,60 metros de longitud

Cajas de 20 unidades

MEDIDA	UN	PRECIO/UD
25 x 12	20	31,50 €

LISTELO ALUMINIO "T" Brillo 2,60 metros

ENVASE	PRECIO/UD
10	11,46 €

PERFIL ALUMINIO Plata 2,60 metros

ENVASE	PRECIO/UD
20	7,67 €
2 CAJAS	Dto. 5%

PERFIL ALTA CALIDAD 8.5

Colores: Blanco, Marfil, Gris Claro, Negro, Gris Oscuro

ENVASE	PRECIO/UD
1 CAJA	1,12 €
2 CAJAS	1,03 €

PERFIL ALTA CALIDAD 10.5

Colores: Blanco, Marfil, Gris Claro, Gris Oscuro

ENVASE	PRECIO/UD
100	1,25 €

PERFIL YESERO

ENVASE	PRECIO/UD
1 CAJA	1,04 €
2 CAJAS	0,94 €

PERFIL MONOCAPA 2,5 metros

ENVASE	PRECIO/UD
50	1,93 €

CRUCETAS Y TES SEPARADORAS

MEDIDA	ENVASE	PRECIO / BOLSA
3 mm	200	2,90 €
5 mm	200	2,90 €
7 mm	200	2,90 €
10 mm	200	4,08 €

CUÑA SEPARADORA AZULEJO

ENVASE	PRECIO / BOLSA
500	6,63 €

RED PARA ANDAMIO

Red protege andamios verde/blu

MEDIDAS	PRECIO M ²
3 x 16	1,02 €
3 x 25	1,02 €



Tapa + Marco T2060A / T2061N



Registro transit 600.
Marco Ø675 x 45mm, tapa Ø585mm, paso libre de Ø545mm.
Fundición dúctil, resistencia máxima aproximada de 15 tn.
Sin clase según EN-124.
Acabado en pintura asfáltica.

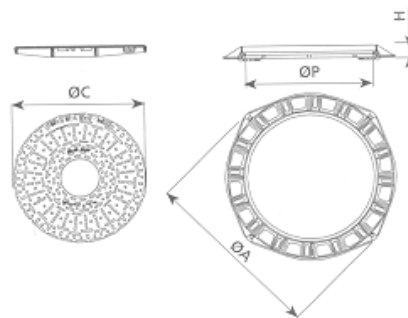

Referencia		Ø A	H	Ø C	Ø P	Un.	PRECIO
T-2060A	B-125	700	45	585	545	2	102,23 €
RG6FRC2	C-250	805	60	620	600	2	132,16 €



Reja + Marco imbornal R0954

Marco 570x370x35mm, reja de 535x335mm, articulada, superficie cóncava y antideslizante. Fundición dúctil. Acabado en pintura asfáltica.

Referencia	A x B	H	C x D	P x P1	Absorción	Un.	PRECIO
					dm²		
R0954	570x370	40	535x335	500x300	8	6	86,82 €

Tapa + Marco TH

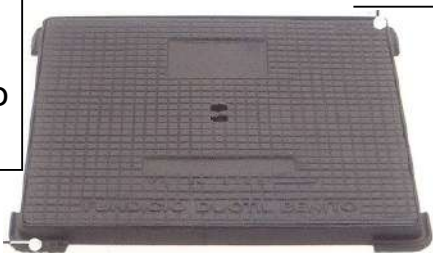

Identificación producto certificado

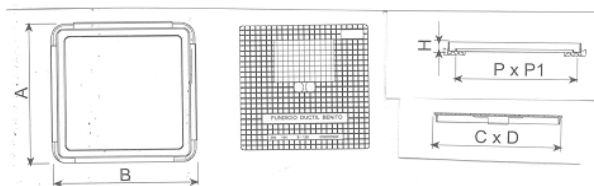

Registro modelo hidráulica, fundición dúctil. Cumple norma UNE EN-124, clase B-125. Acabado en pintura asfáltica.

Referencia	A x B	H	C x D	P x P1	Un.	PRECIO
TH25	275x275	35	230x230	195x195	6	19,50 €
TH30	325x325	35	285x285	245x245	6	20,58 €
TH40	425x425	35	390x390	345x345	6	35,74 €
TH50	520x520	35	480x480	435x435	2	60,00 €
TH60	625x625	40	580x580	535x535	2	83,12 €
TH70	750x750	45	680x680	610x610	2	138,78 €
TH80	850x850	45	780x780	710x710	2	179,99 €

Patas de AGARRE, para una mejor sujeción.

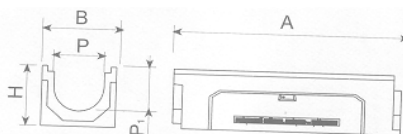

Conjunto canal + reja de fundición dúctil. Cumple norma EN-124, clase D-400. Acabado en pintura asfáltica.

Canal + Reja RC20

A x B	H	P x P1	Kg	PRECIO
750x225	160	165x120	2	97,87 €

Tapa + Marco T2063

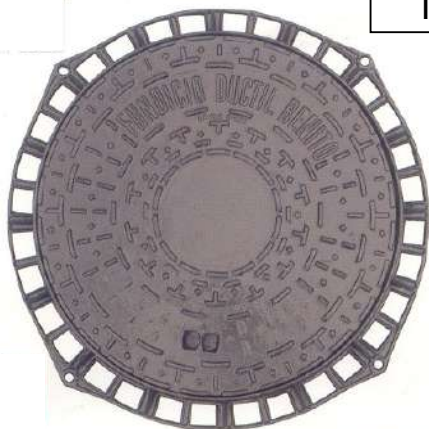

Registro RDA 100.
Marco Ø850 x 100mm, tapa Ø650mm,
paso libre de Ø600mm.
Junta de insonorización de poliuretano y
elemento de cierre.
Fundición dúctil, cumple norma UNE EN
214 Clase D-400
Acabado en pintura asfáltica.

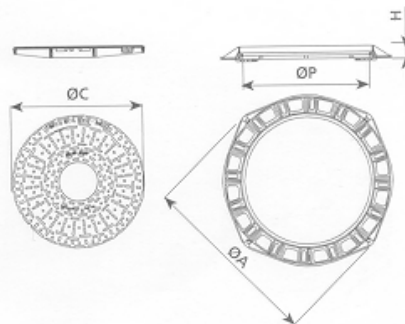

Referencia	Ø A	H	Ø C	Ø P	Un.	PRECIO
T-2063	825	103	625	600	2	148,41 €



C-250

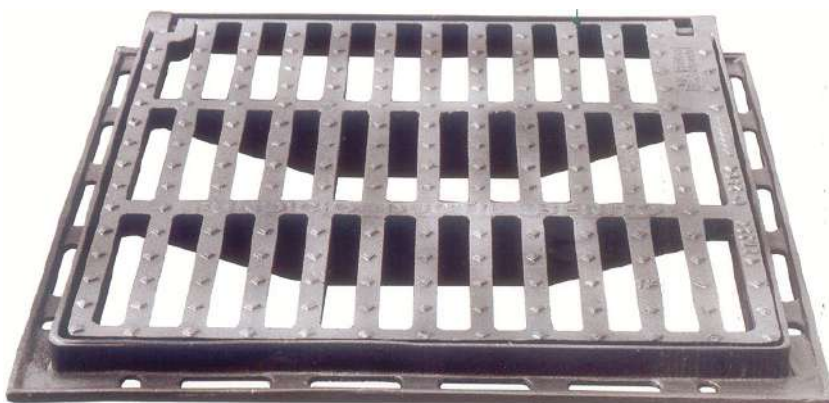

Reja PLANA

Perfil recto

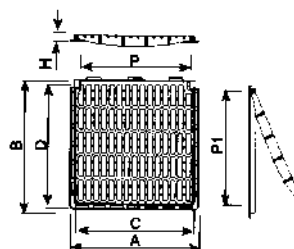

Referencia	A x B	H	C x D	P x P1	Sup. Absorción	Un.	PRECIO
RP30	360x360	35	300x300	260x260	4 dm ²	6	43,33 €
RP40	460x460	35	400x400	350x350	8 dm ²	6	58,33 €
RP50	560x560	35	500x500	440x440	12 dm ²	2	97,49 €
RP60	660x660	35	600x600	550x550	15 dm ²	2	146,24 €

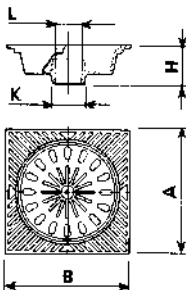
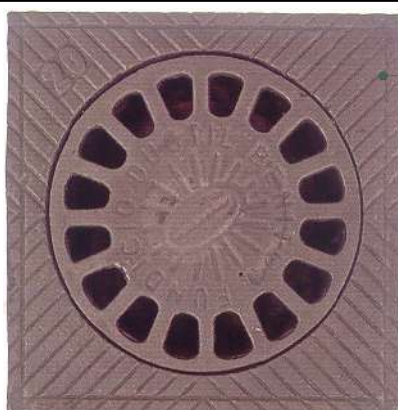

Sumideros FUNDICION

Referencia	A x B	H	K	L	Un.	PRECIO
SF20	200x200	60	50	40	6	12,52 €
SF25	250x250	75	80	70	6	20,85 €
SF30	300x300	75	100	90	2	28,60 €

Boca de Llave



Referencia	A x B	H	C x D	P x P1	Un.	PRECIO
BL12AG	120x120	28	100x80	100x85	6	9,10 €
BL24AG	245x170	30	220x150	195x130	6	18,20 €

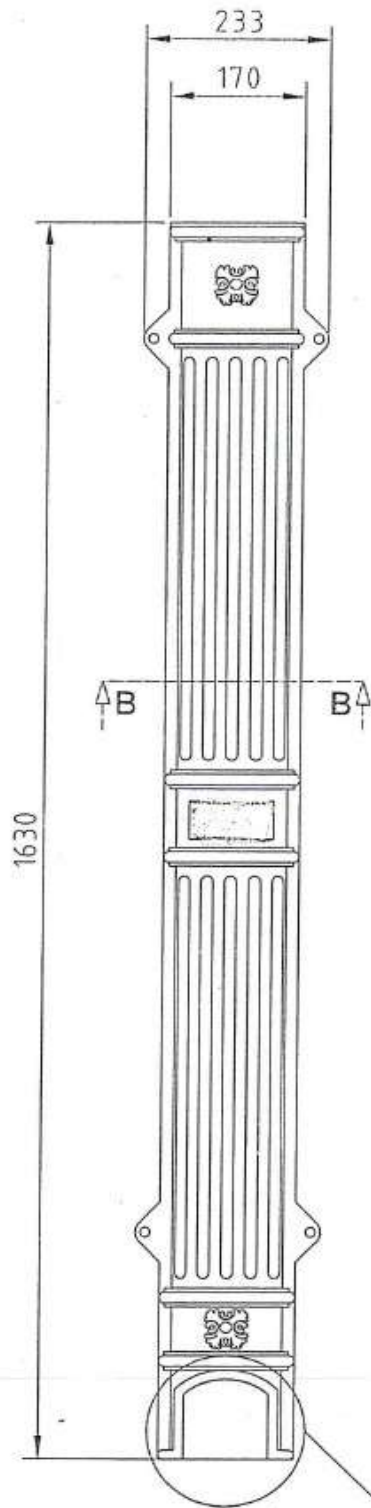

SECCIÓN B-B
ESCALA 1:5

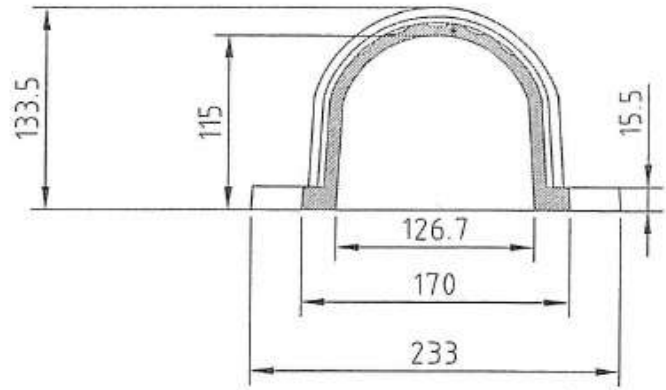

**CUBRE-BAJADA DE PLUVIALES
FUNDICION**

1630 x 120 x 105

MAXIMO TUBO Ø 100

DETALLE A
ESCALA 1:5

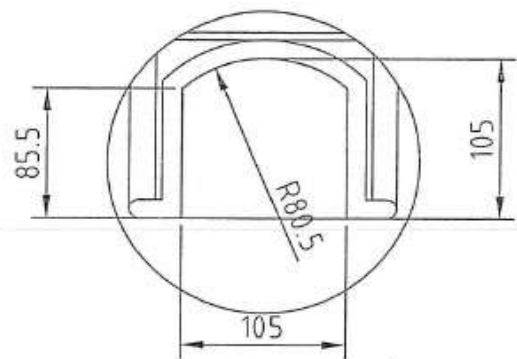

DETALLE A

PRECIO
225,00 €



PRECIO

222,75 €

Cenicero

- Cuerpo y cubeta interior en acero galvanizado.
- Parte superior apaga cigarrillos en acero inoxidable.
- Acabados: Pintado en color negro.
- Base de fijación mediante pernos de expansión.



PRECIO

105,75 €

Ref. VC1

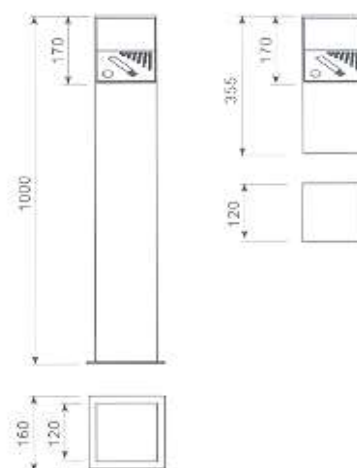
Ref. VC2
(para pared)

Diseño: Franc Dey, 2005 © Fundició Dúctil Benito

VACIADO DE COLILLAS

1.



2.



No 164

Depósitos de Agua



CONICO

300	Volumen	ø	h.	CÓDIGO	161,67 €
	300	90	120	TK-CNA003	

500	Volumen	ø	h.	CÓDIGO	211,67 €
	500	104	138	TK-CNA005	

1000	Volumen	ø	h.	CÓDIGO	308,33 €
	1000	120	150	TK-CNA010	

TINAJA



300	Volumen	ancho	h.	260,00 €
	294	80	85	

OR30P

TANKONE Utilización doméstica

Fosa filtro

Encuéntrala en abundancia
Tabla III

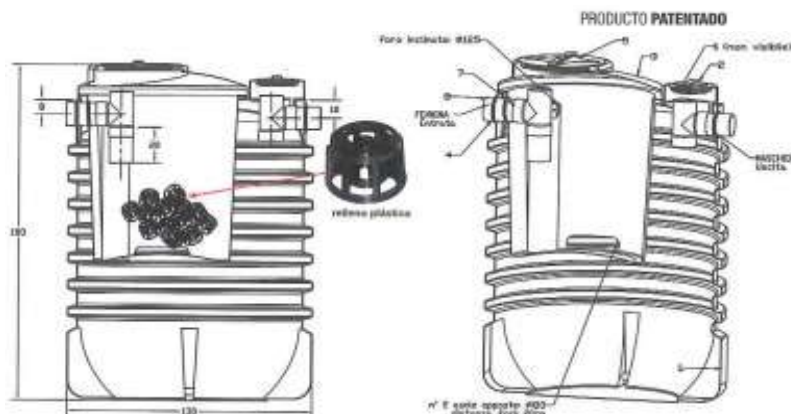

artículo	tipo	Volumen dig.	Volumen filtro	H.E. DBO 35%	H.E. DBO 87%	ø base cm	alt.	ø tubo	H en cm	H out cm	tapas
IFF12	2000	1400	600	12	7	130	180	125	160	155	25
P2525	Prolongación aplicable H 25										

PRECIO **1.760,00 €**

Codos Macho - Hembra 45°



Referencia	Medida Ø	Unidades Caja	PRECIO UD.
CMH-101A	32	300	0,58
CMH-104	40	255	0,50
CMH-107	50	100	0,94
CMH-110	75	85	1,67
CMH-113	90	60	2,00
CMH-116A	110	35	2,47
CMH-119	125	24	3,60
CMH-122	160	16	8,90
CMH-125	200	6	12,18
CMH-128	250	2	33,79
CMH-131	315	1	69,63
CMH-134	400	1	304,00

Codos Macho - Hembra 67° 30'



Referencia	Medida Ø	Unidades Caja	PRECIO UD.
CMH-102	32	265	0,68
CMH-105	40	140	0,88
CMH-108	50	120	0,97
CMH-111	75	85	1,54
CMH-114	90	55	2,20
CMH-117	110	30	2,57
CMH-120	125	25	3,59
CMH-123	160	12	8,49
CMH-126	200	6	22,65

Codos Macho - Hembra 87° 30'



Referencia	Medida Ø	Unidades Caja	PRECIO UD.
CMH-103	32	320	0,56
CMH-106	40	200	0,66
CMH-109	50	105	0,93
CMH-112	75	80	1,30
CMH-115	90	45	1,90
CMH-118	110	50	3,02
CMH-121	125	40	3,42
CMH-124	160	12	7,07
CMH-127	200	9	12,60
CMH-130	250	2	45,83
CMH-133	315	1	88,45
CMH-136	400	1	356,58

Codo PVC Blanco Ventilación camaras de aire



CODIGO	MEDIDA Ø	UNIDADES	PRECIO
220020	20	100	0,72 €
	20	400	0,68 €

Codos Hembra - Hembra 45°



Referencia	Medida Ø	Unidades Caja	PRECIO UD.
CHH-01	32	375	0,44
CHH-04A	40	240	0,66
CHH-07	50	130	0,87
CHH-10	75	75	3,45
CHH-13	90	45	3,81
CHH-16	110	30	2,75
CHH-19	125	20	8,15
CHH-22	160	10	17,46
CHH-25	200	6	18,46
CHH-28	250	1	104,13

Codos Hembra - Hembra 67° 30'



Referencia	Medida Ø	Unidades Caja	PRECIO UD.
CHH-02	32	350	0,68
CHH-05	40	210	0,94
CHH-08A	50	125	0,87
CHH-17	110	25	4,43

Codos
Hembra - Hembra 87° 30'

Referencia	Medida Ø	Unidades Caja	PRECIO UD.
CHH-03A	32	350	0,42
CHH-06A	40	190	0,67
CHH-09	50	105	0,86
CHH-12	75	50	3,59
CHH-15	90	45	2,89
CHH-18	110	25	4,22
CHH-21	125	22	4,27
CHH-24	160	10	14,53
CHH-27	200	5	27,98
CHH-30	250	1	128,38

Curva ALTO IMPACTO

Referencia	Medida Ø	Unidades Caja	PRECIO UD.
Curva ALTO IMPACTO H-H Reforzada			
CAI-18	110	4	8,10
Curva ALTO IMPACTO M-H Reforzada			
CAI-118	110	4	8,10

Derivación
Macho - Hembra 45°

Referencia	Medida Ø	Unidades Caja	PRECIO UD.
DSM-101	32	60	1,19
DSM-104	40	60	1,24
DSM-107	50	50	1,77
DSM-110	75	48	2,43
DSM-113	90	28	3,73
DSM-116	110	30	4,59
DSM-119	125	20	6,39
DSM-122	160	5	14,27
DSM-125	200	5	35,71
DSM-128	250	2	75,01
DSM-131	315	1	258,59
DSM-134	400	1	913,00

Derivación
Macho - Hembra 67° 30'

Referencia	Medida Ø	Unidades Caja	PRECIO UD.
DSM-111	75	48	2,66
DSM-114	90	28	3,83
DSM-117	110	30	4,80
DSM-120	125	20	7,21
DSM-123	160	5	22,70
DSM-126	200	5	108,50

Derivación
Macho - Hembra 87° 30'

Referencia	Medida Ø	Unidades Caja	PRECIO UD.
DSM-103	32	200	0,64
DSM-106	40	110	1,10
DSM-109	50	60	1,61
DSM-112	75	60	2,15
DSM-115	90	40	2,89
DSM-118	110	42	4,55
DSM-121	125	18	5,22
DSM-124	160	8	13,65
DSM-127	200	4	35,94
DSM-130	250	1	60,47
DSM-133	315	1	112,16

**Derivación
Hembra - Hembra 45°**

Referencia	Medida Ø	Unidades Caja	PRECIO UD.
DS-01	32	100	0,72
DS-04	40	105	1,05
DS-07	50	50	1,24
DS-10	75	40	6,88
DS-13	90	28	10,08
DS-16	110	14	11,63
DS-19	125	12	7,83
DS-22	160	5	19,60
DS-25	200	3	45,15

**Derivación
Hembra - Hembra 67° 30'**

Referencia	Medida Ø	Unidades Caja	PRECIO UD.
DS-02	32	125	0,97
DS-05	40	90	0,93
DS-08	50	60	1,24

**Derivación
Hembra - Hembra 87° 30'**

Referencia	Medida Ø	Unidades Caja	PRECIO UD.
DS-03	32	185	0,62
DS-06	40	100	1,05
DS-09	50	55	1,19
DS-12	75	30	6,12
DS-15	90	20	8,59
DS-18	110	17	4,94
DS-21	125	14	12,96
DS-24	160	6	49,99
DS-27	200	2	68,05

**Derivación doble plana
Hembra - Hembra 45°**

Referencia	Medida Ø	Unidades Caja	PRECIO UD.
DMH-104	40 (40-40-40)	60	3,06
DMH-107	50 (40-40-40)	55	3,06

**Derivación doble plana
Macho - Hembra 45°**

Referencia	Medida Ø	Unidades Caja	PRECIO UD.
DMH-210	75	13	6,12
DMH-213	90	20	7,22
DMH-216	110	10	9,74
DMH-219	125	7	13,09
DMH-222	160	4	46,68
DMH-225	200	2	131,77
DMH-228	250	1	611,61
DMH-231	315	1	832,45

**Derivación doble plana
Macho - Hembra 67° 30'**

Referencia	Medida Ø	Unidades Caja	PRECIO UD.
DMH-223	160	4	113,77
DMH-226	200	2	210,92
DMH-229	250	1	502,62
DMH-232	315	1	835,35

**Derivación doble plana
Macho - Hembra 87° 30'**

Referencia	Medida Ø	Unidades Caja	PRECIO UD.
DMH-212	75	16	5,41
DMH-215	90	12	6,42
DMH-218	110	12	6,63
DMH-211	125	12	11,74
DMH-224	160	10	43,51
DMH-227	200	2	210,05
DMH-230	250	1	475,58
DMH-233	315	1	788,80



**Derivación Doble escuadra
Macho - Hembra 45°**

Referencia	Medida Ø	Unidades Caja	PRECIO UD.
DDE-113	90	5	56,89
DDE-116	110	9	43,89
DDE-119	125	8	50,16
DDE-122	160	2	127,09
DDE-125	200	2	240,92

**Derivación Doble escuadra
Macho - Hembra 67° 30'**

Referencia	Medida Ø	Unidades Caja	PRECIO UD.
DDE-114	90	5	47,50
DDE-117	110	4	63,51
DDE-120	125	8	69,04
DDE-123	160	4	122,82
DDE-126	200	2	255,08

**Derivación Doble escuadra
Macho - Hembra 87° 30'**

Referencia	Medida Ø	Unidades Caja	PRECIO UD.
DDE-115	90	5	47,50
DDE-118	110	6	39,83
DDE-121	125	6	68,98
DDE-124	160	4	122,82
DDE-127	200	2	240,92

**Injertos
clip**

Referencia	Medida Ø	Corona Ø	Unidades Caja	PRECIO UD.
INJ-04	75-32	48	150	1,58
INJ-05	75-40	48	150	1,60
INJ-06	75-50	57	150	1,60
INJ-07	90-32	48	150	1,61
INJ-08	90-40	48	150	1,61
INJ-09	90-50	57	150	1,61
INJ-10	110,32	48	150	1,61
INJ-11	110-40	48	150	1,61
INJ-12	110-50	57	150	1,61
INJ-13	125-32	48	150	1,61
INJ-14	125-40	48	150	1,61
INJ-15	125-50	57	150	1,61
INJ-16	160-32	48	150	1,74
INJ-17	160-40	48	150	1,74
INJ-18	160-50	57	150	1,74
INJ-19	125-110	102	45	6,49

**Injertos clip
67° 30'**

Referencia	Medida Ø	Corona Ø	Unidades Caja	PRECIO UD.
INJ-22	110-32	48	150	1,77
INJ-23	110-40	48	150	1,84
INJ-24	110-50	57	150	1,77

**Injerto a tubo
reforzado**

Referencia	Medida Ø	Corona Ø	Unidades Caja	PRECIO UD.
INJ-20	160-110	102	40	6,49
INJ-21	160-125	102	40	6,49

**Injertos
abrazadera**

Referencia	Medida Ø	Corona Ø	Unidades Caja	PRECIO UD.
INA-01	110-125/40	48	125	1,43
INA-02	110-125/50	48	105	1,43
INA-11	90/40	48	150	1,38
INA-22	90/50	48	150	1,38



EVACUACIÓN
Injertos abrazadera seguridad

Referencia	Medida Ø	Corona Ø	Unidades Caja	PRECIO UD.
INS-01	110-125/40	48	60	1,80
INS-02	110-125/50	48	60	1,80

Injertos seguridad colocación externa

Referencia	Medida Ø	Corona Ø	Unidades Caja	PRECIO UD.
IRS-32	110-125/40	70	100	2,56
IRS-33	110-125/50	70	110	2,56

Injertos a tubo 45° con junta goma

Referencia	Medida Ø	Unidades Caja	PRECIO UD.
IT-01	200-110	16	19,58
IT-02	200-125	14	22,85

Injertos a tubo 90°

Referencia	Medida Ø	Unidades Caja	PRECIO UD.
IT-14	110-90	12	22,26

Injertos a tubo 90°

Referencia	Medida Ø	Unidades Caja	PRECIO UD.
IT-13	90-75	8	19,31
IT-15	125-110	6	28,31
IT-19	160-110	8	49,94
IT-20	160-125	8	53,84
IT-03	200-90	4	47,15
IT-04	200-110	4	51,49
IT-05	200-125	4	55,15
IT-06	200-160	4	59,03
IT-07	250-160	3	112,74
IT-08	250-200	3	187,13

Injertos a tubo 45°

Referencia	Medida Ø	Unidades Caja	PRECIO UD.
IT-16	90-75	8	19,31
IT-17	110-90	7	22,26
IT-18	125-110	6	28,31
IT-22	160-110	6	49,94
IT-21	160-125	6	53,84
IT-09	200-90	4	47,15
IT-10	200-160	4	59,03
IT-11	250-160	3	112,74
IT-12	250-200	3	187,13

Injerto Abrazadera con cierre cremallera.

Referencia	Medida Ø	Unidades Caja	PRECIO UD.
IAC-10	110-40	80	1,68
IAC-20	110-50	75	1,68

Ventajas: Rapidez en el montaje.

No necesita elementos auxiliares, tales como alambres u otros para sujetarlo.

No tiene que esperar al secado del adhesivo.

Gracias al cierre de arpón con cremallera el injerto queda totalmente sujeto y adherido.



**Sector codo 15°
Macho - Hembra**

Referencia	Medida Ø	Unidades Caja	PRECIO UD.
SC-16	110	30	2,69
SC-19	125	46	3,85
SC-22	160	32	5,94

**Sector codo 22°
Macho - Hembra**

Referencia	Medida Ø	Unidades Caja	PRECIO UD.
SC-17	110	30	4,58
SC-20	125	20	5,05

**Sector codo 30°
Macho - Hembra**

Referencia	Medida Ø	Unidades Caja	PRECIO UD.
SC-18	110	25	2,93
SC-21	125	40	4,12
SC-24	160	20	6,55

**Sifón con registro
Gris RAL 7037**

Referencia	Medida Ø	Unidades Caja	PRECIO UD.
SG-110	110	4	31,68
SG-125	125	3	32,08
SG-160	160	2	73,69
SG-200	200	1	131,33

**Enlace mixto PVC con tubos
roscados no encolables.
(Tuerca loca). Con junta plana
adaptado para válvulas click-clack.**

Referencia	Medida Ø	Unidades Caja	PRECIO UD.
ETP-01	40 - 1 ¼"	55	1,08
ETP-02	40 - 1 ½"	40	1,08

**Enlace mixto PVC con tubos
roscados, no encolables.
(Tuerca loca)**

Referencia	Medida Ø	Unidades Caja	PRECIO UD.
ETL-01	40 - 1 ¼"	55	1,08
ETL-02	40 - 1 ½"	45	1,08

**Racor conexión desagüe
caldera M-H rosca Hembra**

Referencia	Medida Ø	Unidades Caja	PRECIO UD.
	M-H x H		
RDH-02	40-32 x ½"	100	1,34
RDH-03	40 32 x ¾"	100	3,39

**Racor conexión desagüe
caldera M-H rosca Macho**

Referencia	Medida Ø	Unidades Caja	PRECIO UD.
	M-H x M		
RDM-01	40-32 x ½"	100	1,34
RDM-04	40 32 x ¾"	100	3,62

**Codo 45°
doble toma**

Referencia	Medida Ø	Unidades Caja	PRECIO UD.
CCT-116	110/50-50	12	6,59
CCT-119	125/50-50	8	12,25

**Codo 67° 30'
doble toma**

Referencia	Medida Ø	Unidades Caja	PRECIO UD.
CCT-117	110/50-50	10	11,50

**Codo 87° 30'
doble toma**

Referencia	Medida Ø	Unidades Caja	PRECIO UD.
CCT-115	90/50-50	15	6,45
CCT-118	110/50-50	20	6,34
CCT-121	125/50-50	16	9,99



Codo 87° 30'
una toma

Referencia	Medida Ø	Unidades Caja	PRECIO UD.
CD-115	90 / 50	17	10,45
CD-118	110 / 50	12	8,13

Tapón reducido simple
Macho

Referencia	Medida Ø	Unidades Caja	PRECIO UD.
TRS-01	75-32	160	1,20
TRS-02	75-40	160	1,18
TRS-03	75-50	160	1,18
TRS-80	80-40	128	1,70
TRS-81	80-50	128	1,70
TRS-04	90-32	110	1,67
TRS-05	90-40	110	1,54
TRS-06	90-50	110	1,54
TRS-07	110-32	90	1,95
TRS-08	110-40	90	1,81
TRS-09	110-50	90	1,82
TRS-10	125-32	65	1,90
TRS-11	125-40	65	2,36
TRS-12	125-50	65	2,36

Tapón reductor
Macho

Referencia	Medida Ø	Unidades Caja	PRECIO UD.
TRS-25	90-75	60	1,81
TRS-13	110-75	54	2,78
TRS-14	110-90	54	3,05
TRS-26	125-75	20	2,92
TRS-15	125-90	40	3,29
TRS-16	125-110	40	3,45
TRS-17	160-125	24	6,58
TRS-18	160-110	24	6,34
TRS-27	200-110	16	12,98
TRS-19	200-160	16	12,46
TRS-20	200-125	16	12,35
TRS-21	250-200	6	28,16
TRS-22	250-160	6	27,88
TRS-23	315-200	7	48,34
TRS-24	315-250	7	48,34

Tapón reducido
Macho Doble

Referencia	Medida Ø	Unidades Caja	PRECIO UD.
TRD-01	90-40-32	110	1,50
TRD-02	90-40-40	10	1,54
TRD-03	90-32-32	110	1,47
TRD-04	110-50-40	90	1,79
TRD-05	110-50-32	90	1,90
TRD-06	110-40-40	90	1,86
TRD-07	110-40-32	90	1,86
TRD-08	110-32-32	90	1,86
TRD-09	125-40-32	65	2,48
TRD-10	125-50-32	65	2,48
TRD-11	125-50-50	65	2,59
TRD-12	125-50-40	65	2,59
TRD-13	125-40-40	65	2,36

Tapón reducido
Macho - Triple

Referencia	Medida Ø	Unidades Caja	PRECIO UD.
TRT-01	110-40-40-40	90	1,79
TRT-02	110-50-40-40	90	1,76
TRT-03	125-50-40-40	65	2,85
TRT-04	125-50-40-32	65	2,85
TRT-05	125-40-40-40	65	2,85

Tapón reducido Macho
Doble - Tapado

Referencia	Medida Ø	Unidades Caja	PRECIO UD.
TDT-15	110-40-40	90	1,59
TDT-161	110-50-40	90	1,59



Tapón reducido Macho Triple - Tapado

Referencia	Medida Ø	Unidades Caja	PRECIO UD.
TTT-31	110-40-40-40	90	1,77
TTT-32	110-50-40-40	90	1,76
TTT-33	125-50-40-40	65	2,97
TTT-34	125-50-40-32	65	2,97
TTT-35	125-40-40-40	65	2,97



Tapones ciegos Macho



Referencia	Medida Ø	Unidades Caja	PRECIO UD.
TC-01	32	225	0,45
TC-02	40	170	0,48
TC-03	50	75	0,66
TC-04	75	160	0,90
TC-05	90	110	1,19
TC-06	110	90	1,47
TC-07	125	65	1,89
TC-08	160	24	5,46
TC-09	200	12	8,24
TC-10	250	6	16,28
TC-11	315	7	29,04
TC-12	400	1	165,83

Tapones ciegos Hembra



Referencia	Medida Ø	Unidades Caja	PRECIO UD.
TEL-01	40	150	0,27
TCH-06	110	90	1,93

Tapones de registro Macho con junta goma tórica



Referencia	Medida Ø	Unidades Caja	PRECIO UD.
TRG-01	32	200	0,83
TRG-02	40	300	1,03
TRG-03	50	250	1,24
TRG-04	75	84	1,68
TRG-05	90	64	2,44
TRG-06	110	48	3,33
TRG-07	125	36	3,86
TRG-08	160	12	11,44
TRG-09	200	8	28,24
TRG-10	250	5	47,07
TRG-11	315	2	174,37

Tapón rosca largo para pruebas con junta tórica

Referencia	Medida Ø	Unidades Caja	PRECIO UD.
TRL-01	Rojo 1/2"	90	0,77
TRL-02	Azul 1/2"	90	0,77



Casquillos reductores

Referencia	Medida Ø	Unidades Caja	PRECIO UD.
CR-01	40-32	550	0,48
CR-03	50-32	360	0,66
CR-02	50-40	375	0,69

Manguito deslizante encolar Hembra - Hembra



Referencia	Medida Ø	Unidades Caja	PRECIO UD.
MDE-01	32	350	0,62
MDE-02	40	200	0,71
MDE-03	50	180	0,79
MDE-04	75	64	1,48
MDE-05	90	45	2,18
MDE-06	110	54	2,40
MDE-07	125	36	3,36
MDE-08	160	16	5,01
MDE-09	200	9	12,41
MDE-10	250	1	28,20
MDE-11	315	1	88,03
MDE-12	400	1	226,09
MDE-13	500	1	550,61

Manguito deslizante con juntas dilatadoras



Referencia	Medida Ø	Unidades Caja	PRECIO UD.
MDJ-01	32	100	2,28
MDJ-02	40	175	2,52
MD-03	50	100	2,92
MDJ-04	75	90	4,64
MDJ-05	90	70	5,53
MDJ-06	110	45	6,94
MDJ-07	125	32	8,33
MDJ-08	160	8	25,16
MDJ-09	200	2	53,96

Válvulas antirretorno encolar

Referencia	Medida Ø	Unidades Caja	PRECIO UD.
VAT-110	110	1	151,62
VAT-125	125	1	152,90
VAT-160	160	1	236,61
VAT-200	200	1	424,28



Derivación Macho - Hembra Reducida 45°

Referencia	Medida Ø	Unidades Caja	PRECIO UD.
DMR-118	110-50	14	8,17



Derivación Doble Macho - Hembra Reducida 45°

Referencia	Medida Ø	Unidades Caja	PRECIO UD.
DMR-119	110-50-50	10	9,55



Manguito alargadera Hembra - Macho con derivación 90° y tope interior

Referencia	Medida Ø		L 2	L 3	L	Unidades Caja	PRECIO UD.	
	H Ø a	M Ø b						
MAD-01	90	90	40	142	71	213	24	6,97
MAD-02	110	110	50	142	71	213	18	7,61
MAD-03	125	125	50	170	80	250	14	13,98



Manguito Macho - Hembra 2 tomas 90°

Referencia	Medida Ø		L 2	L 3	L	Unidades Caja	PRECIO UD.	
	H Ø a	M Ø b						
MAD-10	110	110	50	164	70	234	12	13,38



Manguito Hembra - Macho alargadera de reparación y prolongador bote sifónico.

Referencia	Medida Ø			L 2	L 3	L	Unidades Caja	PRECIO UD.
	H Ø a	M Ø b	M Ø s					
MA-04	90	90	142	71	213	24	6,83	
MA-05	110	110	142	71	213	18	7,04	
MA-06	125	125	160	70	240	30	5,73	
MA-09	160	160	180	61	250	4	19,01	



Manguito Hembra - Macho alargadera de reparación con junta goma

Referencia	Medida Ø			L 2	L 3	L	Unidades Caja	PRECIO UD.
	H Ø a	M Ø b	M Ø s					
MA-106	125	125	160	70	240	22	8,79	



Manguito reductor Hembra - Hembra alargadera de reparación

Referencia	Medida Ø			L 2	L 3	L	Unidades Caja	PRECIO UD.
	H Ø a	H Ø b	M Ø s					
MA-03	125	110	160	70	240	30	5,98	



**Manguito reductor Hembra - Hembra
alargadera de reparación
con junta de goma**

Referencia	Medida Ø					Unidades Caja	PRECIO UD.
	H	H	L 2	L 3	L		
MA-103	125	110	160	70	240	28	8,79



**Ampliación excéntrica
Macho - Hembra**



Referencia	Medida Ø	Unidades Caja	PRECIO UD.
REE-01	40-32	220	0,56
REE-02	50-32	160	0,62
REE-03	50-40	140	0,66
REE-04	75-50	100	1,71
REE-05	90-50	64	1,72
REE-06	90-75	72	1,81
REE-07	110-75	45	1,97
REE-08	110-90	45	2,02
REE-09	125-75	32	2,56
REE-10	125-90	32	2,54
REE-11	125-110	32	1,91
REE-12	160-110	40	4,24
REE-13	160-125	40	4,47
REE-17	200-125	8	11,39
REE-14	200-160	20	11,75
REE-15	315-250	8	30,30
REE-16	250-200	6	76,07
REE-20	315-200	1	133,18
REE-18	400-315	1	468,65

**Reducción concéntrica
Hembra - Macho**



Referencia	Medida Ø	Unidades Caja	PRECIO UD.
RC-12	75-50	48	8,17
RC-01	90-75	48	3,02
RC-02	110-75	36	3,05
RC-03	110-90	36	3,02
RC-13	125-90	24	12,09
RC-04	125-110	24	3,26
RC-05	*145-110	16	3,67
RC-06	*125-125	16	3,67
RC-07	160-110	12	3,95
RC-08	160-215	16	3,81
RC-09	200-160	6	12,65
RC-10	200-125	6	12,65
RC-11	250-200	2	82,25
RC-15	315-250	1	128,17
RC-16	400-315	1	337,29

* REDUCCIONES INDICADAS PARA LA UNIÓN DE FIBROCEMENTO A PVC

**Reducción excéntrica
Hembra - Macho**



Referencia	Medida Ø	Unidades Caja	PRECIO UD.
AEX-12	90-75	48	2,22
AEX-13	110-90	40	2,41
AEX-16	125-110	24	2,48
AEX-19	200-125	2	34,51
AEX-18	200-160	10	28,75

ENTRA EN EL INTERIOR DEL TUBO SIN NECESIDAD DE ABOCARDAR
 IT IS INTRODUCED INTO THE TUBE WITHOUT FLARING
 EST INTRODUIT DANS LE TUBE SANS TORCHAGE

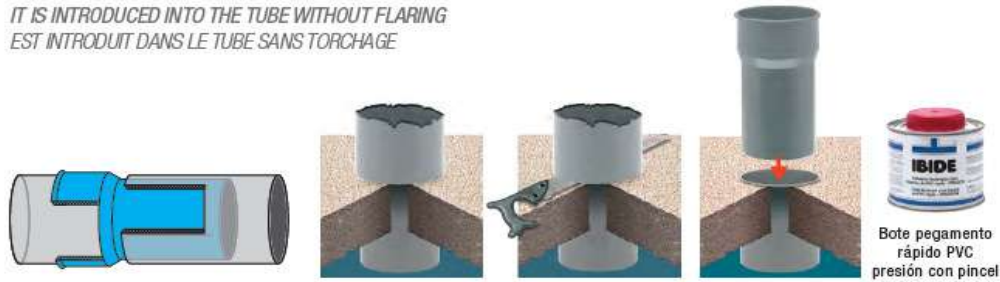

Bote pegamento rápido PVC presión con pincel

Manguito alargadera H-M (Interior)
 Válido para tubería Serie B y BD
 Reparación



Referencia	Medida Ø					Unidades Caja	PRECIO UD.
	H Ø a	M Ø b	L 2	L 3	L		
MA-11	75	68	65	163	239	16	9,73
MA-10	90	82	62	168	239	16	7,11
MA-07	110	103	65	162	239	16	6,47
MA-08	125	117	62	164	239	10	6,91
MA-13	160	152	88	196	289	10	23,55
MA-12	200	190	108	214	352	5	60,84

Tapón reducido Macho
 Doble Tapado (Interior tubo) Ø110
 Double reducer plug (M, covered)
 Tampon de reduction double (M, couvert)
 1 accesorio 3 funciones
 Tapon Simple
 Tapón Doble.
 Tapón Ciego.



Tapón reducido Macho
 Doble Abierto (interior tubo) Ø110
 Double reducer plug (M)
 Tampon de reduction double (M)



Referencia	Medida Ø	Unidades Caja	PRECIO UD.
TTI-60	103-50-40	90	2,16
TTI-61	103-40-40	90	2,16

Referencia	Medida Ø	Unidades Caja	PRECIO UD.
TDI-60	103-50-40	90	2,13
TDI-61	103-40-40	90	2,13

Manguito reparación M (interior tubo) - H Ø 40
 Coupling inverted reducer for repair pipes F Ø40-M (inner pipe)
 Manchon de tuyau pour reparation F Ø40 - M (tube intérieur)



Referencia	Medida Ø	Unidades Caja	PRECIO UD.
RA-40	40	90	1,71

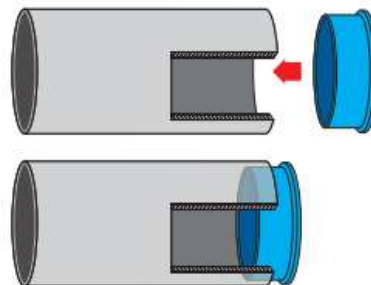

Válvulas antirretorno PVC
 encolar con muelle



















REFERENCIA	Ø	UN	€
49005	40	18	17,36
49006	50	18	18,47
49007	63	10	27,38
49008	75	4	60,24
49009	90	3	83,08
49010	110	3	91,40

Válvulas antirretorno PVC
 roscar con muelle



REFERENCIA	Ø	UN	€
49105	1 ¼"	18	18,91
49106	1 ½"	18	20,25
49107	2"	10	29,82
49108	2 ½"	4	66,47
49109	3"	3	91,40
49110	4"	3	101,78

RIEGO

	<p>ENCHUFE RAPIDO rosca hembra</p> <table border="1"> <thead> <tr> <th>REFERENCIA</th> <th>MEDIDA</th> <th>UN</th> <th>PRECIO</th> </tr> </thead> <tbody> <tr> <td>E - 4400</td> <td>3/4"</td> <td>100</td> <td>0,60 €</td> </tr> <tr> <td>E - 4401</td> <td>1/2"</td> <td>100</td> <td>0,60 €</td> </tr> <tr> <td>E - 4402</td> <td>1"</td> <td>50</td> <td>0,72 €</td> </tr> </tbody> </table>	REFERENCIA	MEDIDA	UN	PRECIO	E - 4400	3/4"	100	0,60 €	E - 4401	1/2"	100	0,60 €	E - 4402	1"	50	0,72 €		<p>ENCHUFE RAPIDO rosca macho</p> <table border="1"> <thead> <tr> <th>REFERENCIA</th> <th>MEDIDA</th> <th>UN</th> <th>PRECIO</th> </tr> </thead> <tbody> <tr> <td>E - 4410</td> <td>3/4"</td> <td>100</td> <td>0,60 €</td> </tr> <tr> <td>E - 4411</td> <td>1/2"</td> <td>100</td> <td>0,60 €</td> </tr> </tbody> </table>	REFERENCIA	MEDIDA	UN	PRECIO	E - 4410	3/4"	100	0,60 €	E - 4411	1/2"	100	0,60 €
REFERENCIA	MEDIDA	UN	PRECIO																												
E - 4400	3/4"	100	0,60 €																												
E - 4401	1/2"	100	0,60 €																												
E - 4402	1"	50	0,72 €																												
REFERENCIA	MEDIDA	UN	PRECIO																												
E - 4410	3/4"	100	0,60 €																												
E - 4411	1/2"	100	0,60 €																												
	<p>ENCHUFE RAPIDO c/abrazadera</p> <table border="1"> <thead> <tr> <th>REFERENCIA</th> <th>MEDIDA</th> <th>UN</th> <th>PRECIO</th> </tr> </thead> <tbody> <tr> <td>E - 4425</td> <td>20 mm</td> <td>50</td> <td>1,87 €</td> </tr> <tr> <td>E - 4426</td> <td>26 mm</td> <td>25</td> <td>2,42 €</td> </tr> </tbody> </table>	REFERENCIA	MEDIDA	UN	PRECIO	E - 4425	20 mm	50	1,87 €	E - 4426	26 mm	25	2,42 €		<p>MANGUITO UNION RAPIDA</p> <table border="1"> <thead> <tr> <th>REFERENCIA</th> <th>UN</th> <th>PRECIO</th> </tr> </thead> <tbody> <tr> <td>E - 4430</td> <td>50</td> <td>0,88 €</td> </tr> </tbody> </table>	REFERENCIA	UN	PRECIO	E - 4430	50	0,88 €										
REFERENCIA	MEDIDA	UN	PRECIO																												
E - 4425	20 mm	50	1,87 €																												
E - 4426	26 mm	25	2,42 €																												
REFERENCIA	UN	PRECIO																													
E - 4430	50	0,88 €																													
	<p>DERIVACION en Y</p> <table border="1"> <thead> <tr> <th>REFERENCIA</th> <th>UN</th> <th>PRECIO</th> </tr> </thead> <tbody> <tr> <td>E - 4431</td> <td>25</td> <td>2,01 €</td> </tr> </tbody> </table>	REFERENCIA	UN	PRECIO	E - 4431	25	2,01 €		<p>DERIVACION en Y con LLAVES</p> <table border="1"> <thead> <tr> <th>REFERENCIA</th> <th>UN</th> <th>PRECIO</th> </tr> </thead> <tbody> <tr> <td>E - 4435/1</td> <td>20</td> <td>8,55 €</td> </tr> </tbody> </table>	REFERENCIA	UN	PRECIO	E - 4435/1	20	8,55 €																
REFERENCIA	UN	PRECIO																													
E - 4431	25	2,01 €																													
REFERENCIA	UN	PRECIO																													
E - 4435/1	20	8,55 €																													
	<p>CONECTOR</p> <table border="1"> <thead> <tr> <th>REFERENCIA</th> <th>MEDIDA</th> <th>UN</th> <th>PRECIO</th> </tr> </thead> <tbody> <tr> <td>E - 4450</td> <td>20 mm</td> <td>50</td> <td>2,26 €</td> </tr> <tr> <td>E - 4455</td> <td>26 mm</td> <td>25</td> <td>2,65 €</td> </tr> </tbody> </table>	REFERENCIA	MEDIDA	UN	PRECIO	E - 4450	20 mm	50	2,26 €	E - 4455	26 mm	25	2,65 €		<p>LANZA RIEGO 1" con enchufe rápido</p> <table border="1"> <thead> <tr> <th>REFERENCIA</th> <th>UN</th> <th>PRECIO</th> </tr> </thead> <tbody> <tr> <td>E - 4545</td> <td>25</td> <td>2,96 €</td> </tr> </tbody> </table>	REFERENCIA	UN	PRECIO	E - 4545	25	2,96 €										
REFERENCIA	MEDIDA	UN	PRECIO																												
E - 4450	20 mm	50	2,26 €																												
E - 4455	26 mm	25	2,65 €																												
REFERENCIA	UN	PRECIO																													
E - 4545	25	2,96 €																													
	<p>PISTOLA RIEGO c/enchufe rápido</p> <table border="1"> <thead> <tr> <th>REFERENCIA</th> <th>UN</th> <th>PRECIO</th> </tr> </thead> <tbody> <tr> <td>E - 4600</td> <td>10</td> <td>7,92 €</td> </tr> </tbody> </table>	REFERENCIA	UN	PRECIO	E - 4600	10	7,92 €		<p>LANZA RIEGO con portagoma (2 pasos)</p> <table border="1"> <thead> <tr> <th>REFERENCIA</th> <th>UN</th> <th>PRECIO</th> </tr> </thead> <tbody> <tr> <td>E - 4552</td> <td>25</td> <td>2,37 €</td> </tr> </tbody> </table>	REFERENCIA	UN	PRECIO	E - 4552	25	2,37 €																
REFERENCIA	UN	PRECIO																													
E - 4600	10	7,92 €																													
REFERENCIA	UN	PRECIO																													
E - 4552	25	2,37 €																													
	<p>ASPERSOR GEMINI con brazos móviles, con enchufe y portagomas</p> <table border="1"> <thead> <tr> <th>REFERENCIA</th> <th>UN</th> <th>PRECIO</th> </tr> </thead> <tbody> <tr> <td>E - 4640</td> <td>1</td> <td>17,24 €</td> </tr> </tbody> </table>	REFERENCIA	UN	PRECIO	E - 4640	1	17,24 €		<p>PISTOLA C/ROCIADOR MULTIF. c/enchufe rápido</p> <table border="1"> <thead> <tr> <th>REFERENCIA</th> <th>UN</th> <th>PRECIO</th> </tr> </thead> <tbody> <tr> <td>E - 4605/5</td> <td>10</td> <td>15,05 €</td> </tr> </tbody> </table>	REFERENCIA	UN	PRECIO	E - 4605/5	10	15,05 €																
REFERENCIA	UN	PRECIO																													
E - 4640	1	17,24 €																													
REFERENCIA	UN	PRECIO																													
E - 4605/5	10	15,05 €																													
	<p>MANGUITO REPARADOR</p> <table border="1"> <thead> <tr> <th>REFERENCIA</th> <th>MEDIDA</th> <th>UN</th> <th>PRECIO</th> </tr> </thead> <tbody> <tr> <td>E - 4480</td> <td>20 mm</td> <td>50</td> <td>1,52 €</td> </tr> <tr> <td>E - 4481</td> <td>26 mm</td> <td>25</td> <td>2,26 €</td> </tr> </tbody> </table>	REFERENCIA	MEDIDA	UN	PRECIO	E - 4480	20 mm	50	1,52 €	E - 4481	26 mm	25	2,26 €		<p>ASPERSOR OSCILANTE</p> <table border="1"> <thead> <tr> <th>REFERENCIA</th> <th>UN</th> <th>PRECIO</th> </tr> </thead> <tbody> <tr> <td>E - 4689</td> <td>1</td> <td>31,36 €</td> </tr> </tbody> </table>	REFERENCIA	UN	PRECIO	E - 4689	1	31,36 €										
REFERENCIA	MEDIDA	UN	PRECIO																												
E - 4480	20 mm	50	1,52 €																												
E - 4481	26 mm	25	2,26 €																												
REFERENCIA	UN	PRECIO																													
E - 4689	1	31,36 €																													
<p>PORTAMANGUERAS MURAL</p>  <p>PLASTICO</p> <table border="1"> <thead> <tr> <th>REFERENCIA</th> <th>UN</th> <th>PRECIO</th> </tr> </thead> <tbody> <tr> <td>4895</td> <td>10</td> <td>3,90 €</td> </tr> </tbody> </table>	REFERENCIA	UN	PRECIO	4895	10	3,90 €	<p>ALAMBRE PLASTIFICADO</p>  <table border="1"> <thead> <tr> <th>REFERENCIA</th> <th>UN</th> <th>PRECIO</th> </tr> </thead> <tbody> <tr> <td>356800</td> <td>10</td> <td>8,46 €</td> </tr> </tbody> </table>	REFERENCIA	UN	PRECIO	356800	10	8,46 €		<p>CARRO PORTAMANGUERAS de 50 metros 14x19 (1/2")</p> <table border="1"> <thead> <tr> <th>REFERENCIA</th> <th>UN</th> <th>PRECIO</th> </tr> </thead> <tbody> <tr> <td>4857</td> <td>1</td> <td>49,66 €</td> </tr> </tbody> </table>	REFERENCIA	UN	PRECIO	4857	1	49,66 €										
REFERENCIA	UN	PRECIO																													
4895	10	3,90 €																													
REFERENCIA	UN	PRECIO																													
356800	10	8,46 €																													
REFERENCIA	UN	PRECIO																													
4857	1	49,66 €																													

Aspersor Green Lawn

Aplicaciones

- Nuevo aspersor en versiones plástico y metal que cubre necesidades bajas y medias en el riego de jardines, zonas verdes y hortícolas aprovechando su gran versatilidad.

Aplicaciones

- Con boquilla tipo 5/12" (3,97 mm)
- Dotado de raso anti-salpicadura y cortachorro en el modelo metálico.
- Con regulación de alcance y cortachorro en el modelo plástico.
- Con ajuste fácil del sector de riego o círculo completo.
- Con rosca 1/2" BSP macho en ambos modelos.
- El modelo metálico construido en latón.
- El modelo plástico contruido en plástico de alto impacto. componentes metálicos en acero inoxidable.

Presión (Atm.)	Radio (m)	Caudal (L/min.)
1,00	8,80	10,22
1,75	11,00	13,25
2,45	11,75	15,90
3,15	12,50	17,80



MODELO	PRECIO
PLASTICO	4,88 €

Presión (Atm.)	Radio (m)	Caudal (L/min.)
1,00	-	-
1,75	11,50	12,85
2,45	11,90	15,50
3,15	12,25	17,80
3,50	12,50	18,90



MODELO	PRECIO
LATON	19,22 €



Pinchos Portaaspersor

MODELO	PRECIO
PLASTICO	3,41 €
LATON	8,53 €

Lanza manguera PITON



CODIGO	MEDIDA	UN	PRECIO
07922001432	16mm	6	7,86 €
0792001449	20mm	6	6,78 €
0792001456	25mm	6	10,76 €
0792001463	30mm	6	15,19 €
	35mm	6	30,93 €

Lanza manguera REGULABLE



CODIGO	MEDIDA	UN	PRECIO
905016	16mm	12	8,62 €
905020	20mm	12	8,98 €
905025	25mm	12	9,35 €

Manguera BLACK GARDEN



CODIGO	Ø (mm)		PRECIO
	Int.	Ext.	
40101521	15	20	2,48 €
40101525	19	25	3,81 €
40101533	25	32	8,50 €

01 - Capa negra y naranja anti-torsión.
02 - Capa refuerzo con malla poliéster
03 - Capa interior uso alimentario

Manguera de calidad superior, uso alimentario y dotada de sistema anti-UV, reforzada con hilo de poliéster resistente hasta 10 bar de presión. Especial para riegos de jardinería y embarcaciones.

Rollos de 50 metros



OFERTA
A partir de 6 rollos
Descuento 5%

Manguera CRISTAL



CODIGO	Ø (mm)		PRECIO
	Int.	Ext.	
26010710	7	10	1,06 €
26010812	8	12	1,09 €
26011014	10	14	1,86 €

RIEGO



Aspersor
intermitencia
**1/2" macho
con puntal
y enchufe
rápido**

con filtro

♂ 1/2

REFERENCIA	UN	PRECIO
4595	1	13,81 €



**Ducha de Jardín
con Trípode
con llave de paso y
enchufe rápido**

Con filtro

REFERENCIA	UN	PRECIO
4765	1	51,14 €

EXPOSITOR

GRANEL

Nº	Ref.	Descripción	Uds.
1	4400	Enchufe rápido 3/4" hembra	100
2	4401	Enchufe rápido 1/2" hembra	100
3	4402	Enchufe rápido 1" hembra	100
4	4410	Enchufe rápido 3/4" macho	100
5	4450	Conector abrazadera 20 mm.	50
6	4455	Conector abrazadera 26 mm.	50
7	4430	Manguito de unión rápida	100
8	4480	Manguito reparador 20 mm.	50
9	4481	Manguito reparador 26 mm.	50
10	4550	Lanza de riego con enchufe rápido	25
11	4552	Lanza de riego abrazadera 20 mm.	25
12	4553	Lanza de riego abrazadera 26 mm.	25

+ regalo

27.00.45	Expositor metálico HYPPO PLUS	1
34.98.04	Cesto expositor HYPPO PLUS	12
79.04.09	Cartel expositor ZEBRA SIROFLEX	1



No 179

ADAPTADOR GRIFO ROSCA HEMBRA



SISTEMA 15

CODIGO	MEDIDA	UN	PRECIO
515 00 015012	1/2"	12	5,61 €
515 00 015034	3/4"	12	5,61 €
515 00 015001	1"	12	8,54 €

SISTEMA 22

CODIGO	MEDIDA	UN	PRECIO
515 50 022034	3/4"	12	5,22 €
515 50 022001	1"	12	7,80 €

PORTAGOMAS ABIERTO



SISTEMA 15

CODIGO	MEDIDA	UN	PRECIO
515 02 015015	12 - 15	12	11,08 €
515 02 015019	15 - 19	12	13,15 €

SISTEMA 22

CODIGO	MEDIDA	UN	PRECIO
515 53 022022	15 - 19	12	16,36 €

UNION DE PORTAGOMAS



SISTEMA 15

CODIGO	UN	PRECIO
515 07 015015	12	3,90 €



ADAPTADOR HERRAMIENTAS ROSCA MACHO 3/4"

CODIGO	UN	PRECIO
515 01 01534	12	3,24 €

UNION REPARADORA



SISTEMA 15

CODIGO	MEDIDA	UN	PRECIO
515 06 015015	12 - 15	12	12,00 €
515 06 019019	15 - 19	12	9,75 €

LANZA REGULABLE



SISTEMA 15

CODIGO	UN	PRECIO
515 10 015000	6	9,98 €

SISTEMA 22

CODIGO	UN	PRECIO
515 55 022000	6	20,72 €

LANZA FIJA



SISTEMA 15

CODIGO	UN	PRECIO
515 11 015000	6	5,96 €

PISTOLA DE RIEGO REGULABLE LATON forro en PVC

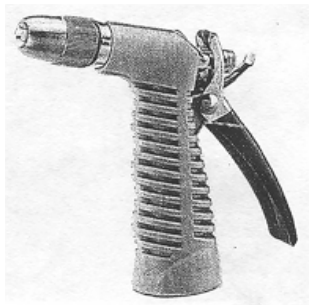

CODIGO
518 03 000002

UN	PRECIO
6	12,97 €

LANZA REGULABLE ALUMINIO Sistema 15 Long. 11,5



REFERENCIA
515 15 015001

UN	PRECIO
6	13,74 €

Ø 5,5cm

RIEGO POR GOTEO



Integrado Tandem DRIP

Características

NOVEDAD

- Tubo con el goteo integrado Ø 16 mm.
- Presión de trabajo 1 atm
- Ideal para setos, alibustres, flores, etc.
- Espesor 1,1 mm

CODIGO	ARTICULO	UN	€ metro
512253	25 m Pe 16, 2 l. integr. 0,33	25	0,61

Drip In PE 16 mm, 1,15 mm, autocomp. Marron

CODIGO	ARTICULO	UN	€ metro
515823	25 m Drip In PE 16 Autocomp. 0,33	25	0,78
515832	50 m Drip In PE 16 Autocomp. 0,33	100	0,69



MANGUERA PE



CODIGO	ARTICULO	UN	€ metro
536904	25 m Pe 16 negro	25	0,39
536908	50 m Pe 16 negro	50	0,36

Sacabocados multifunción

CODIGO	UN	€ Ud.
730046	1	13,82

- Caja de perforación de tuberías de P.E. en 12,16 y 20 mm
- Boquillas de punzonado en 3 y 4 mm
- Apéndice para la extracción de goteros



Gancho soporte manguera

CODIGO	Medida	UN	€ Ud.
440003	16 x 30	1000	0,08
440009	16 x 90	1000	0,12



CODIGO	ARTICULO	UN	€ Ud.
390416	Empalme con anillas 16 mm	100	0,20



CODIGO	ARTICULO	UN	€ Ud.
791616	Te c/ anillas 16 mm	100	0,34
791618	Te c/ anillas 16 x 1/2	100	0,41



CODIGO	ARTICULO	UN	€ Ud.
286516	Codo con anillas 16 mm	100	0,36



CODIGO	ARTICULO	UN	€ Ud.
391616	Enlace rosca Macho 1/2 x 16	100	0,22
391620	Enlace rosca Macho 3/4 x 16	100	0,22
391116	Enlace rosca Hembra 1/2 x 16	100	0,42
391125	Enlace rosca Hembra 3/4 x 16	100	0,48



CODIGO	ARTICULO	UN	€ Ud.
899716	Valvula VPP 16 x 16	100	0,87
899816	Valvula VMP 1/2 x 16	100	0,92
899817	Valvula VMP 3/4 x 16	100	0,92

No 181

TURBO SC® PLUS

Gotero autocomponente

Características

- Disponible en 2 l/h y 4 l/h
- Presión de trabajo de 1 a 4 bar
- Gotero desmontable
- Toma de 4 mm
- Laberinto de amplia sección que lo hace turbulento y resistente a la obstrucción
- Diafragma de silicona de alta calidad para mejorar la uniformidad de descarga
- Gotero de clase A según las normas UNI 9260
- Resistente al ácido hasta pH2

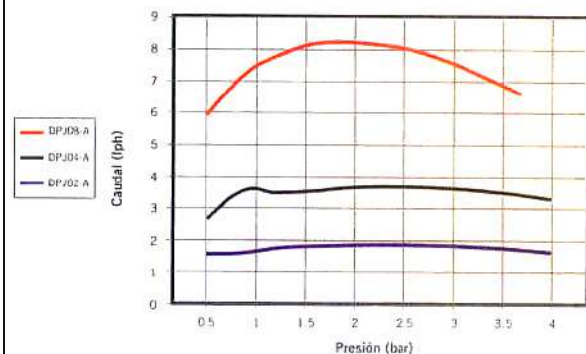

CODIGO	ARTICULO	UN	€ Ud.
461302	Gotero Turbo Plus 2 l/h USA	100	0,36
461304	Gotero Turbo Plus 4 l/h USA	100	0,36
461014	Gotero Regulable	100	0,12



Monofibre Bicapa 35 mm

El césped de alta gama que no necesita ningún tipo de relleno ya que tiene en su base un entramado de fibras que evita la compactación del césped sin necesidad de arena ni caucho.

El hecho de no necesitar relleno lo hace ideal para terrazas, piscinas, áticos, guarderías, restaurantes y en general para cualquier instalación que busque confort, elegancia y un césped siempre verde, sorprendentemente natural y prácticamente sin ningún mantenimiento.



CARACTERÍSTICAS DEL PRODUCTO

Aplicaciones	Paisajismo-Jardinería
Tipo de producción	Tufting en línea
Composición	100% polietileno
Color	Verde bitono
Estructura	Monofilamento
Número de hilos	8 + 8
Título del hilo	13.800 Dtex.
Galga	01/05/16
Peso del hilo (ISO 2060)	1.963 g/m ²
Altura del hilo	35 mm
Número de puntadas / dm	14 dm lineal
Número de puntadas / m ²	17.500 puntadas / m ²
Soporte base o backing	Doble capa Polipropileno
Peso backing	220 g/m ²
Peso del recubrimiento	500g/m ²
Composición del recubrimiento	Poliuretano
Peso total	2.685 g/m ²
Anchura total	2 m
Longitud de los rollos	25 m

Código	Artículo	Altura mm	Dext.	Nº puntos/m ²	Peso total gr / m ²	Dimensiones rollo		€/ m ²
						Ancho (m)	Largo (m)	
506420	Rismonofibre Bicapa 20mm	20	5400	14700	2570	2 m	25 m	17,93
506424	Rismonofibre Bicapa 20mm	20	5400	14700	2570	1 m	4 m	19,80
506430	Rismonofibre Bicapa 30mm	30	7200	14700	2870	2 m	15 m	25,72
506434	Rismonofibre Bicapa 30mm	30	7200	14700	2870	1 m	4 m	28,30
506440	Rismonofibre Bicapa 40mm	40	7200	19080	3970	2 m	15 m	37,60
506444	Rismonofibre Bicapa 40mm	40	7200	19080	3970	1 m	4 m	42,17

Código	Artículo	Ud / c	PRECIO
090485	Adhesivo PU Bicomponente	12 Kg	7,47 €/Kg
090480	Adhesivo PU Bicomponente	5 Kg	8,55 €/Kg
090405	Adhesivo PU Monocomponente	5 Kg	12,28 €/bote
080400	Adhesivo 500 mg	500 ml	16,57 €/m
506599	Geotextil 30 cm	100 mts	1,02 €/m
506530	Geotextil 30 cm	30 mts	2,03 €/m

A estos precios se incrementará el % de I.V.A correspondiente



DIFUSOR PS

- MODELOS**
 PS-00 - Adaptador 1/2" Fijo.
 PS-02 - Emergente 5 cm.
 PS-06 - Emergente 10 cm.

- ESPECIFICACIONES**
- Caudal: 0,05 a 1,20 m³/h; 0,8 a 20,1 l/min.
 - Radio: 3,0 a 5,8 m.
 - Presión: 1,4 a 2,8 bares; 1,2 a 275 kPa.

- DIMENSIONES**
- Altura total: PS-00 - 11 cm; PS-02 - 11 cm; PS-04 - 16 cm.
 - Conector: hembra 1/2".
 - Diámetro exterior: 3 cm.

MODELO	CODIGO	PRECIO
PS-02 (11 cm)	352017	4,36 €
PS-04 (16 cm)	354017	4,74 €

OFERTA
40 unidades
Descuento
5%

Modelo PS - Franja Lateral				
Boquilla			Color: Azul ●	
	Baros	kPa	m ³ /h	l/min
Modelo Ssa Franja Lateral	1,4	132	0,25	4,2
	1,7	172	0,27	4,5
	2,1	206	0,30	4,9
	2,4	241	0,32	5,3
	2,8	275	0,34	5,7
		l/min	Ancho (m) x Largo (m)	
		4,2	1,2 x 8,5	
		4,5	1,5 x 9,1	
		4,9	1,5 x 9,1	
		5,3	1,5 x 9,8	
		5,7	1,5 x 10,1	

PARÁMETROS DE FUNCIONAMIENTO

Sector	Presión	Radio: 3,0 m (10)			Radio: 3,7 m (12)			Radio: 4,6 m (15)			Radio: 5,2 m (17)			
		Baros	kPa	m	m ³ /h	l/min	m	m ³ /h	l/min	m	m ³ /h	l/min	m	m ³ /h
45°	1,4	132	3,0	0,05	0,8	5,7	0,09	1,5	4,3	0,09	1,3	4,9	0,20	3,4
	1,7	172	3,8	0,07	0,8	4,7	0,11	1,9	4,6	0,11	1,9	5,2	0,23	3,8
	2,1	206	3,4	0,07	1,1	4,1	0,11	1,9	4,9	0,14	2,3	3,5	0,25	4,2
	2,4	241	3,4	0,07	1,1	4,1	0,14	2,3	4,9	0,16	2,6	3,5	0,30	4,9
90°	1,4	132	3,7	0,07	1,1	4,6	0,16	2,6	5,2	0,16	2,6	5,8	0,32	5,3
	1,7	172	3,0	0,09	1,5	3,7	0,14	2,3	4,3	0,16	2,6	4,9	0,36	6,1
	2,1	206	3,4	0,11	1,9	4,1	0,20	3,4	4,9	0,23	3,8	5,5	0,43	7,2
	2,4	241	3,4	0,11	1,9	4,1	0,20	3,4	4,9	0,25	4,2	5,5	0,48	7,9
120°	1,4	132	3,7	0,11	1,9	4,6	0,23	3,8	5,2	0,27	4,5	5,8	0,50	8,3
	1,7	172	3,0	0,14	2,3	3,7	0,20	3,4	4,6	0,25	4,2	5,2	0,43	7,2
	2,1	206	3,4	0,14	2,3	4,1	0,23	3,8	4,9	0,27	4,5	5,5	0,48	7,9
	2,4	241	3,4	0,16	2,6	4,5	0,25	4,2	4,9	0,30	4,9	5,5	0,52	8,7
180°	1,4	132	3,7	0,16	2,6	3,7	0,27	4,5	4,3	0,32	5,3	4,9	0,55	9,1
	1,7	172	3,0	0,18	3,0	3,7	0,30	4,9	4,6	0,36	6,1	5,2	0,61	10,2
	2,1	206	3,4	0,23	3,8	4,1	0,34	5,7	4,9	0,41	6,8	5,5	0,66	11,0
	2,4	241	3,4	0,23	3,8	4,3	0,36	6,1	4,9	0,45	7,6	5,5	0,70	11,7
240°	1,4	132	3,7	0,27	4,5	4,6	0,39	6,4	5,2	0,48	7,9	5,8	0,75	12,5
	1,7	172	3,0	0,25	3,8	3,7	0,34	5,7	4,3	0,39	6,4	4,9	0,59	9,8
	2,1	206	3,4	0,30	4,9	4,1	0,43	7,2	4,9	0,48	7,9	5,3	0,73	12,1
	2,4	241	3,4	0,32	5,3	4,3	0,48	7,9	4,9	0,52	8,7	5,5	0,80	13,2
270°	1,4	132	3,7	0,36	6,1	4,6	0,50	8,3	5,2	0,57	9,5	5,8	0,84	14,0
	1,7	172	3,0	0,25	4,2	3,7	0,39	6,4	4,3	0,45	7,6	4,9	0,64	10,6
	2,1	206	3,4	0,34	5,7	4,1	0,48	7,9	4,9	0,55	9,1	5,5	0,75	12,5
	2,4	241	3,4	0,36	6,1	4,3	0,52	8,7	4,9	0,59	9,8	5,5	0,89	14,8
360°	1,4	132	3,7	0,39	6,4	4,6	0,55	9,1	5,2	0,64	10,6	5,8	0,91	15,1
	1,7	172	3,0	0,32	5,3	3,7	0,48	7,9	4,3	0,68	11,4	4,9	0,84	14,0
	2,1	206	3,4	0,45	7,6	4,1	0,64	10,6	4,9	0,82	13,6	5,5	1,04	17,4
	2,4	241	3,4	0,48	7,9	4,3	0,68	11,4	4,9	0,91	15,1	5,5	1,09	18,2
	2,8	275	3,7	0,55	9,1	4,6	0,75	12,5	5,2	1,00	16,7	5,8	1,20	20,1

Los datos reflejados en las tablas se entienden para viento en calma. Corregir estos datos con factores de reducción para condiciones de viento.

El rendimiento óptimo se obtiene con una presión de 1,7 bars/172 kPa.

Los datos de funcionamiento provienen de ensayos conformes a la norma ASAE S398.1. Ver catálogo general, página 3, para normas ASAE completas.

RICHDEL 2400

TABLA DE PERDIDAS DE CARGA

m ³ /h	ΔH Bar	l/min.	ΔH Kpa
2,4	0,26	40	25,7
3,6	0,21	60	20,5
4,8	0,23	80	23,3
6,0	0,30	100	29,5
7,2	0,38	120	38,4

V240RMTF	Mod. 2400	F.C.	1" BSP
V240RMT	Mod. 2400	w/o F.C.	1" BSP

CARACTERÍSTICAS

- Válvulas solenoides 1" con regulador de caudal y sin regulador de caudal.
- Instalación en línea.
- Cuerpo fabricado en PVC resistente a la corrosión y rayos ultravioletas.
- Diafragma montado en acetal, acero inox. y goma de santoprene con doble lóbulo contra fugas de agua.
- Tapa roscada que permite un servicio fácil y rápido.
- Presión de trabajo: de 1,30 atm. a 10 atm.
- Solenoides encapsulado de 24 VAC. Corriente de arranque 0,40 Amp. Corriente de trabajo 0,20 Amp.



PRECIO
27,53 €



Características

- Modelos para 2, 4, 6 y 8 estaciones
- Programación "autoguiada" que dirige al usuario por los planes de riego
- Tapa abatible (modelo para interiores) para proteger la pantalla de LCD de gran tamaño
- 3 programas
- 3 horas de arranque para programas A y B. El programa C sólo ofrece una hora de arranque
- Programa C: Programa repetitivo ó bucle
- Tiempos de riego de 1 a 240 minutos
- Múltiples opciones de días de riego
- Calendario de 365 días
- Calendario de 7 días, intervalo de 14 días
- Riego en días impares/pares, con exclusión del día 31 de mes
- "Ajuste del porcentaje de agua por temporada" de 0 a 200% (en incrementos del 10%) Water Budget
- Arranque manual por estación o por programa
- Demora por lluvia incorporada con conexiones para los terminales de un sensor
- Fusible electrónico reajutable.
- Programación desde la "comodidad de su casa"
- Válvula maestra programable por programa
- Revisión de los programas



- Títulos superpuestos en varios idiomas: alemán, español, francés, inglés e italiano
- Retención de programas durante 5 años, con pila de botón
- Respaldo por pila en tiempo real (pila no incluida)
- "Rain off" programable hasta 7 días

CODIGO	MODELO	PRECIO
652204	4 ESTACIONES	108,48 €
652206	6 ESTACIONES	121,04 €

Características

- Dos diales o selectores giratorios para fijar el intervalo y la duración del riego
- Diez opciones para riego a intervalos (una vez, 2 horas, 4 horas, 8 horas, 12 horas, a diario, segundo día, tercer día, cuarto día, séptimo día)
- Diez opciones para duración de riego (ON, OFF; 2 min., 5 min., 10 min., 15 min., 30 min., 60 min., 90 min., 120 min.)
- Riego manual sin interrumpir el intervalo de riego
- Diseño resistente a la intemperie
- Diseño de válvula de funcionamiento seguro

Programador a pilas PT-1

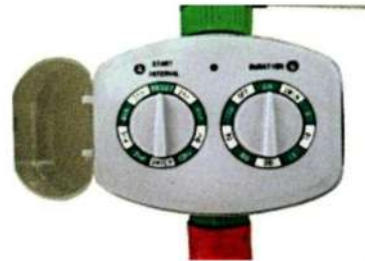

UN	PRECIO
6	56,47 €

Especificaciones

- 3 pilas alcalinas AAA 1,5 V
- Presión de trabajo de 1 a 5 bar
- Conexión para grifo 3/4" y 1"



R-430

Tabla de Rendimientos

N.º Boquilla	Presión (bar)	Radio (m)	Caudal (l/min)
0,75	2,0	6,1	3,0
	2,5	6,3	3,3
	3,0	6,5	3,8
	3,5	6,7	4,6
1.0	2,0	7,9	4,2
	2,5	8,1	4,6
	3,0	8,3	5,2
	3,5	8,6	5,7
1.5	2,0	8,8	4,5
	2,5	9,0	5,0
	3,0	9,3	5,6
	3,5	9,5	6,1
2.0	2,0	9,1	5,3
	2,5	9,3	6,0
	3,0	9,4	6,8
	3,5	9,4	7,7
3.0	2,0	10,3	8,7
	2,5	10,6	9,4
	3,0	10,7	10,4
	3,5	10,7	11,5

CODIGO	PRECIO
115643	16,93 €



TABLA DE RENDIMIENTOS

Boquilla	N.º	Presión (bar)	Radio (m)	Caudal (l/min)
2,1	1	1,8	1,1	0,8
	2	2,2	1,3	1,0
	3	2,6	1,5	1,2
	4	3,0	1,7	1,4
2,8	1	2,2	1,3	1,0
	2	2,8	1,6	1,3
	3	3,4	1,9	1,6
	4	4,0	2,2	1,9
3,5	1	2,8	1,6	1,3
	2	3,5	2,0	1,7
	3	4,2	2,4	2,1
	4	5,0	2,8	2,5
4,2	1	3,5	2,0	1,7
	2	4,2	2,4	2,1
	3	5,0	2,8	2,5
	4	6,0	3,4	3,0

CR-500

CODIGO	PRECIO
115650	22,68 €

Para 12 unidades 5% de descuento

ARQUETAS

Características:

- Antirrobo
- Anticorrosión
- Cierre con tornillo inoxidable
- Tapa de color verde
- Fabricada en Polipropileno de gran resistencia



MOD. 1220

"JUMBO"



MOD. 1100

"LARGE"

MOD. 1419

"STANDARD"



Base	Tapa	Altura
270 x 230	175 x 210	180

PRECIO
10,08 €



Base	Tapa	Altura
420 x 320	340 x 245	200

PRECIO
19,63 €

Base	Tapa	Altura
650 x 530	550 x 415	300

PRECIO
54,84 €

TE COLECTOR



Características:

- Colector con derivación para la instalación rápida de las válvulas sin empleo de teflón.
- La junta tórica permite colocar la válvula de forma fácil y hermética.
- Disponible en 1".

PRECIO
3,07 €

COLECTORES SERIE PROFESIONAL



MODELO	ARTICULO	PRECIO
292102	2 salidas	8,46 €
292103	3 salidas	17,90 €
292104	4 salidas	22,93 €

BOBINAS



Características:

- Para utilizar con difusores y borboteadores. Se enrosca fácilmente a la entrada y se corta a la altura deseada.
- Tres modelos: 1/2" 1/2"-3/4" 3/4"

MEDIDA	PRECIO
1/2"	0,41 €
1/2" - 3/4"	0,45 €
3/4"	0,50 €

No 185

29/09/2022

ABRAZADERAS



**Abrazaderas
P.V.C.
para tubos
de cobre**

CODIGO	MEDIDA	UN	PRECIO
AP-01	Ø 12	50	0,22 €
AP-02	Ø 15	50	0,26 €
AP-03	Ø 18	50	0,27 €
AP-04	Ø 22	50	0,29 €
AP-05	Ø 28	50	0,31 €



**Abrazaderas
P.V.C.
para
evacuación**

CODIGO	MEDIDA	UN	PRECIO
AP-06	Ø 32	50	0,31 €
AP-07	Ø 40	50	0,32 €
AP-08	Ø 50	50	0,40 €
AP-10	Ø 75	200	0,73 €
AP-11	Ø 90	130	0,81 €
AP-12	Ø 110	75	0,89 €
AP-13	Ø 125	60	1,04 €

CLIPS CIERRE NYLON GRIS



DIAMETRO			UN	PRECIO
Ø	mm	"		
12	11-12	1/4	100	0,20 €
15	14-15		100	0,24 €
16	16-17	3/8	100	0,25 €
18	18-19		100	0,26 €
20	20-21	1/2	100	0,29 €
22	22-23		100	0,30 €
25	24-25		100	0,33 €
28	27-28		100	0,40 €
32	31-32	1	50	0,47 €
35	34-35		50	0,51 €
37	37-38		50	0,53 €
40	40-41		50	0,61 €
42	42-43	1¼	50	0,62 €
47	47-18	1½	50	0,64 €



CINTA PERFORADA

10 METROS

**GALVANIZADA
17 x 0,70**

CODIGO	MODELO	PRECIO
PV401708	GALVANIZADA	6,26 €
	INOX	25,06 €

ABRAZADERAS METALICAS

ABRAZADERA M-6

ZINCADO BICROMATADO
ROSCA M-6 x 100



CODIGO	Ø	ENVASE	PRECIO
AB110010	10	100	0,16 €
AB110012	12	100	0,16 €
AB110014	14	100	0,16 €
AB110015	15	100	0,17 €
AB110016	16	100	0,17 €
AB110018	18	100	0,17 €
AB110020	20	100	0,18 €
AB110022	22	100	0,18 €
AB110025	25	100	0,19 €
AB110026	26	100	0,20 €
AB110028	28	100	0,20 €
AB110030	30	100	0,24 €
AB110032	32	50	0,24 €
AB110035	35	50	0,26 €
AB110037	37	50	0,28 €
AB110042	42	50	0,30 €
AB110047	47	50	0,33 €

ABRAZADERA M-8

109075	75	50	0,67 €
109090	90	50	0,72 €
109110	110	50	1,12 €
109125	125	25	1,46 €
109160	160	25	1,33 €

ABRAZADERA DOBLE M-6

ZINCADO BICROMATADO
ROSCA M-6 x 100



CODIGO	Ø	ENVASE	PRECIO
AB210012	10 12	50	0,25 €
AB210015	14 - 15	50	0,27 €
AB210018	18	50	0,29 €
AB210022	22	50	0,33 €
AB210028	28	50	0,42 €

TORNILLO



CODIGO	Ø	ENVASE	PRECIO
AC120630	M 6 x 30	100	0,05 €
AC120640	M 6 x 40	100	0,08 €
AC120840	M 8 x 40	100	0,12 €

ABRAZADERA PUZZLE INOX con tornillo AISI 316

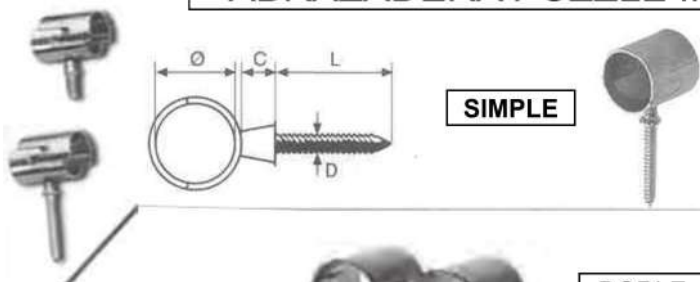

SIMPLE

DOBLE

CODIGO	Ø	ENVASE	PRECIO
319171412	12	100	0,76 €
0451006050	15	90	0,77 €
	18	40	0,81 €
0451006074	22	40	1,55 €
0451006080	28	20	1,65 €

No 187



CODIGO	Ø	ENVASE	PRECIO
0001023641	15	30	3,04 €
0001023659	18	25	3,43 €
0001023664	22	15	4,29 €

ABRAZADERAS

ABRAZADERA NYLON CON TORNILLO



Ø	ENVASE	PRECIO
12	100	0,32 €
14	100	0,38 €
16	100	0,43 €
18	100	0,58 €
20	100	0,59 €
22	100	0,60 €
25	100	1,16 €
28	100	1,18 €

ABRAZADERA NYLON DOBLE CON TORNILLO



Ø	ENVASE	PRECIO
12	100	0,52 €
14	100	0,54 €
16	100	0,56 €
18	100	0,55 €
20	100	0,86 €
22	100	0,92 €
28	25	1,57 €

ABRAZADERA FIX-RING



Ø	ENVASE	PRECIO
16	100	0,21 €
20	100	0,23 €



Ø	ENVASE	PRECIO
16	100	0,25 €
20	100	0,29 €

CLIP SIMPLE M-6



CARACTERISTICAS:
Casquillo latón M - 6
Material: Copolímero
Temperatura máxima admisible: 146 °C
Temperatura máxima recomendable: 102 °C

Ø	ENVASE	PRECIO
12	100	0,20 €
14 - 15	100	0,22 €
16 - 18	100	0,25 €
20 - 22	100	0,26 €
28	100	0,34 €
35	100	0,57 €
42	100	0,67 €

CLIP DOBLE M-6



Ø	ENVASE	PRECIO
8	100	0,33 €
10	100	0,33 €
12	100	0,35 €
14 - 15	100	0,37 €
16 - 18	100	0,45 €
20 - 22	100	0,48 €
28	100	0,65 €

ABRAZADERAS

132 ABRAZADERA ISOFONICA ABIERTA M-8

Ref.	DIAMETRO			UN	PRECIO
	Ø	mm	"		Ud.
132015	15	13-17	1/4	50	1,02 €
132018	18	17-19	3/8	50	1,05 €
132022	22	22-26	1/2	50	1,10 €
132028	28	32-35	3/4	50	1,13 €
132035	35	39-44	1	50	1,23 €
132042	42	47-51	1¼	25	1,27 €
132048	48	50-54	1½	25	1,43 €
132054	54	59-64		25	1,57 €
132060	60	59-64	2	25	1,70 €
132075	75	73-80	2½	25	1,97 €
132090	90	87-92	3	25	1,97 €
132100	100	99-105	3½	25	2,15 €
132110	110	108-112		25	2,28 €
132125	125	123-130	4	25	3,65 €
132160	160	155-168		25	5,92 €



134

ABRAZADERA ISOFONICA M-6

Ref.	DIAMETRO			PRECIO
	Ø	"	UN	Ud.
134012	12	1/4	100	0,25 €
134014	14-15		100	0,27 €
134016	16	3/8	100	0,27 €
134018	18		100	0,27 €
134020	20	1/2	100	0,28 €
134022	22		100	0,32 €
134026	26	3/4	100	0,35 €
134028	28		100	0,37 €
134032	32	1	50	0,38 €
134035	35		50	0,43 €
134042	42	1¼	50	0,53 €
134048	48	1½	50	0,57 €
134054	54		25	0,63 €
134060	60	2	25	0,67 €



135

ABRAZADERA DOBLE ISOFONICA M-6

Ref.	DIAMETRO			PRECIO
	Ø	"	UN	Ud.
135012	12	1/8	50	0,48 €
135014	14-16	1/4	50	0,55 €
135018	18	3/8	50	0,63 €
135022	22	1/2	50	0,72 €
135028	28	3/4	50	0,91 €



126

SOPORTE DOBLE M-8

Ref.	mm	UN	PRECIO
			100 Ud.
126050	50 - 95	50	120,75 €





fischer SX

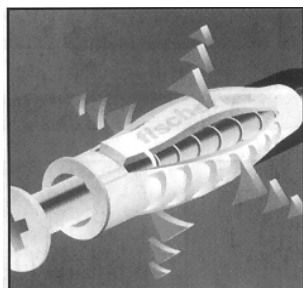

Expansión cuádruple

La nueva expansión cuádruple garantiza la máxima resistencia

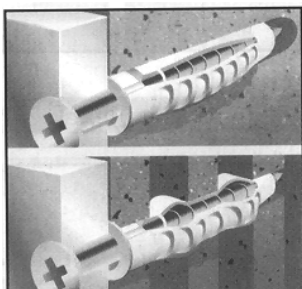

Campo de aplicación

El taco fischer SX se puede emplear en cualquier material, ya sea macizo o hueco.

Ø	UN	PRECIO
		CAJA
4	200	9,29 €
5	100	5,00 €
6	100	6,83 €
8	100	10,20 €
10	50	10,14 €
12	25	8,17 €
14	20	12,54 €

PLUSX 4,8

TACO PLASTICO

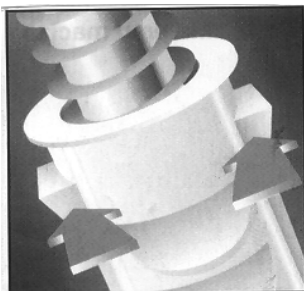

Eficaz resalte antigiro

El robusto resalte antigiro sujeta firmemente el taco al iniciar el atornillado

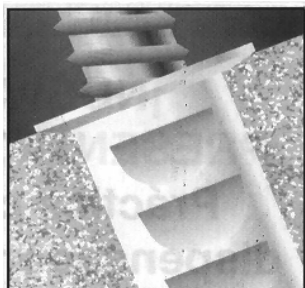

Reborde exterior

El marcado reborde del taco impide que éste se cuele dentro del taladro



Ø	UN	PRECIO
4	1000	0,02 €
5	1000	0,02 €
6	1000	0,02 €
8	1000	0,03 €
9	1000	0,03 €
10	500	0,05 €
12	500	0,08 €

VARILLA ROSCADA



ZINCADA

MEDIDA	UN	PRECIO
M-6 x 1000	10	0,78 €
M-8 x 1000	10	1,30 €
M-10 x 1000	10	1,90 €

INOX

MEDIDA	UN	PRECIO
M-6 x 1000	10	3,44 €
M-8 x 1000	10	5,55 €

MANGUITO SEPARADOR



MEDIDA	UN	PRECIO
M-6 x 30	100	0,27 €
M-8 x 20	100	0,25 €
M-8 x 30	100	0,29 €
M-10 x 30	100	0,48 €

ALCAYATAS PARA CALENTADORES



Juego 2 unidades

INOX	MEDIDA	UN	PRECIO
	8 X 65	50	1,08 €
8 X 60	50	1,67 €	

28/09/2022

**GRAPA**

mm	PULGADAS	ENVASE	PRECIO / UD.	
			SENCILLA	PUENTE
10	1/8	100	0,05 €	0,10 €
12		100	0,06 €	0,11 €
14	¼	100	0,08 €	0,13 €
16		100	0,08 €	0,14 €
18	3/8	100	0,08 €	0,15 €
20		100	0,10 €	0,16 €
22	½	100	0,10 €	0,17 €
25		100	0,11 €	0,17 €
26	¾	100	0,12 €	0,18 €
28		100	0,12 €	0,18 €
30		100	0,13 €	0,20 €
32	1	100	0,20 €	0,21 €
37		100	0,21 €	0,22 €
40		100	0,22 €	0,30 €
42	1 ¼	100	0,23 €	0,31 €

**BRIDA NYLON**

DIMENSIONES		DIAMETRO APERTURA	RESISTENCIA KG	PRECIO / UD.	
ANCHO	LONGITUD			ENVASE	
2,6	200	50	13	100	0,03 €
3,6	200	50	22	100	0,03 €
4,8	200	50	22	100	0,05 €
4,8	250	50	22	100	0,05 €
4,8	290	50	22	100	0,06 €
4,8	360	103	22	100	0,07 €
7,8	180	44	8	100	0,08 €
7,8	300	80	55	100	0,12 €
7,8	365	100	55	100	0,14 €
9	360	115	55	100	0,29 €
9	510	160	77	100	0,31 €

Tornillo sujeta-bridas

PERNO Ø 8	100	0,05 €
-----------	-----	--------



TORNILLO (4,8 x 38) DIN 7981	100	0,05 €
------------------------------	-----	--------

Diámetro interior	Unidades	PRECIO
Ø 8 - 16 mm	200	0,98 €
Ø 12 - 22 mm	200	1,05 €
Ø 16 - 27 mm	200	1,07 €
Ø 20 - 32 mm	200	1,10 €
Ø 25 - 40 mm	100	1,12 €
Ø 35 - 50 mm	100	1,17 €
Ø 40 - 60 mm	100	1,20 €
Ø 50 - 70 mm	100	1,22 €
Ø 60 - 80 mm	100	1,28 €
Ø 70 - 90 mm	50	1,32 €
Ø 80 - 100 mm	50	1,32 €
Ø 90 - 110 mm	50	1,38 €
Ø 100 - 120 mm	50	1,43 €
Ø 110 - 130 mm	50	1,47 €

ABRAZADERA SIN FIN INOXIDABLE

Acero Inoxidable
Espesor 0,8 mm
Anchura 10 mm
Tornillo M-6 x 20 mm. Cabeza Philips

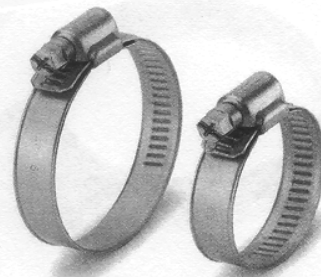

Referencia	Diametro x Longitud	Unidades	PRECIO
AN210458	M-6 x 45 Ø 8	200	0,32 €
AN210608	M-6 x 60 Ø 8	200	0,35 €
AN216010	M-8 x 60 Ø 10	100	0,51 €
AN218010	M-8 x 80 Ø 10	100	0,57 €
AN217014	M-10 x 70 Ø 14	100	0,81 €
AN211014	M-10 x 100 Ø 14	50	0,97 €
AN218016	M-12 x 80 Ø 16	25	1,22 €

ANCLAJE TORNILLO

Acero Carbonatado 4.8 Bicromatado
Arandela plana DIN 9021
Tornillo DIN 933
Expansión de la camisa interior

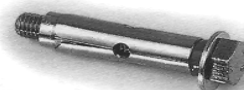

Diámetro	Tornillo x Longitud x Broca	Unidades	PRECIO
M-6 x 45	Ø 9	50	0,33 €
M-6 x 60	Ø 11	100	0,37 €
M-8 x 80	Ø 11	100	0,50 €
M-10 x 70	Ø 14	100	0,83 €
M-10 x 100	Ø 14	50	0,88 €

ANCLAJE ESPARRAGO

Acero Carbonatado 4.8 Bicromatado
Arandela plana DIN 9021
Expansión de la camisa interior



HOJAS SIERRAS DE MANO



Ref. HFC Carbón - Flex: acero al carbono

- Hoja de acero al carbono, económica, adecuada para el corte de materiales de poca dureza: aluminio, cobre, plástico...
- Irrompible en condiciones normales, resistente al desgaste.
- Recomendada para instalaciones, montadores, construcción y bricolaje.
- Disponible en doble corte.

Ref. HM2 Bi-metal: HSS flexible

- Hoja fabricada con dos tipos de acero: el filo de corte en acero súper rápido al molibdeno, y el dorso, flexible con acero de resorte par soportar cargas y evitar roturas.
- Elevado rendimiento: combina la más alta eficacia de corte con una increíble resistencia al desgaste,
- Recomendada para todo tipo de materiales.

CODIGO	ARTICULO	UN	PRECIO
HFC24	HOJA SIERRA SIMPLE 24 D/P M300x12x0,6	100	0,38 €
HCFDC24	HOJA SIERRA DOBLE 24 D/P M300x25x0,6	50	0,85 €
0825087344	HOJA SIERRA SIMPLE HSS	100	6,15 €

Abrazadera reforzada M8+M10 Inox AISI 316 / 4A



Referencia	Ø	UN	PRECIO/UD
4370180000	18 3/8	50	2,7749 €
4370220000	22 1/2	50	2,9713 €
4370280000	28 3/4	50	3,1929 €
4370350000	35 1	50	3,3897 €
4370420000	42 1 1/4	50	3,6202 €

Tornillo doble rosca Inox 304 / A2



Referencia	Ø	UN	PRECIO/UD
4410850000	M8x50	100	0,8026 €

SOPLETES Y BOTELLAS DE GAS

Soplete KT747



Potente soplete para soldadura fuerte.
Encendido piezoeléctrico.
Bloqueo de llama.
Temperatura de llama hasta 2400 °C.
Boquilla efecto dardo reemplazable.
Permite el trabajo en posición invertida.

REFERENCIA	MODELO	UN	PRECIO
I31G990002	Kit Soplete KT747 + 2 Botellas Gas Map Pro	6	108,60 €



BOTELLA GAS MAP-PRO

Características:

Botella desechable.
Conexión USA.
Casco metálico.
Contenido 0,4 kg. a 30 bar.

REFERENCIA	MODELO	UN	PRECIO
I31G900000	BOTELLA GAS MAP-PRO	12	14,90 €



SOPLETE KT 747

Características:

Soplete con sistema de llama turbo envolvente.
Cuerpo metálico.
Encendido piezoeléctrico.
Válido para soldadura blanda, hasta 35 mm., y soldadura fuerte, hasta 22 mm.
Con grifo para regulación de intensidad la llama.
Pulsador para trabajo continuo con intensidad de llama.
Permite trabajar con el soplete y la botella invertidos, sin apagarse.



KT-717

Encendido manual.
Regulador de llama.
Temp. de llama hasta 1.800°C
Soplete para soldadura fuerte.
Permite trabajar en posición invertida.
Botella: Map Pro (I31G900000)

REFERENCIA	MODELO	UN	PRECIO
I31G000747	SOPLETE KT-747 Piezoeléctrico	6	89,68 €
I31G000717	SOPLETE KT-717 Manual	6	32,62 €



Válida para
masillas

PISTOLA SILICONA

Pistola profesional.
Gran multiplicación que favorece la extrusión del producto con el mínimo esfuerzo. Ligera y resistente.



ENVASE	PRECIO
12	6,53 €

Pistola cartucho

PISTOLA POLIURETANO



ENVASE	PRECIO
1	38,87 €

Nº 193



Brocas Helicoidales Mango Cilíndrico Serie Corta
 Jobber Series Straight Shank Twist Drills
 Forets Hélicoïdaux Queue Cylindrique Série Courte

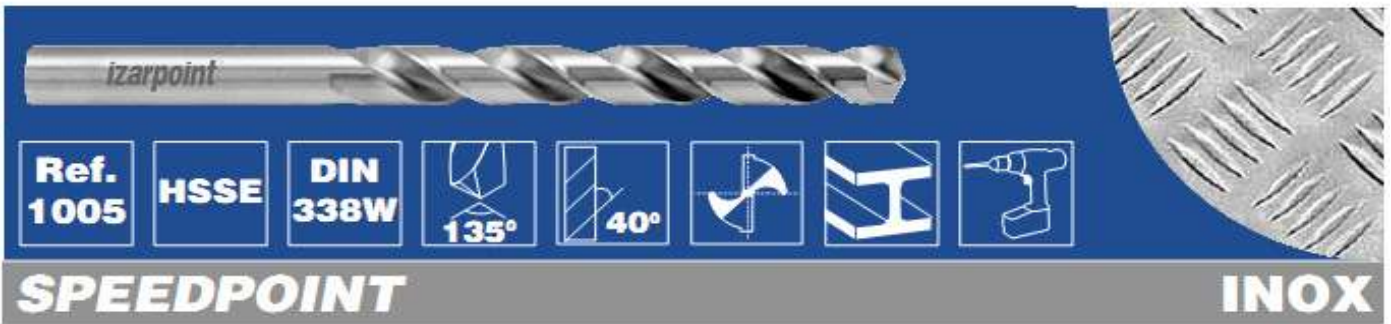

INOX Stainless	Al	Blanca Bright Finish	Rendim. ↑↑↑ Perform.	Chapa < 5 mm	● Recomendado - Recommended
					○ Alternativa - Alternative
					○ Posible - Possible

Ventajas
Advantages

1

Geometría Hélice especialmente diseñada para trabajar INOX.
 40° Hélice: Mejor Evacuación de Viruta
 Helix Geometry specially designed for Series 300 austenitic Stainless Steels.
 Helix 40°: Better Chipping Off

2

Afilado/Aguzado Autocentrante: Facilita la Penetración con mínimo Esfuerzo
 Self-Centering Split Point: Makes Drilling easier with minimal Effort

Ø mm	L mm	l mm		Nº Art.	PRECIO/UD
2,00	49	24	2	24757	5,88 €
2,50	57	30	2	24758	5,35 €
3,00	61	33	2	24759	5,22 €
3,25	65	36	2	24760	6,20 €
3,50	70	39	2	24761	6,07 €
4,00	75	43	2	24762	6,55 €
4,25	75	43	1	24763	3,66 €
4,50	80	47	1	24764	3,66 €
5,00	96	52	1	24765	3,92 €
5,50	93	57	1	24766	4,96 €
6,00	93	57	1	24767	5,30 €
6,50	101	63	1	24768	5,98 €
7,00	109	69	1	24769	6,51 €
7,50	109	69	1	24770	6,92 €
8,00	117	75	1	24771	8,10 €
8,50	117	75	1	24772	8,47 €
9,00	125	81	1	24773	10,81 €
10,00	133	87	1	24774	11,99 €
11,00	142	94	1	24775	17,81 €
12,00	151	101	1	24776	22,00 €
13,00	151	101	1	24777	24,86 €

Brocas Punta Metal Duro PARED PROFESIONAL
 PROFESSIONAL CONCRETE Carbide Tipped Twist Drills
 Forets Pointe Carbure BETON PROFESSIONNEL



Hormigón Bloque / C. Block

Ø mm	L mm	I mm		Nº Art.	PRECIO/UD
3	60	35	1	30232	2,49 €
4	75	45	1	18525	2,49 €
5	85	40	1	18526	2,53 €
5,5	85	40	1	23983	2,63 €
6	100	55	1	18528	2,72 €
6,5	100	55	1	23984	2,97 €
7	100	55	1	18529	3,28 €
8	120	70	1	18531	3,65 €
9	10	70	1	18532	4,59 €
10	120	70	1	18534	4,59 €
11	150	90	1	17858	5,88 €
12	150	90	1	18535	6,87 €
13	150	90	1	30234	8,60 €
14	150	90	1	18537	10,13 €
16	150	90	1	30235	18,45 €

Ø mm	L mm	I mm		Nº Art.	PRECIO/UD
5	150	80	1	30176	3,51 €
6	150	80	1	30200	4,29 €
8	200	130	1	30208	6,65 €
10	200	130	1	30214	8,19 €
12	200	130	1	30222	8,35 €



Hormigón Bloque / C. Block

Ø mm	L mm	I mm		Nº Art.	PRECIO/UD
6	400	300	1	30202	7,74 €
8	400	300	1	30212	7,74 €
10	400	300	1	30216	8,10 €
12	400	300	1	30227	8,70 €
14	400	300	1	30233	11,09 €
16	400	300	1	30237	19,38 €
18	400	300	1	30207	24,23 €
20	400	300	1	30225	26,85 €
22	400	300	1	16474	30,90 €
24	400	300	1	16475	31,99 €
25	400	300	1	16476	36,54 €

Ø mm	L mm	I mm		Nº Art.	PRECIO/UD
10	600	450	1	30218	13,27 €
12	600	450	1	30229	14,47 €
14	600	450	1	30236	17,52 €
16	600	450	1	30238	22,34 €
18	600	450	1	16477	30,06 €
20	600	450	1	16478	34,88 €



EXTREME

Ref.
1882



Porcelánico / Porcelain



-Punta MD 1ª calidad
 -Excelente soldadura
 -Revolucionaria geometría

-1ª quality carbide tip
 -Excellent welding
 -Revolutionary geometry

- Pointe Carbone 1^{re}
 Qualité
 - Excellente Soudure
 - Géométrie révolutionnaire

Materiales:

Porcelánico, teja, piedra, granito, pizarra, Cemento, terrazo, mármol, terracota

Materials:

Porcelain, tile, quarry, granite, slate, Cement, marble, terracotta

Matériaux:

Porcelaine, tuile, pierre, granit, ardoise, Ciment, granit, marbre, terre cuite

-Utilizar sin percusión
 -Refrigeración constante con agua
 -Usar a bajas revoluciones

-Use no percussion
 -Constant water-cooling
 -Use at low speed

- Utiliser sans percussion
 - Refroidissement constant avec de l'eau
 - Faible vitesse

Ø mm	L mm	l mm		Nº Art.	PRECIO/UD
3	85	42	1	13903	18,52 €
3,5	85	42	1	13906	18,52 €
4	85	50	1	13909	18,52 €
4,5	85	50	1	13910	18,52 €
5	85	50	1	14030	19,58 €
6	100	65	1	14036	19,58 €
7	125	75	1	14061	23,43 €
8	125	75	1	14062	25,38 €
9	150	90	1	14063	30,78 €
10	150	90	1	14066	30,78 €
11	150	90	1	14068	39,96 €



Ref.
1482

Cont. Ø	Nº Art.	PRECIO/UD
4 Pcs: 4-5-6-8	31004	86,45 €

Brocas-Martillo SDS plus HORMIGON
 CONCRETE SDS plus Rotary Hammer Drill Bits
 Forets Percussion SDS plus BETON



Ref. 1890 **SDS plus** **Canal KVS Flute**

Hormigón/ Concrete/ Béton Hormigón Bloque / C. Block

1. Nuevo Diseño Punta => Mejor Centrado + Taladrado rápido y preciso
 1. New Point Design => Better Centering + fast & exact Drilling

2. Esta Punta penetra más rápidamente y dirige el Polvo hacia el Doble Canal
 2. This Point drills faster and carries the Dust through the Double Channel

3. El Canal KVS extrae el Polvo más rápido y ahorra tiempo y dinero
 3. This KVS Flute pulls out the Dust faster and saves time & money

4. La Geometría del Canal KVS reduce Vibraciones y estrés de Operario y Máquina => Taladrado más fácil.
 4. The KVS Flute Geometry reduces Vibration and Stress for Man & Machine => Easier Drilling

- Seguro 2 ranuras.
- Utilizar con taladro-percutor.
- Resistente al calentamiento.
- Apto para trabajo intensivo

• Canal KVS ø 4x110 - 16x1000 mm
 • Canal standard ø 18x200 - 26x450 mm

- 2 slot safety device.
- Use with hammer-drill
- Heat-resistant.
- Intensive work.

• KVS flute ø 4x110 - 16x1000 mm
 • Standard flute ø 18x200 - 26x450 mm

Ø mm	L mm	I mm	PRECIO/UD	Nº Art.	€
4	110	50	1	30245	5,65
5	110	50	1	30246	4,10
5	160	100	1	30247	5,34
5,5	110	50	1	23976	4,76
5,5	160	100	1	23977	5,99
6	110	50	1	30248	4,21
6	160	100	1	18538	4,85
6	210	150	1	30249	8,02
6	260	200	1	30251	10,32
6,5	110	50	1	23978	4,82
6,5	160	100	1	23979	5,66
7	110	50	1	30252	6,08
7	160	100	1	30253	6,53
8	110	50	1	30254	5,32
8	160	100	1	18540	5,08
8	210	150	1	30255	7,26
8	260	200	1	30256	10,29
8	460	400	1	30257	21,58
9	160	100	1	11518	8,10
9	210	150	1	11519	8,83
10	110	50	1	30261	6,07
10	160	100	1	30262	6,81
10	210	150	1	18541	8,18
10	260	200	1	30263	12,04
10	310	250	1	30264	13,95
10	450	400	1	30266	22,58
10	600	550	1	30267	31,63
11	160	100	1	11520	8,94
11	210	150	1	25600	9,04
11	260	200	1	11521	15,37
12	160	100	1	30270	7,24
12	210	150	1	30271	9,17
12	260	200	1	30273	13,01
12	450	400	1	30414	20,66
12	600	550	1	30275	32,73
12	1000	950	1	30269	78,22
13	160	100	1	30276	8,64
13	310	250	1	30278	16,96
14	160	100	1	30280	9,95
14	210	150	1	30281	14,51
14	310	250	1	30283	18,38
14	450	400	1	30284	24,16
14	600	550	1	30285	35,85

Ø mm	L mm	I mm	PRECIO/UD	Nº Art.	€
14	1000	950	1	30279	85,04
15	160	100	1	30286	13,81
16	160	100	1	30291	13,81
16	210	150	1	30292	16,84
16	310	250	1	30294	19,42
16	450	400	1	30295	28,72
16	600	550	1	30296	38,57
16	800	750	1	30298	63,18
16	1000	950	1	30299	96,56
18	200	150	1	30300	21,63
18	300	250	1	30413	28,75
18	450	400	1	30303	32,79
18	1000	950	1	30299	99,28
20	200	150	1	30306	30,07
20	300	250	1	30309	33,75
20	450	400	1	30311	42,56
20	600	550	1	30312	63,18
20	1000	950	1	30305	100,70
22	250	200	1	30314	38,64
22	450	400	1	30317	53,78
22	600	550	1	23980	64,40
22	1000	950	1	23986	101,65
24	250	200	1	30319	45,08
24	450	400	1	30322	58,49
25	250	200	1	30324	48,79
25	450	400	1	30327	62,54
25	1000	950	1	23987	112,26
26	250	200	1	11522	61,14
26	450	400	1	30330	69,03



Ø mm	L mm	I mm	PRECIO/UD	Nº Art.	10 Pcs €
5	110	50	10	18706	36,95
5	160	100	10	18707	48,04
6	110	50	10	18710	37,92
6	160	100	10	18712	43,69
6	210	150	10	18714	72,22
8	110	50	10	18715	47,90
8	160	100	10	18716	45,75
8	210	150	10	18717	65,37
10	110	50	10	18719	54,66
10	160	100	10	18721	61,26
10	210	150	10	18722	73,67
12	160	100	10	18723	65,13
12	210	150	10	18724	82,45

Punteros y Cinceles SDS plus / SDS max

SDS plus / SDS max Chisels

Burins SDS plus / SDS max



Ref. 1870

SDS plus

Hormigón Reforzado

Hormigón/ Concrete/ Béton

Codigo	Tipo	L mm	Ancho mm	Nº Art.	PRECIO/UD
00001	Puntero	250		30372	10,11 €
00002	Plano	250	20	30373	10,11 €
00003	Ancho	200	36	30374	17,31 €
00004	Acanalador	200	22	30375	20,88 €



Ref. 1872

SDS max

Hormigón Reforzado

Hormigón/ Concrete/ Béton

Codigo	Tipo	L mm	Ancho mm	Nº Art.	PRECIO/UD
00001	Puntero	400		30376	17,12 €
00006	Puntero	600		23036	23,09 €
00002	Plano	400	24	30377	17,12 €
00007	Plano	600	24	23037	23,09 €
00008	Ancho	360	50	23038	25,47 €
00003	Ancho	300	80	30378	38,26 €
00004	Acanalador	300	32	30379	42,47 €
00005	Con Alas	380	35	18186	94,13 €

Ref.
1645

 HSSE
 8% Co

 INOX
 Stain-
 less

Bimetal

 TPI
 4-6

Acero <850 N/mm² Steel

INOX / Stainless Steel

Fundición / Cast Iron / Fonte

Cobre / Copper / Cuivre

Aluminio / Aluminium

Madera / Wood / Bois



Ø mm	P.G.	Ø Inches		Nº Art.	PRECIO/UD
14		9/16"	1	20094	13,67 €
16	9	5/8"	1	20104	13,67 €
17		11/16"	1	21321	13,67 €
19	11	3/4"	1	30250	13,67 €
20		25/32"	1	30258	13,67 €
21	13,5	13/16"	1	30260	13,67 €
22	16	7/8"	1	30265	13,67 €
23		14/16"	1	30268	13,67 €
24		15/16"	1	30274	13,67 €
25		1"	1	30282	14,34 €
27		1 1/16"	1	30287	15,17 €
29	21	1 1/8"	1	30289	15,17 €
30		1 3/16"	1	30293	15,17 €
32		1 1/4"	1	30297	15,17 €
33		1 5/16"	1	30301	15,17 €
35		1 3/8"	1	30302	15,17 €
37	29	1 7/16"	1	30304	16,15 €
38		1 1/2"	1	30307	16,15 €
40		1 9/16"	1	30308	16,15 €
41		1 5/8"	1	30310	16,19 €
43		1 11/16"	1	30313	16,19 €
44		1 3/4"	1	30315	19,91 €
46		1 13/18"	1	30316	19,91 €
48	36	1 7/8"	1	30318	19,91 €
50			1	18800	19,91 €
51		2"	1	30320	19,91 €
52		2 1/16"	1	30321	23,42 €
54	42	2 1/8"	1	30323	23,42 €
57		2 1/4"	1	30325	23,46 €
59	48	2 5/16"	1	30326	23,46 €
60		2 3/8"	1	30328	23,46 €
63			1	18801	25,58 €
64		2 1/2"	1	30329	25,58 €
65		2 3/16"	1	30331	25,58 €
67		2 5/8"	1	30388	25,58 €
68		2 11/16"	1	30391	25,58 €
70		2 3/4"	1	30392	25,58 €
73		2 7/8"	1	30393	25,58 €
76		3"	1	30394	26,20 €
79		3 1/8"	1	30395	26,22 €
83		3 1/4"	1	30396	26,22 €
86		3 3/8"	1	30397	26,22 €
89		3 1/2"	1	30397	26,22 €
92		3 5/8"	1	30399	30,41 €
95		3 3/4"	1	30400	35,67 €
98		3 7/8"	1	30401	38,20 €
102		4"	1	30402	39,91 €
114		4 1/2"	1	30403	74,60 €
121		4 3/4"	1	30404	83,13 €
127		5"	1	30405	88,29 €
140		5 1/2"	1	30406	94,40 €
152		6"	1	30407	97,88 €
160		6 5/16"	1	24475	192,50 €
210		8 9/32"	1	24606	227,74 €

Ref.
1646

 Husillos de Expulsión Rápida
 Quick Expulsion Spindles
 Arbres d'expulsion Rapide

 HSSE
 5% Co

 INOX
 Stain-
 less

MOD.	Ø CORONA			Nº Art.	PRECIO/UD
H3A	14-30	9,52	1	19602	14,56 €
H4A	32-210	9,52	1	19603	25,09 €
H3C	14-30	9,52	1	39848	14,56 €
H4C	32-210	9,52	1	39849	25,09 €



MOD.	Características		Nº Art.	PRECIO/UD
BR 85	Broca L 85 Drill	1	19605	4,05 €
BR 105	Broca L 105 Drill	1	30019	4,44 €
BRC 110	Broca L 110 Drill	1	39850	4,44 €

Coronas Ligeras PARED PROFESIONAL
 PROFESSIONAL CONCRETE Light Hollow Core Bits
 Trépans BETON PROFESSIONNEL



Ref. 1695

Diente MD



SDS plus

Carbide Tipped

Rosca Interna M-16
 M-16 Internal Thread
 Filetage Interieur M-16

Hormigón Bloque / C. Block

Ladrillo / Brick / Brique



Ø mm	L mm	Nº Art.	PRECIO/UD
30	58	13898	56,50 €
35	58	13899	66,90 €
40	58	13900	76,71 €
45	58	13901	80,74 €
50	58	13902	84,20 €
65	50	13904	88,06 €
68	50	19012	92,51 €
80	50	19014	92,51 €
82	50	19032	115,22 €
90	50	25207	117,93 €
100	50	25208	136,17 €



Brocas Centrar
 Center Drill Bits
 Forets à Centrer

Husillos SDS plus
 SDS plus Spindles
 Arbres SDS plus

Ref. 1696



Husillos Hexagonales
 Hexagon Spindles
 Arbres Héxagonales

Codigo	Ø mm	L mm	Nº Art.	PRECIO/UD
00001	8	100	18857	10,96 €

Codigo	L mm	Nº Art.	PRECIO/UD
00003	110	18858	31,14 €
00004	220	19021	41,42 €
00005	350	19023	58,88 €

Codigo	L mm	Nº Art.	PRECIO/UD
00006	110	19018	27,42 €
00004	220	19026	35,97 €
00005	350	19030	48,15 €

NORTON

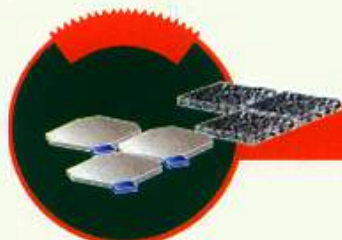

DUO LASER

**LASER WELDED
DIAMOND BLADES**



MAYOR RENDIMIENTO

El segmento doble de 12 mm. de altura aumenta de forma espectacular la vida del disco.

UN CORTE MAS RAPIDO

La innovadora tecnología del doble segmento trapezoidal, así como la exclusiva geometría de las entallas, permiten una mejor evacuación del material cortado y una mejor refrigeración del disco. Todo en la concepción del DUO LASER contribuye a una elevadísima velocidad de corte.

UN CORTE SEGURO Y PRECISO

La nueva forma de los segmentos asegura la calidad de corte y el confort de un disco de banda continua pero con la seguridad de los segmentos soldados con láser, incluso en uso intensivo.

MONTAJE CORRECTO DEL DISCO A LA PRIMERA

La geometría de las entallas indica el sentido de rotación del disco y permiten al utilizador colocar el disco en el sentido correcto solo al verlo.

FABRICACION 100% EUROPEA

Este nuevo disco de diamante ha sido fabricado en nuestro centro de producción situado en el Gran Ducado de Luxemburgo, lo que ofrece una garantía de calidad y seguridad óptima.

UN CONCEPTO INNOVADOR Y EXCLUSIVO

El DUO LASER ha sido diseñado por los ingenieros de NORTON, con nuevos aglomerantes metálicos y mejores calidades de diamante, para un uso intensivo con máquinas portátiles. La geometría única del DUO LASER está protegida por un certificado de utilización nº F40-70.

EXTENSO CAMPO DE APLICACIONES

Los componentes utilizados en la fabricación del disco DUO LASER, le aseguran unos rendimientos iguales en el corte de productos de hormigón, al igual que en materiales muy duros (granito, klinker, etc...).

NORTON... EXPERTOS EN EL CORTE DE MATERIALES

DIAMETRO	PRECIO
230	158,33 €



JUEGO LLAVES DE VASO 1/4 43 PIEZAS ACERO CR-VANADIO
SOCKETS SETS 1/4 43 PIECES CR-VANADIUM STEEL



CONTENIDO / CONTENTS

Vasos – Sockets: 4, 4'5, 5, 5'5, 6, 7, 8, 9, 10, 11, 12, 13.

⊕ 1, 2, 3. - ⊖ 4, 5'5, 7. - ⊗ 1, 2, 3.

★ T-10, 15, 20, 25, 30, 40 - ○ 3, 4, 5, 6, 8

1 CARRACA – RATCHET.

2 ALARGADERAS – EXTENSIÓN BAR.

1 ARTICULACIÓN – UNIVERSAL JOINT.

1 DESTORNILLADOR FLEXIBLE – FLEXIBLE SCREWDRIVER.

3 LLAVES ALLEN – HEX KEYS.

PRECIO

112,58 €



JUEGO LLAVES DE VASO 1/2 20 PIEZAS ACERO CR-VANADIO
SOCKETS SETS 1/2 20 PIECES CR-VANADIUM STEEL



CONTENIDO / CONTENTS

Vasos – Sockets: 10, 11, 12, 13, 14, 15, 16, 17, 19, 22, 24, 27, 30, 32.

1 CARRACA – RATCHET.

2 ALARGADERAS – EXTENSIÓN BAR.

1 ARTICULACIÓN FLEXIBLE – FLEXIBLE JOINT.

1 LLAVE DE BUJÍAS – SOCKET F. SPARK PLUGS.

1 ADAPTADOR 1/2 a 3/8 – ADAPTER 1/2 to 3/8.

PRECIO

147,75 €

LA TENAZA AUTOAJUSTABLE "HYPO"

- **MAYOR PAR**
- COMPARADO CON EL ALICATE UNIVERSAL



- **PERFECTA ADAPTABILIDAD**
- PARA TRABAJAR PIEZAS DE CUALQUIER FORMA HASTA \varnothing 40 MM

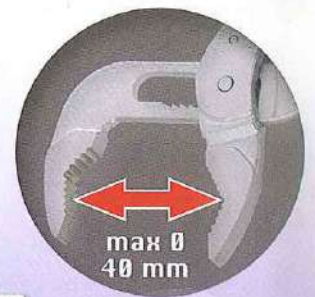

- **MECANISMO DE CIERRE**
- EL AGARRE DE LA PIEZA A TRABAJAR SE HACE FÁCILMENTE

- **MATERIAL:** ACERO DE COMPOSICIÓN ESPECIAL ADECUADA PARA TEMPLE Y REVENIDO

UNIOR 240
No 442 HYPO

HYPO 442

- **BOTÓN DE CIERRE**



- **SUPERFICIES DE TRABAJO ENDURECIDAS POR INDUCCIÓN**

- **ACABADO SUPERFICIAL: CROMADO**

- **CABEZA PULIDA**

- **FORMA ERGONOMICA**
- MANGO DE DOBLE COMPONENTE DE ALTA RESISTENCIA
- MÁXIMA ADAPTABILIDAD A LA MANO



- **AGARRE RÁPIDO Y SENCILLO**
- SE UTILIZA CON SÓLO UNA MANO

- **SEGURIDAD**
- LA PROTECCIÓN ANTIDESLIZAMIENTO PROTEGE LA MANO
- **MAYOR DURACION**

MARCADO "UNIOR"



PRECIO

35,78 €

Unior Espana S.L.
Pol. Leizotz, s/n, Parc. F-Pab.E
20140 ANDOAIN (GUIPUZCOA)
☎ +34 943 30 41 82
☎ +34 943 59 34 09
✉ uniores@telefonica.net
🌐 www.unior.com

442

LA TENAZA AUTOAJUSTABLE
"HYPO"

Code

611780

L

240

max Ø

40



370



10

TENAZAS

TENAZA PICO DE LORO

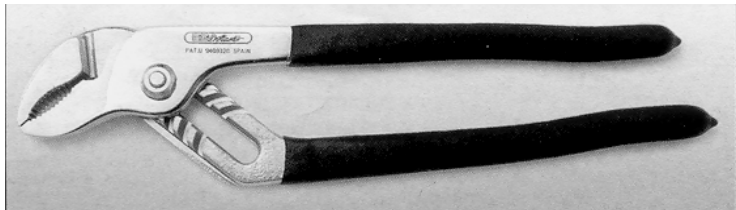

		PRECIO
CODIGO	MEDIDA	Euros
0895011275	10"	21,62

TENAZA PICO DE LORO Cobra Knipex



		PRECIO
CODIGO	MEDIDA	Euros
8702250	10"	54,17
87002300	12"	76,75

ALICATE TIPO FORD

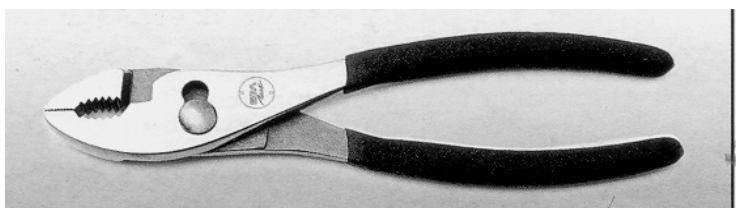

		PRECIO
CODIGO	MEDIDA	Euros
0895011247	8"	17,58

TENAZA RUSA



		PRECIO
CODIGO	MEDIDA	Euros
0895011447	10"	10,00

TENAZA GRIP



		PRECIO
CODIGO	MEDIDA	Euros
0895011576	5"	11,82
0895011583	7"	14,12

TENAZA LLAVES Cobra Knipex



		PRECIO
CODIGO	MEDIDA	Euros
8605250	0 - 46	66,50

TERRAJA

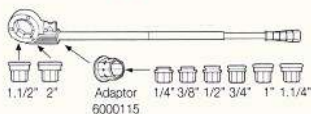

Cabezales de 1/2" a 1 1/4"

CODIGO	Precio
0437004171	157,88 €

BOMBA COMPROBACION RP50



Depósito galvanizado resistente a la intemperie y bajas temperaturas. El sistema de válvulas dobles y el vástago de la válvula con cabeza esférica resistentes a la oxidación, aseguran la presión constante. Embolo de poliamida sin distorsión, resistente al desgaste. Manómetro de fácil lectura y escala precisa

Datos técnicos:

Capacidad 12l
Gama de presión de 0-60 bar, de 1 en 1 bar.
Tres escalas: (bar, psi y Mpa).
Dimensiones 720x170x260 mm
Conexiones R 1/2"

Bomba RP50	R6.1004	329,83 €
Manómetro conexión R1/2	R6.1315	34,75 €
Embolo	R6.1300	28,75 €
Juego juntas estancas	R6.1301	20,17 €
Manguera conexión 1/2	R6.1306	65,00 €

PEINES



	1/4"	42,50 €
	3/8"	42,50 €
	1/2"	42,50 €
	3/4"	42,50 €
0895014252	1"	42,50 €
0895014269	1 1/4"	42,50 €
	1 1/2"	53,00 €
	2"	53,00 €

Fabricados en acero de alta calidad para una duración prolongada. La geometría del peine garantiza un corte de virtas excelente y un primer corte inicial.

SIERRA DE ARCO



CODIGO	Precio
0895062221	23,78 €

TENAZA CURVATUBOS

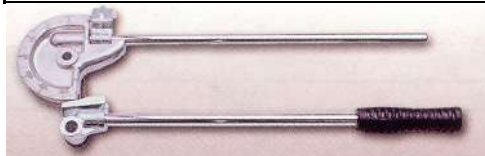

CODIGO	Ø	Precio
	10	60,42 €
0895022197	12	64,42 €
0895022207	14	76,67 €
0895022214	15	80,45 €
0895022228	16	91,40 €

DESATASCADOR MANUAL



5 metros de espiral metálica y flexible

CODIGO	Precio
0746003612	41,08 €

DESTORNILLADOR BUSCAPOLOS



CODIGO	Precio
0895019875	3,40 €

TENAZA DE SIFON 530



De mayor capacidad que cualquier otro alicate o tenaza. 4 posiciones de trabajo. Adecuada para manipular accesorios roscados de PVC hasta 62mmØ

CODIGO	Precio
0895011397	35,42 €

TUERCA PERFORADORA



Tuercas perforadoras diseñadas para una perforación uniforme, sin deformaciones en planchas de acero inoxidable, hierro, aluminio, cobre, latón, goma, cuero y plástico. Ideal para trabajar en espacios reducidos (p.e. cajas de distribución, fregaderos, etc). Cada tuerca perforadora está compuesta por matriz y tornillo de presión.

CODIGO	Precio
0437012220	76,63 €



STANDARD

CORTATUBOS



TELESCOPICO

CODIGO	MEDIDA	UD.	Precio
0895014797	Ø 32 mm	12	26,17 €
0895014559	Cuchilla Cobre	10	8,70 €
	Cuchilla Inox	10	10,50 €

CODIGO	MEDIDA	UD.	Precio
0437005451	Ø 32 mm	6	42,00 €
0895014559	Cuchilla Cobre	5	8,70 €
	Cuchilla Inox	5	10,50 €



TIJERA MANUAL para tubos plásticos

CODIGO	MEDIDA	Precio
0895050505	Ø 42 mm	72,52 €



MINI

CODIGO	UD.	Precio
0895014529	6	9,00 €

LLAVE DE LAVABO



CODIGO	Precio
0895006037	56,33 €

JUEGO LLAVES ALLEN

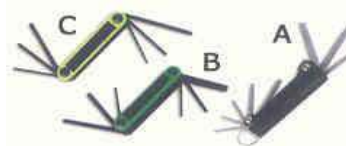

Tipo Navaja

CODIGO	Precio
	27,60 €

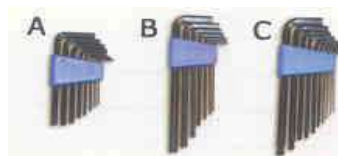

Con Bola (Nº 1,5 al 10)

CODIGO	Precio
	19,97 €

9 piezas

LLAVE STILLSON 101



Mango monoblock con sección en doble T. Lengua y postizo con doble tratamiento y recambiables. Tuerca de

ajuste de fácil agarre. Su diseño permite una mayor capacidad de apertura de bocas para el mismo tamaño de mango. Normas americanas GGG-W-651e Tipo II, Clase A. Fabricadas de acuerdo con las normas UNE 16.554.

CODIGO	MEDIDAS		PRECIO
	L	Ø	
	8"	3/4"	23,08 €
0895005961	10"	1"	29,75 €
	12"	1 1/4"	32,42 €
0895005988	14"	1 1/2"	41,50 €
	14"	1 1/2"	43,75 € (1)
0895005997	18"	2"	57,08 €
0437000203	24"	2 1/2"	100,50 €
0437000234	36"	3 1/2"	194,17 €

(1) - Con mango de goma

LLAVE HEAVY DUTY 102



Mango monoblock con sección en doble T. Lengua y postizo con doble tratamiento y recambiables. Tuerca de

ajuste de fácil agarre. Su diseño permite una mayor capacidad de apertura de bocas para el mismo tamaño de mango. Normas americanas GGG-W-651e Tipo II, Clase A. Fabricadas de acuerdo con las normas UNE 16.554.

CODIGO	MEDIDAS		PRECIO
	L	Ø	
	8"	1"	26,75 €
	10"	1 1/2"	32,67 €
	12"	2"	43,33 €
0895006111	14"	2"	47,75 €
	18"	2 1/2"	68,08 €
	24"	3"	111,17 €
0895006147	36"	5"	218,83 €
	48"	6"	387,58 €

LLAVE ALUMINIO 104



Mango monoblock con sección en doble T fabricado en aleación de aluminio, ultra ligero (40% menos de peso). Lengua y

postizo con doble tratamiento. Tuerca de ajuste de fácil agarre. Su diseño permite una mayor capacidad de apertura de bocas para el mismo tamaño de mango. Normas americanas GGG-W-651e Tipo II, Clase C. Fabricadas de acuerdo con las normas UNE 16.554.

CODIGO	MEDIDAS		PRECIO
	L	Ø	
	10"	1 1/2"	39,25 €
0895006183	14"	2"	52,25 €
0895006197	18"	2 1/2"	74,67 €
	24"	3"	124,58 €
0895006214	36"	5"	219,00 €
	48"	6"	387,58 €

LLAVE SUECA tipo S 145



Totalmente forjada, sin puntos de soldadura. Mordazas rectificadas, con doble tratamiento térmico y con

diseño apropiado para acceder a lugares difíciles. Agarre perfecto del tubo con tres puntos de contacto. Mango y tuerca reforzados. Fabricado de acuerdo con la norma DIN 5234.

CODIGO	Ø	PRECIO
	1/2"	39,25 €
0895006054	1"	52,25 €
0895006068	1 1/2"	74,67 €
	1 1/2"	124,58 € (1)

(1) - Con mango de goma

LLAVE PARA TUBO



PRECIO
42,47 €
49,78 €

MASTERGRIP				
COD	← L →	Ø	Kg	
61405	10"	1/4-1.1/2"	0,9	
61406	14"	1/2-2"	1,65	1



CINCEL de ranurar



Acero al cromo manganeso silicio. Sección plana ovalada

CODIGO	MEDIDA	Precio
0895014915	72 x 240	14,08 €

MACETA de albañil



Maceta española. Forjada. Para trabajo intensivo. Mango de madera de fresno.

CODIGO	PESO	Precio
	1300 gr.	16,58 €



LLAVE AJUSTABLE CON MANGO DE GOMA
 ACERO CROMO VANADIO - BOCAS DENTADAS
 CON ESCALA MILIMETRICA - MANGO ANATOMICO

MEDIDA		ENVASE	PRECIO
6"	150 mm	8	21,50 €
8"	200 mm	8	22,78 €
10"	250 mm	8	32,18 €
12"	300 mm	4	33,85 €



NIVEL TORPEDO - MAGNETICO - 3 FIOLAS

MEDIDA	ENVASE	PRECIO
200 mm	25	4,17 €



NIVEL MAGNETICO DE ALUMINIO
 ANTICHOQUE - 3 AÑOS DE GARANTIA

MEDIDA	ENVASE	PRECIO
200 mm	1	12,27 €
500 mm	1	16,03 €
600 mm	1	19,33 €
800 mm	1	22,53 €



DESTORNILLADOR PLANO PARALELO ELECTRICISTA – BI-MATERIAL – ACERO CROMO VANADIO PLUS – MAGNÉTICO.



MEDIDA	€ EUROS	
3,2X75	2,77	12
3,2X150	3,90	12
4X125	3,53	12
4X150	4,03	12
5X150	4,75	12

DESTORNILLADOR POZIDRIV – BI-MATERIAL – ACERO CROMO VANADIO PLUS – MAGNÉTICO.



MEDIDA	€ EUROS	
PZ-0X75	3,25	12
PZ-1X100	4,53	12
PZ-2X100	5,32	12
PZ-3X150	7,30	12
PZ-4X200	9,40	12

DESTORNILLADOR PLANO MECÁNICO – BI-MATERIAL – ACERO CROMO VANADIO PLUS – MAGNÉTICO.



MEDIDA	€ EUROS	
3,2X75	3,25	12
4X100	3,38	12
4X125	3,53	12
5X125	4,67	12
5X150	4,75	12
6X175	5,82	12
8X200	7,80	6
9,5X250	9,35	6

DESTORNILLADOR PHILIPS – BI-MATERIAL – ACERO CROMO VANADIO PLUS – MAGNÉTICO.



MEDIDA	€ EUROS	
PZ-0X75	3,25	12
PZ-1X100	4,35	12
PZ-2X100	5,32	12
PZ-3X150	7,30	12
PZ-4X200	9,90	12

DESTORNILLADOR TORX – BI-MATERIAL – ACERO CROMO VANADIO PLUS – MAGNÉTICO.



MEDIDA	€ EUROS	
T-6	3,68	12
T-7	3,68	12
T-8	3,68	12
T-9	3,68	12
T-10	4,75	12
T-15	4,75	12
T-20	4,75	12
T-25	5,53	12
T-27	5,53	12
T-30	6,53	12
T-40	7,22	12

DESTORNILLADOR CARROCEROS – BI-MATERIAL – ACERO CROMO VANADIO PLUS – MAGNÉTICO.



€ EUROS	
3,75	12

JUEGO DESTORNILLADORES 5 PIEZAS – ACERO CROMO VANADIO PLUS – PUNTA MAGNÉTICA – BI-MATERIAL.

CONTENIDO

PHILIPS N 1 x 100
PHILIPS N 2 x 100

PLANO / PARALLEL
PLANO / PARALLEL
PLANO / SLOTTED

2'5 x 75
4 x 125
5 x 150



€ EUROS	
23,38	5-25

ESCALISIMA

Escalera telescópica en aluminio nervado con base alargada. Escalera para uso profesional y de bricolaje.

> Dotación standard <

- Peldaño antideslizante de 27 mm.
- Distancia entre peld. 28 mm.
- Tacos en PVC.
- Embalaje en plástico termoretráctil.
- Perfil larguero interno 57x27 mm.
- Perfil larguero exterior 48.5 mm.
- Ancho de base 64 cm.
- Bandeja portaherramientas de nylon de 31x26 cm.

La nueva articulación automática en aluminio de tres posiciones permite:

- 1- abrir y cerrar la escalera en posición de "tijera".
- 2- bloquear la escalera abierta en posición "tijera".
- 3- abrir la escalera en posición de apoyo a "pared" y bloquearla.

Nº Peld.	Alto m	Altura tijera m	Altura pared m	Ancho base cm	Capacidad Kg	Peso Kg	PRECIO €
6+6	0,94	1,43	2,93	64	150	8,5	221,67
7+7	1,22	1,68	3,48	64	150	9,6	246,67
8+8	1,22	1,94	4,03	64	150	11,0	265,00
9+9	1,53	2,23	4,64	64	150	12,0	291,67
10+10	1,53	2,51	5,22	64	140	13,0	315,00
11+11	1,81	2,82	5,80	64	130	14,0	331,67
12+12	1,81	3,10	6,35	64	120	15,0	358,33

Articulación automática en fusión de aluminio



Gancho de acero recubierto de nylon reforzado



Bandeja porta-herramientas en nylon 31x26 cm.



A Pared



Desnivel sobre escalera

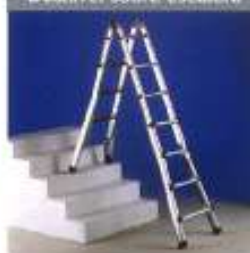

Cerrada



Norma
EN131
Europea B+C
7+7, B+C, 9+9
y 10+10

Hasta
150
Kg

Garantía
5
Años

ISO 9000
EN ISO 9000/1

PROMOCION

ESCALISIMA de 8 x 8 peldaños

Comprando 1 unidad descuento

5%

Comprando 2 unidades descuento

10%

PRODUCTOS PARA LEÑA Y PELLETS

JUNTA DE FIBRA DE VIDRIO. LARGO 2.5 m. + TUBO DE COLA REFRACTARIA
Utilización. Junta de estanquidad para puertas de casetes, estufas, calderas, etc.

productos	referencia	descripción
-----------	------------	-------------



JU9008

• REDONDA Ø 8 mm.

PRECIO

12,48 €



M7031

• Deshollnador para estufas de pelet.
• 1,5 Kg

NOVEDAD

PRECIO

12,97 €

Aspirador de cenizas
ESPECIAL ESTUFA DE PELLET ▶ POTENCIA 1000 W
CAPACIDAD 10 L

- LARGO CABLE: 3 m.
- CAPACIDAD: 10 L
- POTENCIA: 1000 W
- MEDIDAS: 270 X 270 X 330 mm.

Usos:

- Barbacoa
- Comerica
- Estufa

ESPECIAL ESTUFA DE PELLET

Accesorios:

- Manguera 1m
- Boquilla estrecha
- Filtro HEPA
- Bolsa protectora para filtro HEPA
Impide que el filtro HEPA se obstruya, consiguiendo así una mejor aspiración.

PRECIO

NETO

35,00 €

Flexos Ducha

COAFLEX Flexo plastico multicapa 1,5 m.



COLOR	REFERENCIA	ENV,	PRECIO
Blanco	64801	blister	6,33 €

SILVERFLEX Flexo 1,75 m.



COLOR	REFERENCIA	ENV,	PRECIO
Plateado	65713	caja	15,81 €

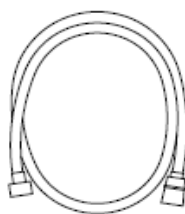

Flexo ducha inox extensible 1,75 – 2,30 m.



CODIGO	UN.	PRECIO
60002	12	4,79 €
	25	4,60 €
	50	4,42 €

KIT DUCHA N° 1

Mango Ducha 4 posiciones
Soporte Regulable
Flexo Inox Reforzado de 1,75 a 2,20 metros

CODIGO	UN	PRECIO
H571SETB	6	19,58 €
	20	Dto. 5%



Kit ducha ISABELA

Mango Ducha 5 funciones, anticalcareo
Barra Mural Ø 25, longitud 66 cm
Permite utilizar agujeros de taladro ya existentes en la pared.
Soporte Cónico
Flexo Inox Reforzado de 1,75 a 2,10 metros

CODIGO	UN	PRECIO
HC412L25F2	3	26,97 €
	6	Dto. 5%

Mangos de Ducha

EON

Ref.: 61113
Cromo / Chrome
Caja / Box

5 jets antical / antilime



UN	PRECIO
4	16,61 €



EVO

Ref.: 60313
Cromo / Chrome
Caja / Box

5 jets antical / antilime



UN	PRECIO
4	18,70 €



Mango de ducha LED

CROMOTERAPIA, cambia de color según la temperatura. Sin baterías

CON INDICADOR LUMINOSO DE TEMPERATURA - WITH TEMPERATURE INDICATOR LIGHT



UN	PRECIO
4	32,28 €

SOPORTES DUCHA



Ref.: HBQUBACR
Descripción:
Barra deslizante Qu,
diámetro 25
de longitud 66 cm.
Esta barra permite
aprovechar los
agujeros de taladro
existentes
en la pared.

COLOR	PRECIO
BLANCO	11,55 €
CROMO	18,31 €

SOPORTE DUCHA ROTULAR



MODELO	UN	PRECIO
LATON CROMO	12	5,80 €
ABS CROMO	12	2,23 €

SOPORTE DUCHA

Sima



COLOR	UN	PRECIO
CROMO	12	9,35 €
BLANCO	12	2,95 €

SOPORTE DUCHA ROTULAR CON TOMA



MODELO	UN	PRECIO
LATON CROMO	6	10,17 €

CODO MANGO DUCHA



CANT.	PRECIO
12	1,90 €

SOPORTE DUCHA BAYONETA



UN	PRECIO
6	8,13 €

BRAZOS DUCHA



JET

UN	PRECIO
6	15,93 €



NORMAL 25 cm

UN	PRECIO
6	7,40 €

ROCIADORES DUCHA

PLASTICO



UN	PRECIO
20	0,78 €

ACERO INOX



UN	PRECIO
12	3,67 €

CON ROTULA



UN	PRECIO
6	11,62 €

ANTIVANDALICO



UN	PRECIO
6	64,83 €

Mangos de Ducha



192 mm.
45 mm.

MODELO	COLOR	CANT.	PRECIO
STANDARD 1	BLANCO	12	3,43 €
STANDARD 1	NEGRO	12	3,43 €
BAJA PRESION 2	NEGRO	12	4,38 €

GOLF



195 mm.
60 mm.

COLOR	CANT.	PRECIO
BLANCO	6	2,34 €
NEGRO	6	2,34 €



111

1 POSICION ANTICAL Cromo

CANT.	PRECIO
6	4,83 €

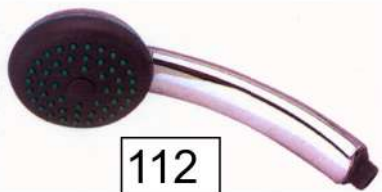

112

1 POSICION ANTICAL Cromo

CANT.	PRECIO
6	5,40 €



Bari

3 FUNCIONES AUTOLIMPIABLE Cromo

CANT.	PRECIO
6	6,95 €

3 FUNCIONES AUTOLIMPIABLE Cromo

CANT.	PRECIO
6	11,09 €



Tiare

4 FUNCIONES AUTOLIMPIABLE Cromo Satinado

CANT.	PRECIO
6	13,49 €

412



Blu Plus

5 POSICIONES AUTOLIMPIABLE Cromo

CANT.	PRECIO
6	16,16 €



LUXOR HIGH PERFORMANCE

6 FUNCIONES AUTOLIMPIABLE

COLOR	UN	PRECIO
BLANCO	6	19,53 €



PIN

1 POSICION ANTICAL Cromo

COLOR	UN	PRECIO
CROMO	3	12,20 €

NOVEDAD 2005

Mango ducha redondo, Ø 15 cm.



PON

3 POSICIONES ANTICAL Cromo

COLOR	UN	PRECIO
CROMO	3	13,55 €

NOVEDAD 2005

Mango ducha redondo, Ø 15 cm.

Filtro URINARIO acero inoxidable
Urinal filter stainless steel
Grille urinoir acier inox.

cromo chrome
chrome chromé

52604

granel bulk
vrac



43 mm
18 mm

UN	PRECIO
6	2,62 €

INVERSOR ANTAO



1/2" 1/2" 90

PRECIO
40,53 €

No 234

ERGOS

COLUMNA TELESCÓPICA DUCHA ERGOS CON TERMOSTÁTICA

- Grifería termostática con mando de caudal y distribuidor en el mismo mando
- Extensible: 800-1350 mm.
- Todos los tubos y soportes a pared son de latón cromado
- Rociador redondo Ø20 cm. con membrana anti-cal
- Manual de ducha con membrana anti-cal
- Flexo de acero reforzado
- Soporte manual de ducha deslizante

UN	PRECIO
1	203,66 €

Girando el volante de caudal hacia la izquierda el agua mana del gran rociador superior. Girándolo hacia la derecha el agua mana del manual de ducha. El mismo giro permite también regular el caudal del agua; cuanto mas se gire más caudal se obtiene.



Columna Telescópica Ducha ERGOS con Monomando

- Extensible: 800-1350 mm.
- Todos los tubos y soportes a pared son de latón cromado
- Rociador redondo Ø20 cm. con membrana anti-cal
- Manual de ducha con membrana anti-cal
- Flexo de acero reforzado
- Soporte manual de ducha deslizante



UN	PRECIO
1	162,15 €

Columna Telescópica Baño OMNIA con Monomando

- Extensible: 800-1350 mm.
- Todos los tubos y soportes a pared son de latón cromado
- Rociador redondo Ø20 cm. con membrana anti-cal
- Manual de ducha con membrana anti-cal
- Flexo de acero reforzado
- Soporte manual de ducha deslizante



UN	PRECIO
1	235,22 €

hidro columnas



Sistema de ducha

LUK

5 jets antical / antilime



22303
Cromo

Ø 200 mm

PRECIO
249,38 €



folk

Compuesta por un rociador cuadrado de gran área de rociado y un mango de ducha cuadrado. La selección de una opción u otra se realiza mediante la válvula intercambiadora que incorpora el set.

Características técnicas:
Columna y válvula fabricadas en latón.
Rociador, mango de ducha, y cursor fabricados en A.B.S. Jaborera de material plástico.
Dos flexibles metálicos. Medidas: 1,5 m y 0,70 m.
Longitud total conjunto: 102 cm.
Ancho aproximado conjunto: 49,5 cm.
Rociador anticálculo: 18 x 18 cm.
Ducha anticálculo: 22 cm.
No incluye grifería.

Column shower consists of square shaped rain overhead and a square handshower. The change of the two functions is made with a three-way valve which is included in the set.

Technical specifications:
Column and valve made of brass.
Overhead and handshower made of A.B.S.
Soap dish made of plastic.
Two metallic shower hoses. Length: 1,5 m and 0,70 m.
Column total length: 102 cm.
Column approximated width: 49,5 cm.
Anti-lime overhead: 18 x 18 cm.
Anti-lime handshower: 22 cm.
Faucet not included.

Ref.	Color / Colour	Cod. Barras / Bar Code	U/caja / U箱	€/ Ud.
22981014	Cromo/Chrome	8410787027114	2	199,26 €

SKARA

COLUMNA TELESCÓPICA DUCHA SKARA CON TERMOSTÁTICA

- Grifería termostática con mando de caudal y distribuidor en el mismo mando
- Extensible: 700-1240 mm.
- Todos los tubos y el soporte a pared son de latón cromado
- Rociador cuadrado de 20 x 20 cm. con membrana anti-cal
- Manual de ducha con membrana anti-cal
- Flexo de acero reforzado
- Soporte manual de ducha deslizante
- Empaquetada en caja de cartón a todo color

PRECIO
235,13 €

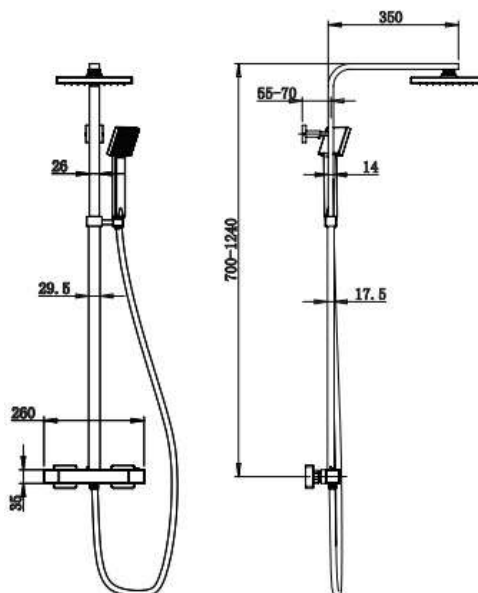

Girando el volante de caudal hacia la izquierda el agua mana del gran rociador superior. Girándolo hacia la derecha el agua mana del manual de ducha. El mismo giro permite también regular el caudal del agua: cuanto mas se gire más caudal se obtiene.

No 236

COLUMNAS DE HIDROMASAJE

Onna

	PRECIO
MONOMANDO	331,21 €
TERMOESTATICA	387,45 €



Ref.: HCHIONNI

Grifo monomando con
cartucho cerámico

Presión mínima: 0,8 bar, presión máxima: 5 bar
Presión recomendada de funcionamiento: de 1,5 a 3 bar
Columna en acero inoxidable aisi 304 con tratamiento antihuellas
3 años de garantía
3 funciones: mango de ducha, rociador y jets de masaje horizontal
Jets y mango de ducha anticalcareos
Flexo de ducha de acero inoxidable, doble grapado de 150 cm



Ref.: HCHTONNI

Grifo con cartucho
termostático

Handle tap with
thermostatic cartridge



Ref.: HCHIEDNI

Grifo monomando con
cartucho cerámico

Single handle tap with
ceramic cartridge

Edna

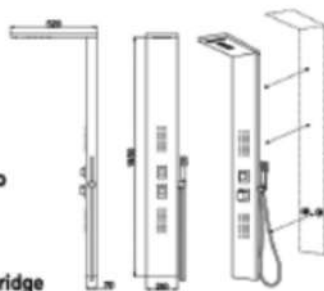

Ref.: HCHTEDNI

Grifo con cartucho
termostático

Handle tap with
thermostatic cartridge

E

Presión mínima: 0,8 bar, presión máxima: 5 bar
Presión recomendada de funcionamiento: de 1,5 a 3 bar
Columna en acero inoxidable aisi 304 con tratamiento antihuellas
3 años de garantía
3 funciones: mango de ducha, rociador y jets de masaje horizontal
Jets y mango de ducha anticalcareos
Flexo de ducha de acero inoxidable, doble grapado de 150 cm

	PRECIO
MONOMANDO	334,45 €
TERMOESTATICA	413,24 €

No 238

ACCESORIOS DE BAÑO

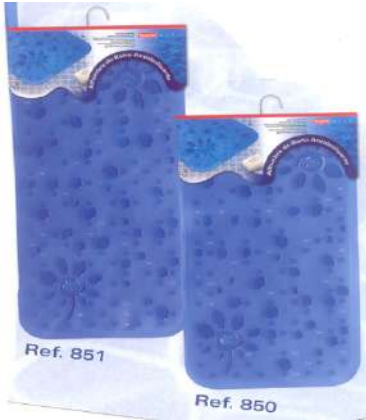

ALFOMBRAS

MEDIDAS	ENVASE	PRECIO
37 x 90	6	11,62 €
34 x 58	6	9,83 €
54 x 54	6	12,83 €
Ducha		
100 X 60	6	21,50 €
Recortable		
60 x 60	6	14,75 €
Ducha Angular		



Colores: **Azul , Beige y Blanco**



CORTINAS

Medidas **180 X 180**

COLOR	ENVASE	PRECIO
Blanco	6	11,38 €
Azul Claro	6	11,38 €
Estampado	6	12,50 €

BARRAS Y RIELES BAÑO / DUCHA



RIEL MULTIFORM

Riel con cuatro opciones diferentes de montaje.

Medida 80 x 170 cm

Incluye todas las piezas necesarias para su instalación.

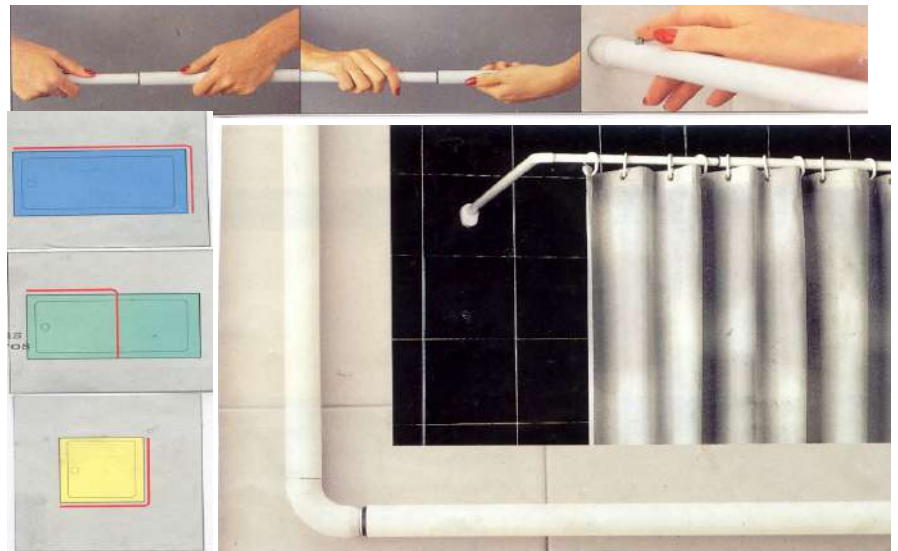

CODIGO	MODELO	UN	PRECIO
BB050302	ANGULAR 70x114-190 cm	4	25,12 €
BB050102	RECTA 105-170 cm	6	20,50 €
BB050202	RECTA 150-215 cm	6	22,17 €

CODIGO	UN	PRECIO
BB050302	6	30,53 €

Asiento Ducha Plegable INOX

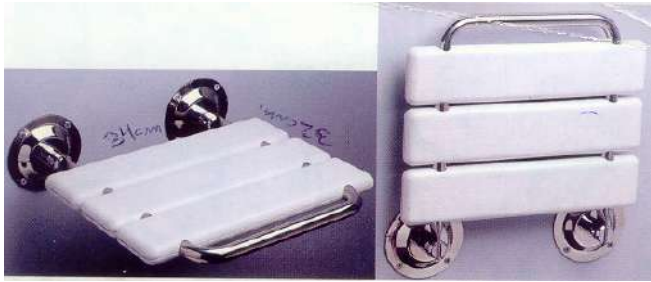

Acero Inoxidable 18/8, tablas de plástico ABS
Incluye barraqueros también inox
Ocasionalmente puede servir como asidero

CANT.	PRECIO
2	94,95 €



Asiento Ducha Plegable INOX con soporte a pared

CANT.	PRECIO
2	98,60 €



Asiento Ducha Plegable

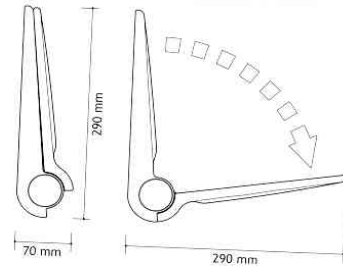

Sento

Asiento abatible. Color blanco. Material termoplástico. Peso 2380kg.
Resistencia máxima 200 kg.

CANT.	PRECIO
2	75,55 €



Asiento Bañera



MODELO	UN.	PRECIO
ARMAZON ACERO INOXIDABLE	2	71,12 €
ARMAZON CROMADO / MADERA NATURAL	2	80,00 €

TLL-01

Toalleros Bajo Encimera

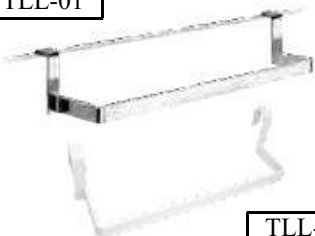

TLL-02

MODELO	PRECIO
TLL-01	18,13 €
TLL-02	17,35 €

ASIENTO GIRATORIO DE BAÑERA



AB - 1005

CANTIDAD	PRECIO
3	180,00 €

ASIENTO DUCHA REGULABLE



En aluminio y regulable en altura

CANTIDAD	PRECIO
2	52,76 €
4	50,69 €

ASIENTO DUCHA REGULABLE REDONDA



- Banqueta para baño regulable en altura.
- Regulación en altura: e 36 cm a 53 cm,
- Fabricación en Aluminio y PE de alta densidad.
- Acabado del asiento color blanco.
- Acabado de las patas en Aluminio.
- Superficie antideslizante.
- Tapones de goma antideslizante en los extremos de las patas.

CANTIDAD	PRECIO
2	50,30 €

BANQ15 - BLANCO / ALUMINIO

PE Alta Densidad / Aluminio HD PE / Aluminio

-A 320 mm -C 360 mm
-B 320 mm -D 530 mm



ASIENTO DUCHA REGULABLE con REPOSABRAZOS



- Silla para baño regulable en altura: 41 a 54 cm
- Dotada de reposabrazos y respaldo regulable en profundidad: de 4 a 54 cm.
- Fabricación en Aluminio y PE de alta densidad
- Asiento acabado en color Blanco y patas regulables en aluminio (Asiento: 40 x 33 cm)
- Tapones de goma antideslizante en los extremos de las patas
- Asiento con orificios de drenaje para evitar el estancamiento de las gotas de agua.

CANTIDAD	PRECIO
2	117,13 €

Dimensiones

-A 450 mm -C 730 mm
-B 490 mm -D 860 mm
-B' 540 mm



SILLA DE RUEDAS PARA BAÑO



PRECIO
395,85 €



- Silla de ruedas plegable para Baño, usos indicados:
- Sobre INODORO, extrayendo la cubeta
- En el interior de la DUCHA, cubeta incluida.
- Incluye reposapiés abatible y asiento inodoro con cubeta extraíble.
- El plegado de la silla facilita su guardado mientras no se use.
- Fabricado en acero inoxidable brillo.**

DIMENSIONES
DIMENSIONES -A: 480 mm -a: 480 mm
-B: 880 mm -b: 710 mm
-C: 1.020 mm -c: 495 mm



ASIENTO INODORO ELEVADO 10 CM



	MODELO	PRECIO
	CON TAPA	51,78 €
	SIN TAPA	43,60 €

DESCUENTO 5% PARA 4 UNIDADES

No 244

Tapa-Asiento Inodoro Universal LUXE



CODIGO	COLOR	UN	PRECIO
50.T-60.00	Blanco	10	26,27 €

El diseño anatómico de esta tapa le proporcionará un gran confort.

Sistema de bisagras correderas adaptable a las diferentes medidas de inodoro.

Fabricada en Poliprolileno



Cod.	Asiento de inodoro compatible con mod. GAP de DUROPLAST con SOFT CLOSE
30710	

UN	PRECIO
1	47,46 €



- Fabricado en DUROPLAST
- Herrajes ACERO INOXIDABLE 360°
- Adaptable
 - Modelo Meridian de Roca
- QUICK RELEASE
 - Montaje y desmontaje del asiento rápido y sencillo
 - Facilidad de limpieza
- SOFT CLOSE: caída amortiguada
- Peso: 2300 g • Color: blanco

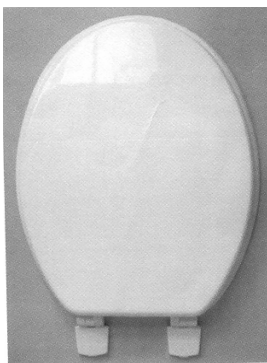
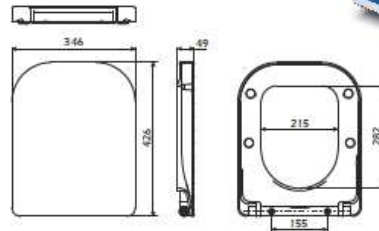

Tapa-Asiento Inodoro Madera Maciza Universal

CODIGO	COLOR	CANTIDAD	PRECIO
0746000090	Lacada Blanco MDF con tornillos acero inox	5	35,10 €
		3 cajas	Dto. 5%

**Especial
DAMA**

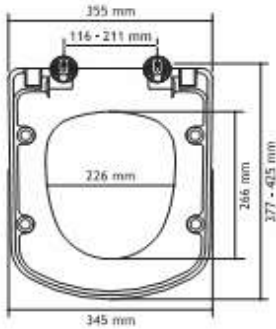

UN	PRECIO
5	60,99 €

Tonda Softclose

Ref.: 12801
Blanco / White / Blanc
Duroplast
Bisagra / Hinge / Charnière:
Inox
Peso / Weight / Poids: 2775 g
Caja



Con tratamiento antimicrobiano.
With antimicrobial treatment.
Avec traitement antimicrobien.

**Envase
5%
Descuento**



SOFTCLOSE

- Sistema que ralentiza la caída de la tapa y el aro.
- Más silencioso, higiénico y confortable.
- Evita golpes, ruidos y atrapamientos.
- Totalmente integrado.

DUROPLAST

- Mezcla en polvo de resina y celulosa conformada por presión a alta temperatura.
- Material uniforme. No cambia de color en caso de golpe o rallado.
- Aspecto cerámico.
- Gran resistencia superficial al rallado y abrasión.
- Fácil de limpiar.
- Antiestático y repele el polvo.
- Color inalterable.



Cod.	
30709	Asiento de inodoro SLIM de DUROPLAST con SOFT CLOSE

- Fabricado en DUROPLAST
- Herrajes ACERO INOXIDABLE 360°
- Adaptable
 - Modelo Victoria de Roca
 - Otros modelos de gama económica del mercado
- QUICK RELEASE
 - Montaje y desmontaje del asiento rápido y sencillo
 - Facilidad de limpieza
- SOFT CLOSE: caída amortiguada
- Peso: 2600 g • Color: blanco

**PRODUCTO
NUEVO**

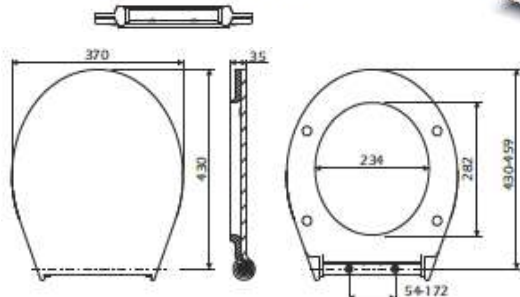

UN	PRECIO
1	54,50 €

Cod.	Asiento de inodoro de DUROPLAST con QUICK RELEASE
30703	



- Adaptable
 - Modelo Victoria de Roca
 - Otros modelos de gama económica del mercado
- QUICK RELEASE
 - Montaje y desmontaje del asiento rápido y sencillo
 - Facilidad de limpieza
- Peso: 2200 g
- Color: blanco

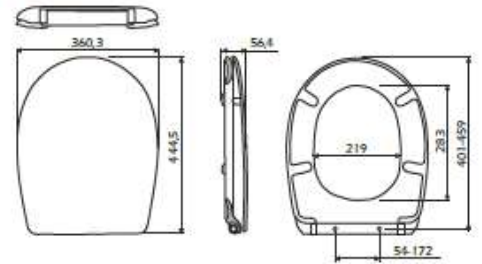

UN	PRECIO
1	45,30 €
10	43,54 €



Ugo

Reductor WC infantil / Toilet training seat
 Adaptable a todos los asientos WC / *Adaptable to all WC seats*
 Ref.: 14101
 Blanco / *White*
 Material: Termoplast
 Peso / *Weight*: 235 g
 Caja / *Box*

UN	PRECIO
3	12,58 €

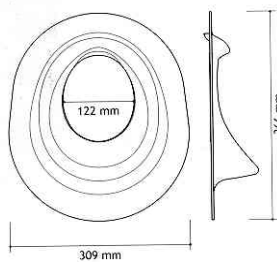

Tarima Plato de Ducha



Tarima TECA CUADRADA



UN	PRECIO
4	37,50 €



UN	PRECIO
4	77,76 €



UN	PRECIO
4	87,27 €



Tarima TECA RECTANGULAR



UN	PRECIO
2	77,76 €



UN	PRECIO
2	89,51 €



UN	PRECIO
2	97,65 €



Tarima TECA CUADRADA ANGULAR

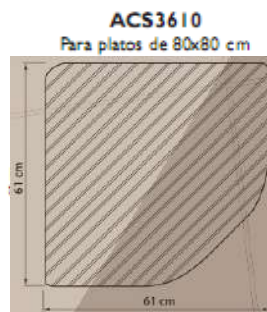

UN	PRECIO
2	77,76 €

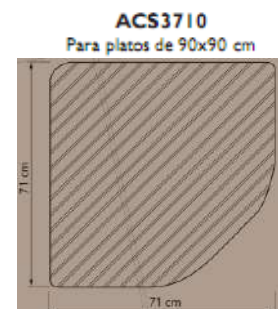

UN	PRECIO
2	87,27 €



Tarima TECA CUADRADA CON ENCAJE

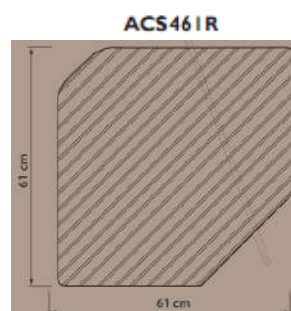

UN	PRECIO
2	77,76 €

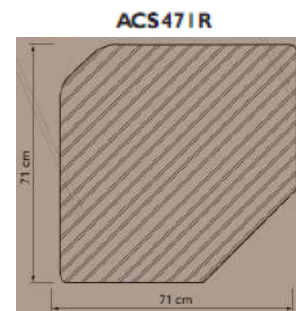

UN	PRECIO
2	77,76 €



Tarima Enrollable de TECA

MEDIDA	UN	PRECIO
120 x 70	2	91,80 €
120 x 80	2	106,65 €

Portarrollos



COLOR	PRECIO
Blanco - Blanco	12,55 €
Blanco - Cromo	10,94 €

Jabonera



COLOR	PRECIO
Blanco - Blanco	5,20 €
Blanco - Cromo	4,87 €

Portavasos



COLOR	PRECIO
Blanco - Blanco	5,53 €
Blanco - Cromo	6,14 €

Toallero Anilla



COLOR	PRECIO
Blanco - Blanco	6,08 €
Blanco - Cromo	6,58 €

Toallero Barra



COLOR	PRECIO
Blanco - Blanco	10,38 €
Blanco - Cromo	9,76 €

Repisa



COLOR	PRECIO
Blanco - Blanco	10,54 €
Blanco - Cromo	11,74 €

Percha



COLOR	PRECIO
Blanco - Blanco	3,27 €
Blanco - Cromo	3,87 €

Colores



Blanco

Cromo

Portarrollos



COLOR	PRECIO
Blanco - Blanco	9,97 €
Blanco - Cromo	10,57 €

Jabonera



COLOR	PRECIO
Blanco - Blanco	4,55 €
Blanco - Cromo	5,10 €

Portavasos



COLOR	PRECIO
Blanco - Blanco	5,53 €
Blanco - Cromo	6,05 €

Toallero Anilla



COLOR	PRECIO
Blanco - Blanco	5,27 €
Blanco - Cromo	5,90 €

Toallero Barra



COLOR	PRECIO
Blanco - Blanco	9,32 €
Blanco - Cromo	10,17 €

Repisa



COLOR	PRECIO
Blanco - Blanco	9,58 €
Blanco - Cromo	10,73 €

Percha



COLOR	PRECIO
Blanco - Blanco	3,30 €
Blanco - Cromo	3,90 €

Colores



Blanco

Cromo

ACCESORIOS PARA EL BAÑO



Estuche Conic 6 piezas

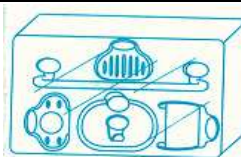

Estuche 6 piezas ELIPSE:

Anilla, barra, portarrollos, portavasos, jabonera y percha

COLOR	PRECIO
Blanco - Blanco	40,83 €
Blanco - Cromo	44,62 €

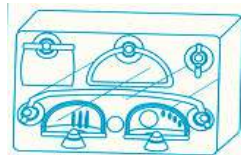

Estuche 6 piezas CONIC:

Anilla, barra, portarrollos, portavasos, jabonera y percha

COLOR	PRECIO
Blanco - Blanco	45,07 €
Blanco - Cromo	48,85 €



Espejo de baño

Medidas: 49 cm ancho x 63 cm. Alto. Contiene todos los elementos necesarios para su instalación. Fabricado en material ABS de primera calidad.

PRECIO

39,04 €

Escobillero rinconera



Escobillero basse

El escobillero BASSE combina perfectamente en todos los ambientes gracias a sus líneas sencillas y funcionales. Fabricado en Polipropileno.

PRECIO

5,98 €

Escobilla suelta

PRECIO

5,00 €



PRECIO

4,25 €



Cubo de baño a pedal

El innovador diseño de este cubo sanitario le permite disfrutar de la máxima capacidad en el mínimo espacio. Su cubeta interior con asa y un pedal antideslizante le aseguran un uso agradable y duradero. Capacidad 8 litros. Fabricado en Polipropileno. Medidas: alto 29 cm. X ancho 21 cms.

8 LITROS
GRAN
CAPACIDAD

PRECIO

10,78 €

Estrella☆
Complements

Colección de Accesorios Baño

B A Ñ O

toyma®

Bathroom Fittings Set

Set d'Accessoires de Salle de Bains

Conjunto de Casa de Banho

Insieme da Bagno

Badezimmer-Set

Набор Аксессуаров для Ванной Комнаты

مجموعة ملحقات الحمام

Ref. 835

PRECIO

20,50 €



PRECIO

14,83 €

Ref. 836



Ref. 832

PRECIO

17,67 €



PRECIO

20,92 €



Ref. 833

PRECIO

19,50 €



Ref. 834

PRECIO

24,50 €



Ref. 837

PRECIO

40,83 €



Ref. 838

Acabados · Finishes · Finitions · Acabamentos
Rifiniture · Angefertigte · Отделка · المنهيات الأخيرة



35
Cromo
Brillo



39
Aluminio
Mate

REF.	Cm.				
832	18 x 8,5 x 17,5	4	0,366	0,013	8414011008320
833	17 x 11,5 x 13,5	4	0,411	0,014	8414011008337
834	16,5 x 10,5 x 14,5	4	0,428	0,013	8414011008344
835	21,5 x 7,5 x 27	4	0,403	0,022	8414011008351
836	13,5 x 7,5 x 13,5	4	0,267	0,008	8414011008368
837	58 x 7,5 x 13	4	0,547	0,029	8414011008375
838	67 x 10,5 x 16	4	1,305	0,060	8414011008382

Latón cromado

UN	PRECIO
4	16,00 €



Percha
Hook
Ref.: 00519
Cromo / Chrome
Caja / Box



Tallero barra
Towel bar
Ref.: 00517
Cromo / Chrome
Caja / Box



UN	PRECIO
4	51,93 €

Envase
5%
Descuento

Toallero barra frontal
Front towel bar
Ref.: 00520
Cromo / Chrome
Caja / Box



UN	PRECIO
4	34,51 €



Nº 254 **02**

Envase
5%
Descuento

Latón Cromado

Anilla Toallero
Towel ring
Ref.: 00515
Cromo / Chrome
Caja / Box

UN	PRECIO
4	37,00 €

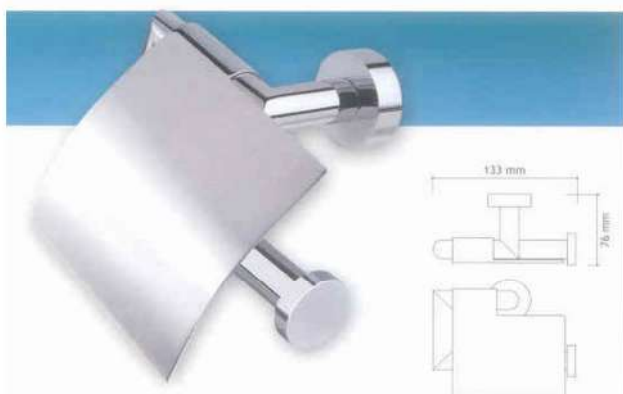

Portarrollos
Toilet roll holder
Ref.: 00516
Cromo / Chrome
Caja / Box

UN	PRECIO
4	45,95 €



Portarrollos repuesto
Toilet roll holder
Ref.: 00518
Cromo / Chrome
Caja / Box



UN	PRECIO
4	27,05 €

Nº 254 03

SERIE COMFORT INOXIDABLE	PRECIO
--------------------------	--------



XACOTORO

TOALLERO ARO "COMFORT" INOX	22,05 €
-----------------------------	----------------



XACOPOTO

PORTATOALLAS "COMFORT" INOX	87,39 €
-----------------------------	----------------



XACOESPA

ESCOBILLERO PARED "COMFORT" INOX	57,75 €
----------------------------------	----------------

SERIE DYNAMIQUE LATON	PRECIO
-----------------------	--------



XADYTOB4

TOALLERO BARRA 45 "DYNAMIQUE" LATON	27,76 €
-------------------------------------	----------------



XADYTOAR

TOALLERO ARO "DYNAMIQUE" LATON	17,51 €
--------------------------------	----------------



XADYPORT

PORTARROLLOS C/TAPA "DYNAMIQUE" LATON	30,39 €
---------------------------------------	----------------



XADYPOVA

PORTAVASOS "DYNAMIQUE" LATON	20,36 €
------------------------------	----------------



XADYPERC

PERCHA "DYNAMIQUE" LATON	10,78 €
--------------------------	----------------



XADYPOTO

PORTATOALLAS "DYNAMIQUE" LATON	79,71 €
--------------------------------	----------------



XADYESPA

ESCOBILLERO PARED "DYNAMIQUE" LATON	25,90 €
-------------------------------------	----------------

08/04/2021

ACCESORIOS BAÑO

Serie "KUN"



REFERENCIA	DESCRIPCION	PRECIO
XAKUTOB4	TOALLERO BARRA 40 cm	22,42 €



REFERENCIA	DESCRIPCION	PRECIO
XAKUTBD5	TOALLERO DOBLE 45 cm	32,10 €



REFERENCIA	DESCRIPCION	PRECIO
XAKUTOAB	TOALLERO ABIERTO	17,41 €



REFERENCIA	DESCRIPCION	PRECIO
XAKUPORT	PORTARROLLOS	19,55 €



REFERENCIA	DESCRIPCION	PRECIO
XAKUPERC	PERCHA	8,55 €



REFERENCIA	DESCRIPCION	PRECIO
XAKUPERD	PERCHA DOBLE	20,03 €

ACCESORIOS BAÑO

Serie "FILO"



REFERENCIA	DESCRIPCION	PRECIO
XAFITOB4	TOALLERO BARRA 40 cm	39,66 €



REFERENCIA	DESCRIPCION	PRECIO
XAFITBD5	TOALLERO DOBLE 45 cm	60,83 €



REFERENCIA	DESCRIPCION	PRECIO
XAFITOAB	TOALLERO ABIERTO	28,65 €



REFERENCIA	DESCRIPCION	PRECIO
XAFIPORO	PORTARROLLOS SIN TAPA	21,05 €



REFERENCIA	DESCRIPCION	PRECIO
XAFIPORT	PORTARROLLOS CON TAPA	32,07 €



REFERENCIA	DESCRIPCION	PRECIO
XAFIPERC	PERCHA	16,19 €



Aqua 601

Medida	Precio
23 x 10	23,88 €



Aqua 602

Medida	Precio
30 x 13	40,09 €



Aqua 603

Medida	Precio
24 x 20	23,75 €



Aqua 604

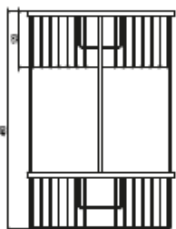

Medida	Precio
24 x 20 x 34	60,49 €



Aqua 701

Medida	Precio
24 x 15 x 14	45,15 €



Aqua 606

Medida	Precio
20 x 18 x 44	80,80 €



Aqua 702

Medida	Precio
30 x 13 x 14	49,69 €



Rejilla ovalada para colgar en grifo

Acero Inox AISI 304





Precio
35,01 €



Espejo orientable de aumento

Precio
35,00 €

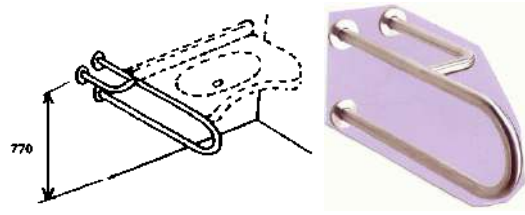
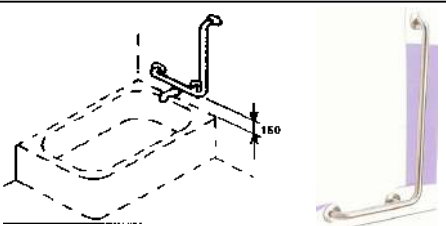
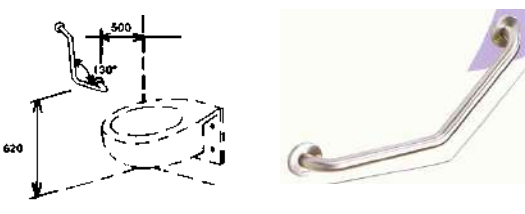
Barras Minusvalía

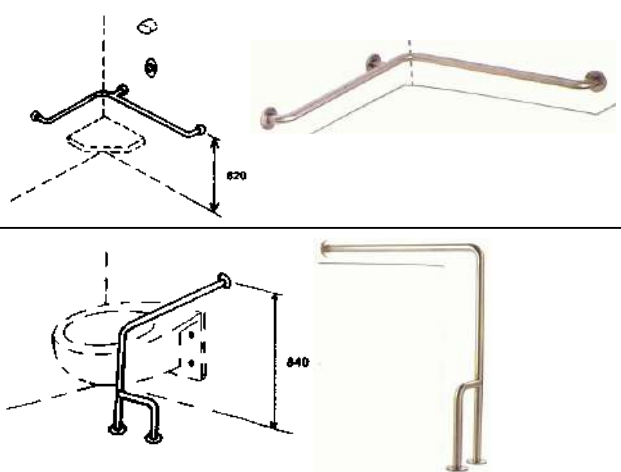
		PRECIO
DESCRIPCION		Inox Brillo
	Barra recta de 300mm	25,63 €
	Barra recta de 500mm	30,00 €
	Barra recta de 800mm	47,73 €
	Barra recta con 3 puntos de anclaje de 1220mm x 320 mm	Inox Satinado 113,33 €
	Barra fija con 3 puntos de anclaje, apoyo derecho , de 600mm	Inox Satinado 80,00 €
	Idem apoyo izquierdo	80,00 €
	Barra ángulo derecho 90° - 400 x 750mm	Inox Satinado 69,17 €
	Barra ángulo izquierdo 90° - 400 x 750mm	69,17 €
	Barra en ángulo de 130°	Inox Brillo
	Ø 25 x 457 Brillo	33,80 €
	Barra mural abatible en giro vertical, de 750mm con portarrollos.	Inox Brillo 111,33 €
	Barra horizontal mural a DOS paredes de 700 x 700 mm.	Inox Brillo 80,00 €
	Barra de pared a suelo con TRES anclajes, a derecha , de 850 X 750 mm.	Inox Brillo 110,25 €
	Idem a izquierda	110,25 €



J1T 20,80 €

Depósito: Transparente.
Tapa/pulsador: Blanco.
Dim.: 210 x 90 x 110 mm.



J1B 28,33 €

Depósito: Blanco.
Tapa: Blanca.
Pulsador: Gris.
Dim.: 225 x 132 x 95 mm.



Cod. 71028
Modelo vertical
Material: Acero Inoxidable AISI304
Acabado: Satinado
Valvula anti-goteo
Visor de llenado
Capacidad: 1,2 litros
Colocación: Adosado en la pared
Dimensiones sin válvula: 208 x 121 x 70 mm

J3V

½ litro **39,55 €**
1 litro **43,25 €**



Cod.: 71016
Serie Contura
Cabezal de acero inox AISI 304 brillante
Vastago: ABS negro
Depósito: Polietileno blanco
Cierre de seguridad
Capacidad: 1 litro. Rellenable por arriba
Colocación: encastrado en encimera
Diámetro orificio encimera: 25 mm
Longitud del pico: 100 mm
Altura vastago: 100 mm
Altura depósito: 245 mm
Diam. Tapa embell.: 50 mm

B-822

½ litro **23,45 €**
1 litro **77,83 €**



J7ABA 103,33 €

Acabado embellecedor
Aluminio satinado.
Funcionamiento: Automático. Sensor electrónico. 6 pilas 1,5 V no incluidas.
Dimensiones: 220 x 143 x 116 mm.



MAFS 403,33 €

Carcasa: Aluminio inyectado.
Acabado Carcasa: Cromado satinado.



Funcionamiento: Sensor electrónico
Dimensiones: 272 x 226 x 165 mm.
Peso: 3,2 kg.
Potencia: 1100 W.
Anti-vandálica.



Con tecnología antibacteriana
SteriTouch®
Sin resistencia
34.000 RPM.
Ahorro: 75 % de energía
Secado en 12 segundos

SM002IB



Secador de manos de pulsador
Fabricado en acero inox brillo
Potencia Nominal: 2300 W
Voltaje/Frecuencia 230V / 50Hz
Grado protección: IPX1
Flujo Aire: 22 m/s
Incluye fijaciones
Medidas: 275 x 200 x 230 mm

279,90 €

SM002AM



Secador de manos automático
Fabricado en aluminio satinado
Potencia Nominal: 2550 W
Voltaje/Frecuencia 230V / 50Hz
Grado protección: IPX1
Flujo Aire: 24 m/s
Sensor de detección por infrarrojos
Distancia de detección regulable
Incluye fijaciones
Medidas: 265 x 210 x 240

229,90 €

Dispensadores papel higiénico
inox industrial

Papel industrial. Rollo tipo bobina 250/300 m.
Dimensiones: 273,5 x 270 x 132 mm. / eje: 44 mm. Ø
Con visor de contenido y cierre de seguridad.



HIS 55,00 €

Material: Acero inoxidable AISI 304.
Acabado: Satinado



D - 106 CS

Cod.: 73015CS
Material: Acero Inox AISI 304
Acabado: Satinado
Visor de llenado
Cierre de seguridad con llave Mediclinis
Capacidad: 400/500 servicios
Dimensiones: 330 x 275 x 133 mm

61,75 €

CAMPAÑA DE PREVENCIÓN DE LA GRIPE A (H1V1)

**MODELOS RECOMENDADOS:
J7ABA // MAFS**



ROLL02 Portarrollos exterior

CODIGO	PRECIO
ROLL02	21,58 €



ROLL01 Portarrollos empotrable

CODIGO	PRECIO
ROLL01	21,63 €



ESC01 Escobillero

PRECIO
34,23 €



TEN01 Tendedero cuerda extensible

CODIGO	PRECIO
TEN01	16,12 €



Cubo Inox

CODIGO	MODELO	PRECIO
CUBO5L	5 litros	24,90 €
CUBO12L	12 litros	46,40 €



Lavabo inox

MEDIDA (mm)		PRECIO
Exterior		
360		87,08 €
410		94,50 €



Toallero Barra Doble Giratorio 42 cm

CODIGO	PRECIO
CLA05	21,35 €

REFERENCIA	ACABADOS	MATERIAL	DIMENSIONES
BAS02	- CRISTAL+SATINADO / GLASS & MATT	Cristal / ABS / Acero Inoxidable Glass / ABS / Stainless Steel	- A: 325 mm - B: 325 mm - C: 40 mm

- Báscula de Cristal para Baño, de forma semiovalada
 - Plataforma fabricada en Cristal templado de alta resistencia, de 8 mm de espesor. Componentes metálicos en Acero Inoxidable con acabado Satinado, carcasa en ABS
 - Presentación de la información en display LCD de alta resolución, con 4 dígitos
 - Lector de peso en kilogramos y en libras
 - Capacidad máxima: 180 kg (396 lb)
 - Precisión de pesada: 0,1 kg (0,2 lb)
 - Sistema de ahorro de batería por autoapagado

C: Altura / Height

PRECIO
37,62 €

Báscula Plataforma de Cristal para Baño
Glass Personal Platform Scale



PARAGUAS DUCHA
Soporte plástico y varillas acero inox

Paraguas Ducha

CODIGO	CANT.	PRECIO
DUC3008	2	46,62 €

DOSIFICADOR PARA BAÑO

"GAUDI" BATH DOSAGE MEASURER
 DOSEUR "GAUDI" POUR SALLE DE BAINS • DOSIFICADOR DE BANHO "GAUDI"
 DOSIFICATORE DA BAGNO "GAUDI"
 BADEZIMMERDOSIERER "GAUDI"

REF. 710
715 720

BAÑO



REF. 710

DOSIFICADOR GEL GAUDI SIMPLE
 "GAUDI" SINGLE NOZZLE LIQUID SOAP DISPENSER
 DOSEUR GEL "GAUDI" Simple
 DOSIFICADOR DE GEL "GAUDI" Simple
 DOSATORE PER GEL "GAUDI" Semplice
 "GAUDI"- GELSPENDER, EINFACH



REF. 715

DOSIFICADOR DOBLE DE BAÑO GAUDI
 "GAUDI" BATH DOSAGE MEASURER - double
 DOSEUR "GAUDI" POUR SALLE DE BAINS - double
 DOSIFICADOR DE BANHO "GAUDI" - duplo
 DOSIFICATORE DA BAGNO "GAUDI" - doppio
 BADEZIMMERDOSIERER "GAUDI" - doppelt

Para Gel y Champú
 For Gel and Shampoo
 Pour Gel et Shampouing
 Para Sabão Líquido e Shampoo
 Per Gel e per Sciampo
 Für Gel und Shampoo

UN	PRECIO
6	16,58 €



10

BLANCO



REF.	Cm.				
710	19 x 11 x 19	6	4'887	V: 0,034 m ³	8414011007101
715	27,5 x 11 x 19	6	5'700	V: 0,051 m ³	8414011007156
720	36 x 11 x 19	6	7'290	V: 0,064 m ³	8414011007200

No 273

MONTURAS



NORMAL

MEDIDAS	ENVASE	PRECIO
16 - 150	12	8,12 €
17 - 150	12	8,12 €
18 - 150	12	8,12 €
19 - 150	12	8,12 €
20 - 150	12	8,12 €
21 - 150	12	8,12 €
22 - 150	12	8,12 €
3/8"	12	8,12 €
1/2"	12	8,12 €



EMPOTRAR

MEDIDAS	ENVASE	PRECIO
16 - 150	6	11,24 €
17 - 150	6	11,24 €
18 - 150	6	11,24 €
19 - 150	6	11,24 €
20 - 150	6	11,24 €
21 - 150	6	11,24 €
22 - 150	6	11,24 €
3/8"	6	11,24 €
1/2"	6	11,24 €

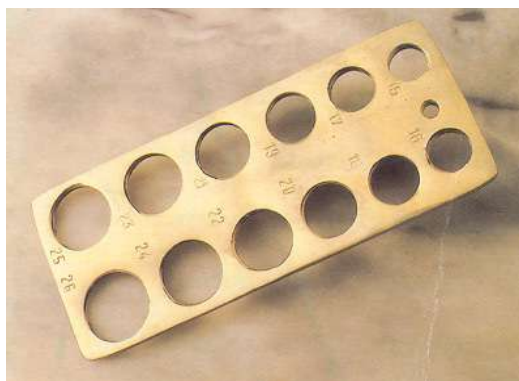

PLACA MEDIDORA DE MONTURAS

ENVASE	PRECIO
1	68,36 €

Ducha Solar



PRECIO
893,00 €

Con la ducha solar ya puede disfrutar de lo agradable de una ducha al aire libre, con la posibilidad de elegir la temperatura deseada, mediante los mandos de agua fría y agua caliente.

En la ducha solar, se calienta el agua, manteniéndolo almacenado en su propia columna de 30 litros de capacidad y que gracias a su poder de captación solar y conductividad térmica (compuesta de aluminio, Magnesio y Poliester con partículas metálicas). El agua puede alcanzar en muy poco tiempo temperaturas de hasta 60 °C. Permitiendo así ser utilizada por varias personas durante todo el día y todo sin consumo de energía, más que la que proporciona gratuitamente el sol. A diferencia de cualquier otro aparato solar, esta ducha, tiene la propiedad de captar la temperatura ambiente por lo que podemos utilizarla en días nublados o de escasa luz solar. También es útil en piscinas públicas, hoteles, polideportivos, playas, etc. Producto de alta calidad en acero inoxidable que soporta muy bien los ambientes marinos.



Entrada para WC y una toma lateral de Ø 40 mm para la conexión de un aparato sanitario.
Entrada para a sanita e uma abertura lateral de Ø 40 mm para a ligação de um dispositivo sanitario.

Impulsión hasta 5 m en vertical, ó 52 m en horizontal.

Altura máxima de bombagem 5 m na vertical ou 52 m na horizontal.

Disponibile en una amplia gama de colores.
Disponível numa ampla gama de cores.

Sistema Caset, permite un fácil desmontaje y limpieza.

Sistema de Cassete. Permite um desmontagem e limpeza fáceis.

Reducidas dimensiones. / *Dimensões reduzidas.*

Stencioso. / *Silencioso.*



COLOR	REFERENCIA	UN	PRECIO
BLANCO	75301	1	693,88 €



PRECIO
740,00 €

Evacuación vertical: Hasta 5 m

Evacuación horizontal:
Hasta 100 m
(con una pendiente de 1%)

Entradas: 1 frontal + 1 superior

Diámetros codo de salida:
22/28/32 mm

Diámetro de evacuación recomendado: 32 mm

Temperatura admisible de las aguas usadas: 38° C

Tensión de alimentación:
220-240 V / 50 Hz

Consumo motor: 400 W

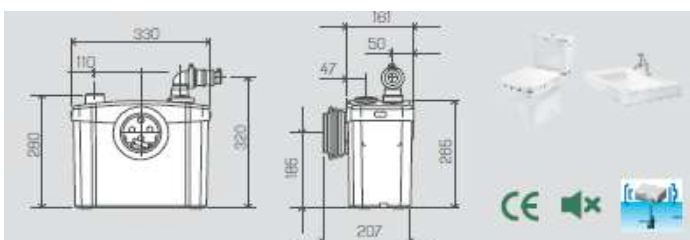

PRECIO
913,00 €

Evacuación vertical: Hasta 5 m

Evacuación horizontal:
Hasta 100 m
(con una pendiente de 1%)

Entradas: 1 frontal + 1 superior + 2 laterales

Diámetros codo de salida:
22/28/32 mm

Diámetro de evacuación recomendado: 32 mm

Temperatura admisible de las aguas usadas: 38° C

Tensión de alimentación:
220-240 V / 50 Hz

Consumo motor: 400 W

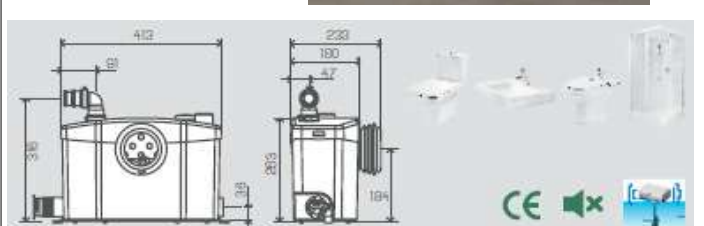

Grifería Temporizada

GRIFOS PEDAL



**1 PEDAL
AGUA FRIA**

MEDIDA	PRECIO
1/2"	85,13 €



**1 PEDAL
AGUA FRIA Y CALIENTE**

MEDIDA	PRECIO
1/2"	101,12 €

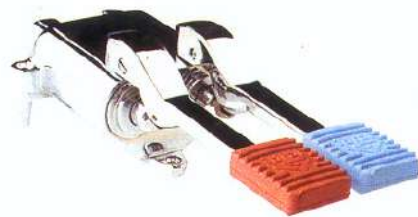

**2 PEDALES
AGUA FRIA Y CALIENTE**

MEDIDA	PRECIO
1/2"	154,82 €

GRIFO EMPOTRAR Novo Tempus para URINARIO o DUCHA



MEDIDA	PRECIO
1/2"	59,25 €

PULSADOR DE PIE TEMPUS



MEDIDA	PRECIO
10mm	119,64 €

CAÑO GIRATORIO VERTICAL CROMADO para GRIFOS PEDAL y PULSADOR



MEDIDA	PRECIO
1/2"	63,83 €

FLUXOMETRO WC Novo Tempus



VISTO

MEDIDA	PRECIO
1"	71,42 €
3/4"	67,63 €



EMPOTRAR

MEDIDA	PRECIO
3/4"	72,98 €
1"	94,76 €

TUBO TELESCOPICO DESCARGA FLUXOMETROS



Ø	PRECIO
32	39,30 €
25	33,36 €

Grifería Temporizada

- Mecanismo de cierre de fácil regulación a voluntad.
- Filtro de acero inox. Incorporado y de sencillo manejo.

GRIFO LAVABO



CANT.	PRECIO
2	59,17 €

GRIFO FRONTAL



MEDIDA	PRECIO
1/2"	55,46 €

MONTURA



PRECIO
37,91 €

GRIFO URINARIO



CANT.	PRECIO
2	71,82 €

GRIFO URINARIO / DUCHA VISTO



CANT.	PRECIO
2	59,56 €

GRIFO FUENTE



Regulado a 6 segundos

MEDIDA	UN	CROMADO	LATON
1/2"	2	54,13 €	45,15 €
3/4"	2	96,84 €	50,75 €



Grifo Lavabo 2 aguas "ELECTRA"

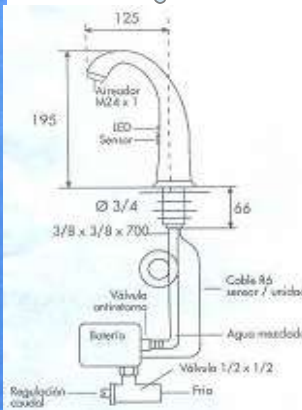

- CARACTERÍSTICAS**
- Ideal para hoteles, oficinas, centros de salud, hospitales, sector alimentario y otros establecimientos públicos.
 - Cuerpo fundido de latón, con acabada en cromo brillante.
 - Sistema de seguridad de autobloqueo al mixto de uso interrumpido.
 - El piloto (LED) parpadeará durante un mes cuando la batería esté baja.
 - Caudal regulable.
 - Campo del sensor infrarrojo preajustado a 1,7 m.
 - Diseño antirrobado, hermético, todas las partes electrónicas son resistentes al agua.

PRECIO
315,80 €

- ESPECIFICACIONES**
- Batería: CR P2 DC6V Litio. 1 Unidad. Duración: 3 años (a razón de 50.000 usos por año).
 - Presión de trabajo: Desde 0,5 a 8 Bar.
 - Rango de Sensibilidad: No Ajustable.
 - Provisión Tuberia: Rosca 1/2"
 - Temperatura del Agua: 1 - 80° C.
- Grifo lavabo 2 Aguas "ELECTRA"



Grifo Urinario Visto "ELECTRA"

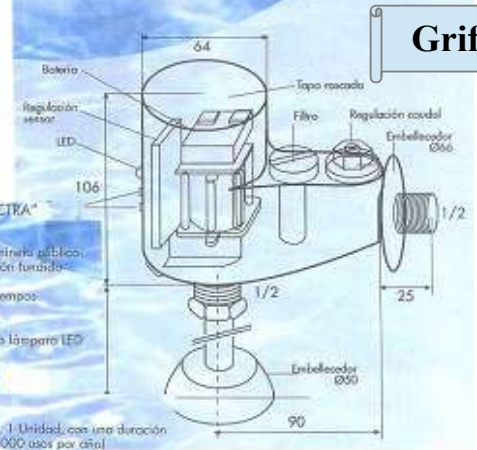

- Grifo Urinario Visto "ELECTRA"**
- CARACTERÍSTICAS**
- Ideal para cualquier establecimiento público.
 - El cuerpo está fabricado en latón fundido para una mayor durabilidad.
 - Descarga automática en dos tiempos para una mayor higiene.
 - Diseño especial antirrobado.
 - Cuando la batería está baja, la lámpara LED emite una luz intermitente.

- ESPECIFICACIONES**
- Batería: CR P2 DC6V Litio. 1 Unidad, con una duración de 3 años a razón de 50.000 usos por año.
 - Presión de trabajo: de 0,5 - 8 Bar.
 - Rango de Sensibilidad: Ajustable.
 - Provisión Tuberia: Rosca 1/2"
 - Tiempo de descarga: Pre descarga: 2 segundos. Descarga final: 7 segundos.

PRECIO
276,67 €



PRECIO **29,95 €**



PRECIO **29,95 €**



PRECIO **29,68 €**



PRECIO **27,19 €**



PRECIO **27,19 €**



PRECIO **29,68 €**

Standard Hidráulica

FX04
MINI FILTRO PARA GRIFO







¡Fácil de instalar!



¡ Agua pura en casa ! Los + del producto



Su estructura microporosa con 3 niveles de filtración (rejilla de filtración, carbón activo y fibra hueca) filtra el agua sin modificar su composición natural (sales minerales, oligoelementos, etc).

- ✓ Elimina el mal olor y sabor a cloro 
- ✓ Reduce las impurezas 
- ✓ Reduce metales pesados 
- ✓ Reduce herbicidas y pesticidas 
- ✓ Reduce la presencia de bacterias 
- ✓ Reduce la presencia de micro-contaminantes 
- ✓ Micro filtración (0.1 µ)
- ✓ Instalación sencilla, sin herramientas 
- ✓ Económico y fácil de usar

Composición del mini filtro

1. Tuerca de fijación
2. Palanca de selección
3. Salida de agua filtrada
4. Salida del agua no filtrada
5. Cartucho
6. Tapa con ventana de cartucho
7. Kit de adaptadores



Uso

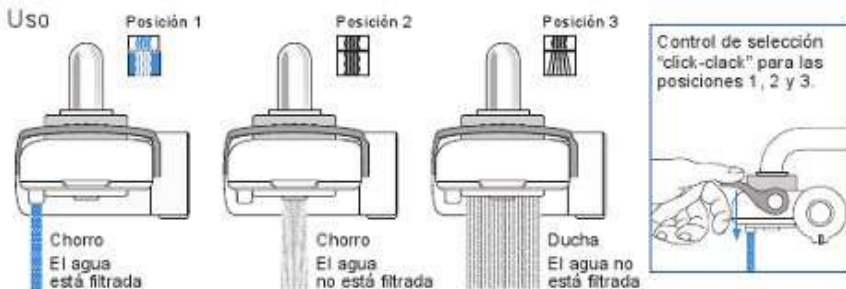

Micro Filtración



FX04 Mini filtro para grifo



- Cuerpo de ABS.
- Cartucho de microfiltración que integra prefiltración; una capa de carbonos activados, un módulo para microfiltración a través de fibras huecas multifilamento en forma de U con 3 capas de filtración.
- Presión de trabajo: 0 - 3,5 bar (fluye una vez se ha cerrado el grifo).
- Caudal de agua filtrada: 150 - 180 l/h (filtro nuevo).
- Temperatura del agua: 5 - 20°C (también puede filtrar agua caliente hasta 50°C).
- Fijación mediante 7 adaptadores de rosca para el grifo, con o sin mezclador.
- Control de selección de 3 posiciones "click-clack" (agua filtrada, agua no filtrada en posición normal y en modo ducha).
- Capacidad del cartucho: hasta 2.000 litros de agua filtrada (dependiendo de la calidad original del agua).
- Con indicador de saturación.

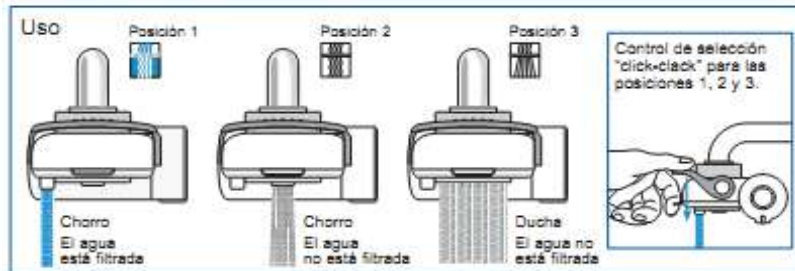

Composición del mini filtro

1. Tuerca de fijación
2. Palanca de selección
3. Salida de agua filtrada
4. Salida del agua no filtrada
5. Cartucho
6. Tapa con ventana de cartucho
7. Kit de adaptadores



Capacidad de filtrado: 2.000 litros.

Por razones técnicas e higiénicas, se recomienda cambiar el cartucho cada 6 meses, incluso aunque el volumen de 2.000 litros no haya sido consumido durante este período.

MINIFILTRO FX04

Referencia	PRECIO
S906000	84,70 €

CARTUCHO RECAMBIO

Referencia	PRECIO
S906001	25,48 €

EXPOSITOR } 6 Minifiltros y 6 cartuchos



18/10/2017

Suministros
FONTANA. S.L.

OFERTA

Grifería Fregadero



771021793

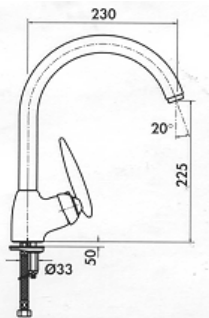

MONOMANDO PLUMA

CODIGO	REFERENCIA	UNIDADES	PRECIO
771021793	130446	1	131,67 €



771024572

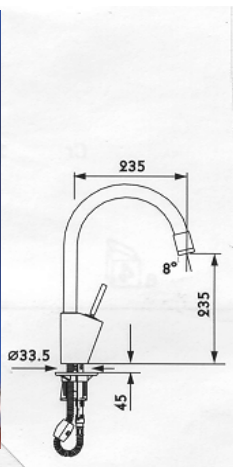

MONOMANDO YOISTY

CODIGO	REFERENCIA	UNIDADES	PRECIO
771024572	130451	1	163,33 €

ALBA

montura cerámica 1/4 de vuelta
tête ceramique 1/4 de tour - ceramic headwork, 1/4 turning

Sobime

65

CROMO
CHROME
CHROME



91030700

PRECIO

75 €

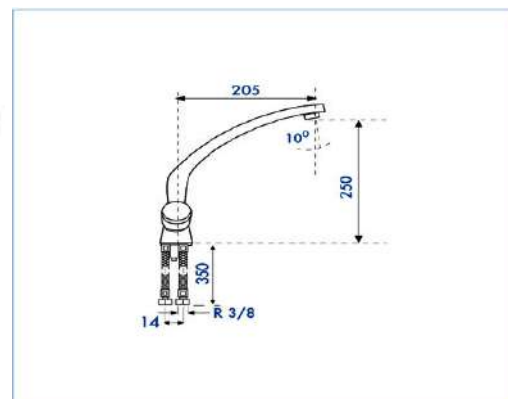

Oferta válida hasta fin de existencias

Nº 283

TOP-TRES

162440

TRES

MAX-TRE



CODIGO	REFERENCIA	UNIDADES	PRECIO
0771027153	162441	1	163,33 €

CODIGO	REFERENCIA	UNIDADES	PRECIO
771032761	162440	1	131,33 €
		6	DTO. 5%



Monomando fregadero vertical ABATIBILE

130335



PRECIO
196,67 €



Monomando fregadero vertical MAX-TRES

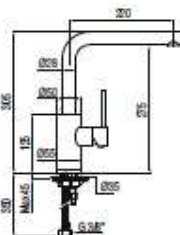

REFERENCIA	UNIDADES	PRECIO
162436	1	165,00 €

Extraible

REFERENCIA	UNIDADES	PRECIO
162437	1	198,33 €

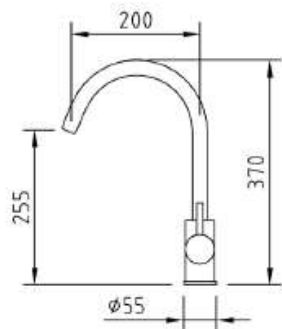

98522 Fregadero Inox Right

98522



INOX

136,15 €

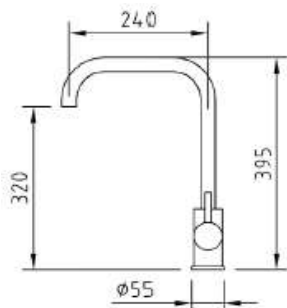

98521 Fregadero Inox Curve

98521

136,15 €



SAONA INOX

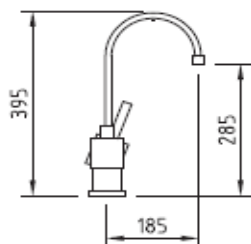

Fregadero

96.855

OFERTA

275,00€

No 285

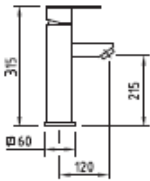
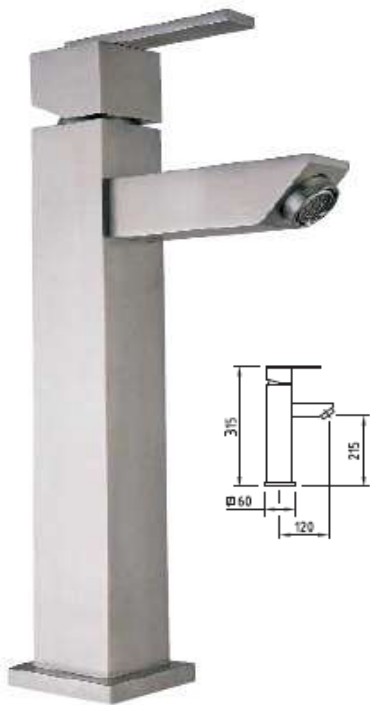

LAVABO ALTO
LONG BASIN
LAVATÓRIO ALTO 96.851

PRECIO
210,00 €

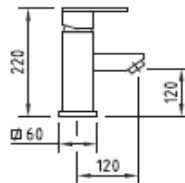
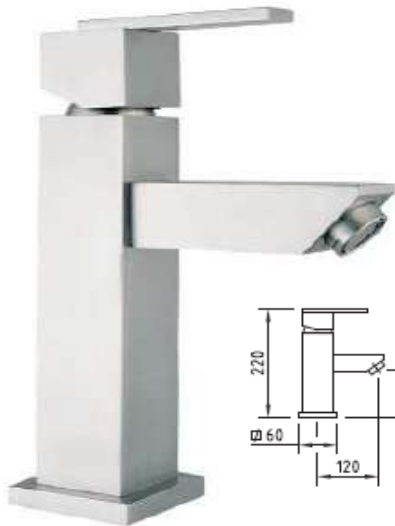

LAVABO
BASIN
LAVATÓRIO 96.850

PRECIO
203,33 €

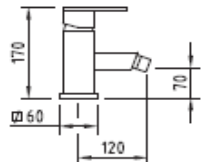

BIDET
BIDET
BIDÉ 96.852

PRECIO
203,33 €



BAÑO-DUCHA
BATH-SHOWER
BANHEIRA 96.853

PRECIO
301,67 €

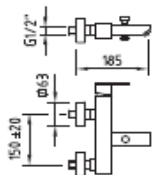

DUCHA
SHOWER
DUCHE 96.854

PRECIO
273,33 €

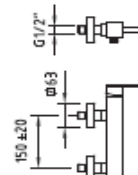



**fregadera monobloc 1866
caño tubo**

		PRECIO
236 700	Cromo	88,70 €
236 799	Latón Viejo	138,83 €

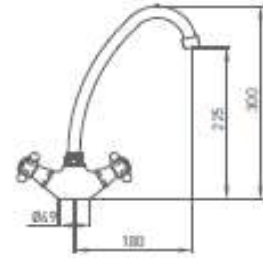

**fregadera monobloc 1866
1 agua**

		PRECIO
238 700	Cromo	71,67 €
238 799	Latón Viejo	101,67 €

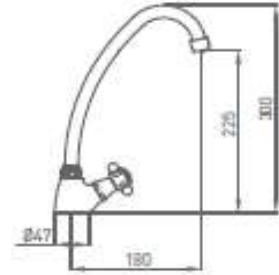

**grifo giratorio caño alto
colección 1866**



Caño de 250 mm – alcance 275 mm

		PRECIO
80 290 800	Cromo	58,33 €
80 920 809	Latón Viejo	91,67 €

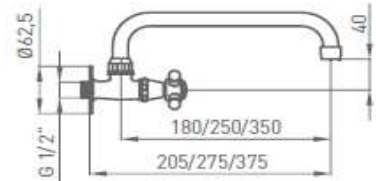

Caño de 250 mm – alcance 290 mm

		PRECIO
80 950 800	Cromo	88,08 €
80 950 809	Latón Viejo	138,33 €

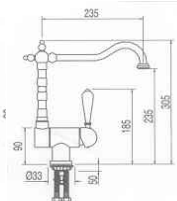

Retro Abatible

COLOR	PRECIO
Cromo	311,67 €
Rústico	406,67 €



COLOR	PRECIO	PRECIO
Cromo	198,33 €	223,20 €
Rústico	275,00 €	320,00 €



Retro

No 290



MONOMANDO
FREGADERO
ABATIBLE

PRECIO
141,25 €



Nº 294

Grupo ducha prelavado cocina industrial con caño, de fijación a pared. Se puede suministrar con ducha con palanca de accionamiento o sin palanca de accionamiento.



Ref.: GGDCCACRDA

Con palanca de accionamiento

CANTIDAD	PRECIO
2	260,00 €



NOVEDAD

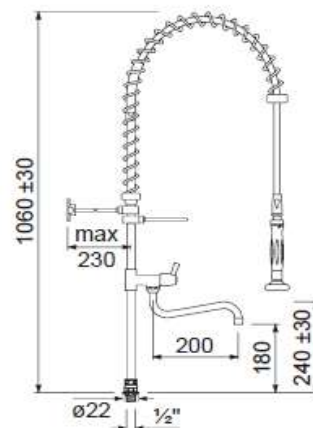

MONOMANDO FREGADERO ORIENTABLE
Cartucho cerámico de 35 mm **NUEVO**

MANGUERA
DE ACERO

2 POSICIONES
ROCIADOR MANUAL
-atomizador y lluvia-

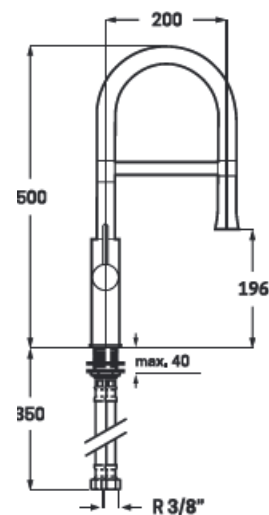

CODIGO	PRECIO
23605	173,73 €



ACABADO
CROMO



ACABADO
CEPILLADO

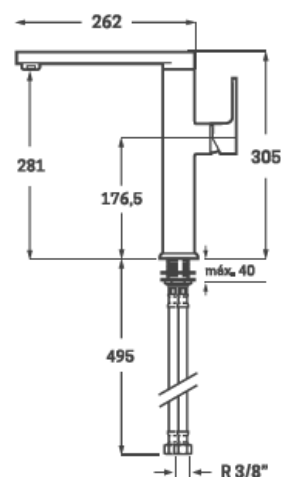

CODIGO	ACABADO	PRECIO
23622	CROMO	154,42 €
23622C	CEPILLADO	163,43 €

Nº 295

11/03/2022

Suministros
FONTANA, S.L.



NOVEDAD
Manguera Flexible



REFORZADO

S E R I E
OMNIA
MONOMANDO
FREGADERO FLEXIBLE
ACABADO CEPILLADO
MANGUERA EN NEGRO

CODIGO	UN	PRECIO/ud
23631N	1	57,46 €
	3	55,34 €

CODIGO	UN	PRECIO/ud
M22119-2	1	77,61 €
	3	70,55 €

Grifería Frogadero



MONOMANDO PARED SM1

PRECIO	95,62 €
--------	----------------



JUEGO FLORONES Y EXCENTRICAS

	PRECIO
Normal	4,97 €
Grande	16,42 €

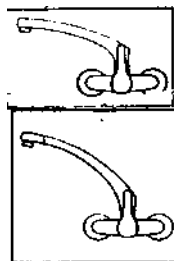

MONOMANDO PARED SM1 serie 64

PRECIO	96,20 €
--------	----------------

MONOMANDO PARED SM1 serie 62

PRECIO	99,75 €
--------	----------------

MONOMANDO ENKEL PARED C/ALTO
Cartucho de 40 mm

MONOMANDO ENKEL PARED 11 cm C/ALTO TUBO
Distancia entre tomas: 11 cm. Cartucho de 40 mm



PRECIO	52,21 €
--------	----------------



REFERENCIA	CAÑO	PRECIO
23606	CONFORMADO	51,23 €
23616	FUNDIDO	61,76 €

MONOMANDO FREGADERO PARED CAÑO BAJO

Cartucho de 40 mm

Incluye todos los accesorios necesarios para su montaje.

REFERENCIA	CANTIDAD	PRECIO
23605	2	50,44 €



MONOMANDO PELUQUERIA SM1

CANTIDAD	PRECIO
2	93,80 €



Grifería Frogadero



MONOMANDO FREGADERA ENKEL

CANTIDAD	PRECIO
2	44,74 €



MONOMANDO FREGADERA CAÑO FUNDIDO ENKEL

CANTIDAD	PRECIO
2	58,61 €



MONOMANDO FREGADERA VERTICAL ARVET

CANTIDAD	PRECIO
2	78,76 €

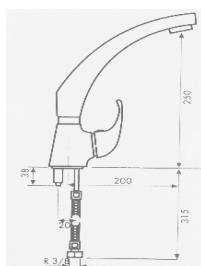

MONOMANDO FREGADERA SM1

CANTIDAD	PRECIO
2	92,29 €



MONOMANDO MEDICAL Encimera

PRECIO	111,67 €
--------	-----------------

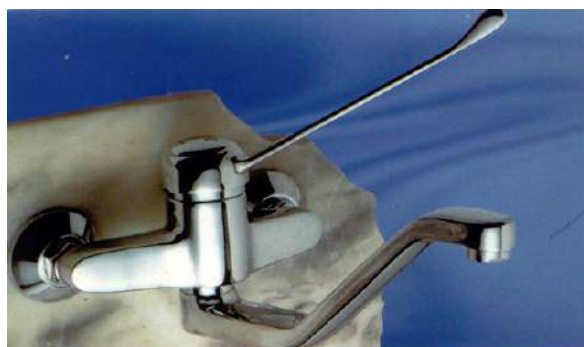

MONOMANDO MEDICAL Pared

PRECIO	123,58 €
--------	-----------------

Grifería Fregadero

Monobloc EXPO

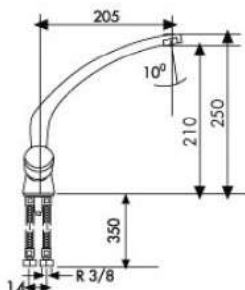

	PRECIO
Caño FUNDIDO	85,28 €
Caño TUBO	64,43 €

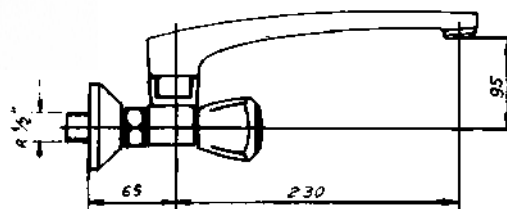

Bateria EXPO

	PRECIO
Ancho 16 cm / Caño Fundido	82,80 €
Ancho 16 cm / Caño Redondo	63,83 €
Ancho 13 cm / Caño Fundido	78,95 €
Ancho 13 cm / Caño Redondo	60,00 €

Bateria FREGADERO VERTICAL	55,18 €
-----------------------------------	----------------



Grifo GIRATORIO VERTICAL

CANTIDAD	PRECIO
2	46,15 €

Grifo GIRATORIO HORIZONTAL

CANTIDAD	PRECIO
2	26,43 €



Grifo FRONTAL 12 cm

CANTIDAD	PRECIO
2	24,15 €
2	26,48 €

Grifo FRONTAL 17 cm





**MONOMANDO UN AGUA VERTICAL
CAÑO GIRATORIO ONE**

ENTRADA DE AGUA ROSCA MACHO 1/2"
EN CAJA INDIVIDUAL A TODO COLOR

REFERENCIA	UN	PRECIO/UD
24602	2	25,08 €



**MONOMANDO UN AGUA PARED
CAÑO HORIZONTAL GIRATORIO ONE**

ENTRADA DE AGUA ROSCA MACHO 1/2"
EN CAJA INDIVIDUAL A TODO COLOR

REFERENCIA	UN	PRECIO/UD
24600	2	22,55 €



MONOMANDO UN AGUA FRONTAL ONE

ENTRADA DE AGUA ROSCA MACHO 1/2"
EN CAJA INDIVIDUAL A TODO COLOR

REFERENCIA	UN	PRECIO/UD
24100	2	22,81 €



MONOMANDO UN AGUA LAVABO ONE

ENTRADA DE AGUA ROSCA MACHO 1/2"
EN CAJA INDIVIDUAL A TODO COLOR

REFERENCIA	UN	PRECIO/UD
24101	2	22,88 €

ECOPRIME

GRB mixers®



ECOPRIME GRIFO ECOLÓGICO LAVABO MONOMANDO

- Altura de 75 mm hasta aireador
- Indica apertura "clic" al 60%
- Abre desde agua fría
- Acabado en cromo

PRECIO

50,49 €

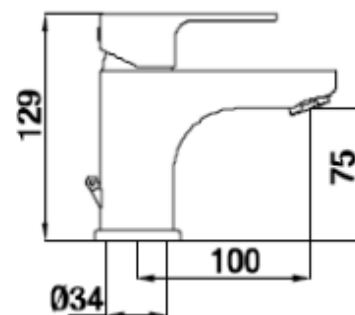

06/



ECOPRIME GRIFO ECOLÓGICO BIDÉ MONOMANDO

- Altura de 38 mm hasta aireador
- Indica apertura "clic" al 60%
- Abre desde agua fría
- Acabado en cromo

PRECIO

50,49 €

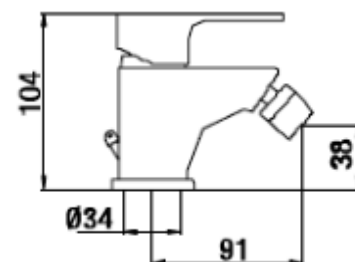

ECOPRIME GRIFO ECOLÓGICO DUCHA MONOMANDO

- Con limitador de caudal 9 l/min
- Mango nuevo Verdi 1F antical, flexo metálico y soporte a pared
- Acabado en cromo

PRECIO

68,45 €

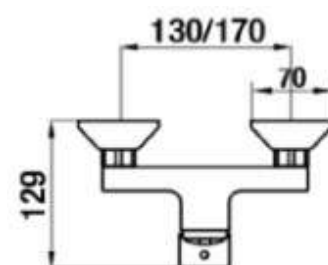

68



ECOPRIME GRIFO ECOLÓGICO BAÑO-DUCHA MONOMANDO

- Con limitador de caudal 9 l/min
- Mango nuevo Verdi 1F antical, flexo metálico y soporte a pared
- Acabado en cromo

PRECIO

78,02 €

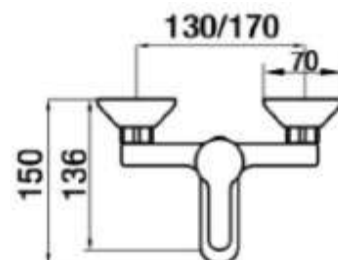

78

PROMOCION

Descuento para caja completa **5%**
Cajas de 12 Ud.

MONOMANDO ENKEL LAVABO

Cartucho de 40 mm.
Conexiones Flexitub (AENOR).
Incluye todos los accesorios necesarios para su montaje.

Código		Código barras	PRECIO
23102	1 / 12	8435136700623	31,43 €

MONOMANDO ENKEL BIDET

Cartucho de 40 mm.
Conexiones Flexitub (AENOR).
Incluye todos los accesorios necesarios para su montaje.

Código		Código barras	PRECIO
23202	1 / 12	8435136700630	31,43 €

MONOMANDO ENKEL BAÑO

Cartucho de 40 mm.
Flexo de acero inoxidable, manual cromado membrana anti-cal,
soporte manual cromado.
Incluye todos los accesorios necesarios para su montaje.

Código		Código barras	PRECIO
23401	1 / 12	8435136700647	48,75 €

MONOMANDO ENKEL DUCHA

Cartucho de 40 mm.
Flexo de acero inoxidable, manual cromado membrana anti-cal,
soporte manual cromado.
Incluye todos los accesorios necesarios para su montaje.

Código		Código barras	PRECIO
23402	1 / 12	8435136700654	38,35 €

TERMOSTATICA ENKEL DUCHA

Fabricada en latón cromado. Cartucho termostático de latón.
Distancia entre tomas = 15 cm. Manual de ducha mod. Ergos (pág.34),
flexo de acero reforzado, soporte de manual de diseño.

Código		Código barras	PRECIO
23002	1 / 5	8435136752448	87,74 €

TERMOSTATICA ENKEL BAÑO

Fabricada en latón cromado. Cartucho termostático de latón.
Distancia entre tomas = 15 cm. Manual de ducha mod. Ergos (pág.34),
flexo de acero reforzado, soporte de manual de diseño.

Código		Código barras	PRECIO
23001	1 / 5	8435136752431	105,29 €

JUEGO BAÑO SM1



MONOMANDO LAVABO

PRECIO
55,75 €



MONOMANDO BIDE

PRECIO
55,38 €



MONOMANDO DUCHA

PRECIO
75,65 €



MONOMANDO BAÑO

PRECIO
80,27 €

Nº 301



SOBIMANDO SM4



95040400
 MONOMANDO BAÑO
 MITIGEUR BAIN-DOUCHE
 SINGLE HANDLE BATH-SHOWER MIXER

PRECIO **70,00 €**

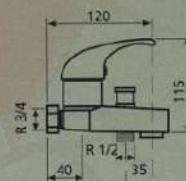

95050400
 MONOMANDO PLATO DUCHA
 MITIGEUR DOUCHE
 SINGLE HANDLE SHOWER MIXER

PRECIO **65,82 €**

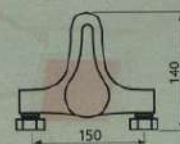

95020400
 MONOMANDO BIDE
 MITIGEUR BIDET
 SINGLE HANDLE BIDET MIXER

PRECIO **46,42 €**

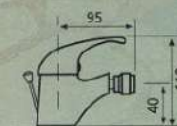

95010400
 MONOMANDO LAVABO
 MITIGEUR LAVABO
 SINGLE HANDLE WASHBASIN MIXER

PRECIO **47,52 €**

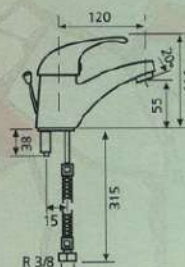

Modelo EXPO

GRUPO BAÑO DUCHA

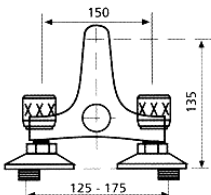

PRECIO
83,93 €

GRUPO DUCHA

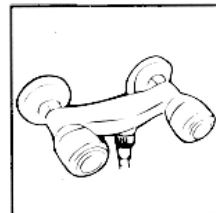

PRECIO
65,00 €

MONOBLOC BIDE

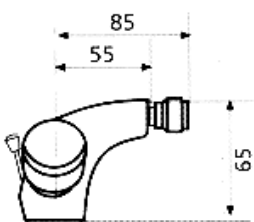

PRECIO
54,53 €

GRIFO LAVABO



PRECIO
28,30 €

GRIFO BIDE



PRECIO
22,83 €

MONOBLOC LAVABO

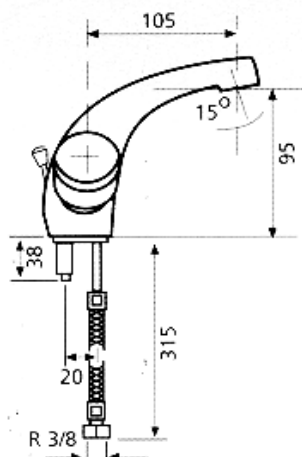

PRECIO
61,38 €

Nº 303

FREGADEROS

Clasica 50

Acero inoxidable AISI 304 18/10

Fregaderos
Acero Pulido



MODELO	CODIGO	REFERENCIA	DIMENSIONES	PRECIO
3415			450 x 435 total 440 x 425 encastre 340 x 370 x 160 cubeta	80,98 €
Mueble 40 cm				



MODELO	CODIGO	REFERENCIA	DIMENSIONES	PRECIO
3417.2			800 x 435 total 776 x 411 encastre 340 x 370 x 160 cubeta	100,65 €
Mueble 45 cm				

3517			800 x 510 total 785 x 495 encastre 340 x 400 x 160 cubeta	102,85 €
------	--	--	---	-----------------



MODELO	CODIGO	REFERENCIA	DIMENSIONES	PRECIO
3416.2			800 x 435 total 776 x 411 encastre 340 x 370 x 160 cubeta	123,66 €
Mueble 80 cm				

3516			800 x 510 total 785 x 495 encastre 340 x 400 x 160 cubeta	128,29 €
------	--	--	---	-----------------



MODELO	CODIGO	REFERENCIA	DIMENSIONES	PRECIO
3419			1200 x 435 total 1190 x 425 encastre 340 x 370 x 160 cubeta	196,99 €
Mueble 80 cm				

3519*			1200 x 510 total 1190 x 500 encastre 340 x 370 x 160 cubeta	205,65 €
Mueble 80 cm				

**TODOS LOS FREGADEROS
VIENEN CON VALVULA
CESTA**

FREGADEROS

Diseño

Acero inoxidable AISI 304 18/10

Fregaderos
Acero Pulido



MODELO	CODIGO	REFERENCIA	DIMENSIONES	PRECIO
1415			Ø 460 total Ø 440 encastre Ø 400 x 180 cubeta	89,29 €
Mueble 45 cm				



MODELO	CODIGO	REFERENCIA	DIMENSIONES	PRECIO
1415.6			Ø 510 total Ø 494 encastre Ø 400 x 180 cubeta	104,50 €
Mueble 45 cm				



MODELO	CODIGO	REFERENCIA	DIMENSIONES	PRECIO
1317.2*			835 x 440 total 811 x 416 encastre Ø 380 x 160 cubeta	109,64 €
Mueble 45 cm				



MODELO	CODIGO	REFERENCIA	DIMENSIONES	PRECIO
1316			835 x 440 total 811 x 416 encastre Ø 365 x 160 cubeta	128,06 €
Mueble 80 cm				

**TODOS LOS FREGADEROS
VIENEN CON VALVULA
CESTA**

30/12/2021

FREGADEROS

Diseño Roma

Acero inoxidable AISI 304 18/10

Fregaderos
Acero Pulido

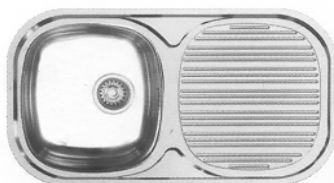

MODELO	CODIGO	REFERENCIA	DIMENSIONES	PRECIO
3617.2*			800 x 450 total	
			778 x 428 encastre	109,51 €
Mueble 45 cm			340 x 370 x 160 cubeta	



MODELO	CODIGO	REFERENCIA	DIMENSIONES	PRECIO
3616.2			800 x 450 total	123,37 €
			778 x 428 encastre	
Mueble 80 cm			340 x 370 x 160 cubeta	

**TODOS LOS FREGADEROS
VIENEN CON VALVULA
CESTA**



FREGADEROS

Bajo Encimera

Acero inoxidable AISI 304 18/10
Pulido Brillo Alta Resistencia
Espesor de chapa 1 mm

Fregaderos
Acero Pulido



MODELO	CODIGO	REFERENCIA	DIMENSIONES	PRECIO
31453	331453	05/48140/15	378 x 438 Total 340 x 400 x 200 cubeta	109,91 €

Mueble 40 cm

31454	331454	05/56260/15	440 x 440 total 400 x 400 x 200 cubeta	117,34 €
-------	--------	-------------	---	-----------------

Mueble 50 cm



MODELO	CODIGO	REFERENCIA	DIMENSIONES	PRECIO
U9000	U9054	05/81200/15	540 x 400 Total 482 x 342 Interior	81,59 €

Mueble 60 cm

31455	331455	05/65540/15	487 x 438 Total 450 x 400 x 200 cubeta	141,60 €
-------	--------	-------------	---	-----------------

Mueble 60 cm



MODELO	CODIGO	REFERENCIA	DIMENSIONES	PRECIO
31155	331155	22/58441/15	Ø 460 total Ø 400 x 180 cubeta	123,89 €

Mueble 45 cm



MODELO	CODIGO	REFERENCIA	DIMENSIONES	PRECIO
31259	331259	05/134148/16	803 x 455 Total 759 x 415 Interior	132,55 €

Mueble 80 cm

**TODOS LOS FREGADEROS
VIENEN CON VALVULA
CESTA**

**PLATOS DE DUCHA PORCELANA VITRIFICADA
sobre Acero**



MEDIDAS			ENVASE	PRECIO
A	B	E		
90	90	16	2	83,08 €
			6	65,00 €

PLATOS DE DUCHA INOX



MEDIDAS			ENVASE	PRECIO
A	B	E		
80	80	16	2	180,00 €

← **Oferta**

Pack VERDE



PACK INODORO COMPLETO

Tapa Amortiguada
Descargador Doble Pulsador

PRECIO

359,67 €

rimless system

Distribucion de agua total

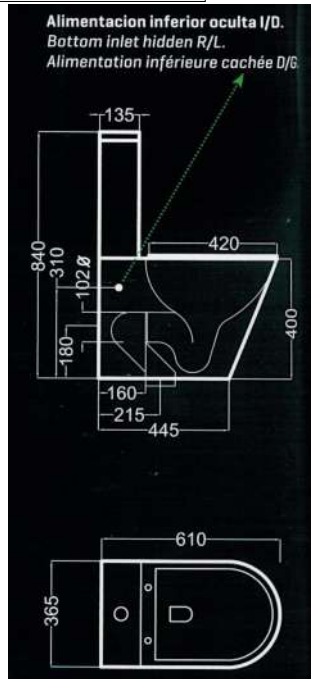

Bidet a suelo
Floor-standing bidet
Bidet au sol

23,6 Kg

PRECIO

185,00 €

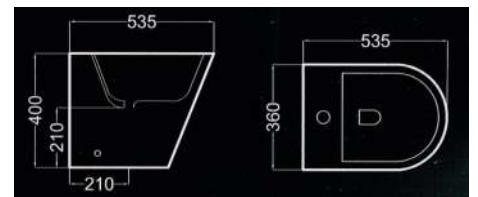

27/06/2022

Lavabo



LAVABO con PEDESTAL 65,45 €



Bidé



BIDET 61,67 €



Inodoro

SANITARIO PACK "EASY"

Nº 316

Pack LUXOR



Contiene 1 inodoro Benissa + 1 cisterna CETUS + 1 asiento thermoplast

PRECIO	175,94 €
---------------	-----------------

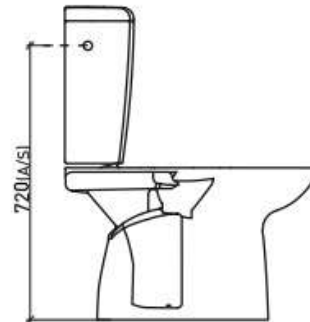
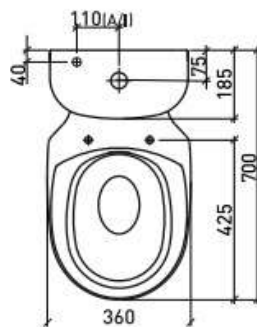
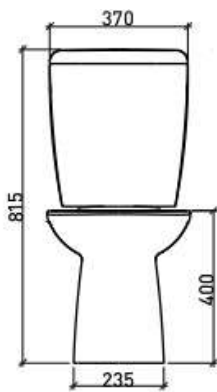

COVID-19

Mascarilla PLEXCOM

OEKO-TEX®
CONFIDENCE IN TEXTILES
STANDARD 100



Mascarilla Higiénica Reutilizable Plexcom de algodón y poliéster de doble capa. Materiales con tecnología HeiQ Viroblock NPJ03, tratamiento con alta efectividad probada neutralizadora de bacterias y virus , COVID-19 incluido.

Costura frontal elástica para orejas y tejido hipoalergénico. Certificado OEKO-TEX Clase I. Certificación por Organismo Notificado EU y fabricado según UNE0065.

Propiedades de tratamiento según ISO20743 Determinación de la antibacterina de los productos textiles ISO 18184

Determinación de actividad antiviral.

Eficacia de filtración $\geq 90\%$

Altamente resistente hasta 25 lavabos.

Colores disponibles: azul y negro

PRECIO

6,60 €



Mascarilla médica desechable (quirúrgica TIPOII-R) de un solo uso.

Triple capa con acabados termosellados , elásticos de sujeción y clip nasal ajustable.

A prueba de polen anti-gotas

Alta eficacia de filtración bacteriana $\geq 98\%$

Respirabilidad: ≤ 60 Pa/cm².

Resistencia a las salpicaduras: ≥ 16 kPa

Limpieza microbiológica ≤ 30 UFG/g

Cumplimiento normativa 93/42/CEE

Norma EN 14683:2019+AC:2019

PRECIO

Pack 5 mascarillas

1,73 €

QUIRÚRGICA
TIPO IIR

EN14683 : 2019 + AC : 2019

CE

COVID-19



SOLUCIÓN PROFESIONAL NORDEN®

XPERT CROWN AER®

HIGIENIZANTE BASE ALCOHOL
PARA SUPERFICIES Y UTENSILIOS

SUMINISTROS
FONTANA, S.L.



XPERT CROWN Spray Higiénizante

Solución alcohólica multiusos concebida para limpiar todo tipo de superficies y utensilios:

Encimeras, estanterías, pasamanos, ascensores, pomos de puerta, mesas de escritorio, teclados de ordenador, mobiliario de oficina, teléfonos, llaves, dispositivos electrónicos, porcelanas vitrificadas, interior de coches, volante, maletero, cambio de marchas, equipos y aparatos de gimnasios, bicicletas, mobiliario de terraza, tumbonas, sillas, colchonetas, equipaje, mochilas, llaves, monedas, pupitres y bancos en colegios, alfombrillas, calzados, mostradores de establecimientos de comercio, cestas y carros desupermercado, herramientas, transpaletas, carretillas eléctricas, etc.

PRECIO

24,36 €



HAND CROWN Gel Hidroalcohólico con Aloe Vera



Gel hidroalcohólico especialmente indicado para el tratamiento de la piel.

Fórmula enriquecida con aloe vera que aporta hidratación y cuida la piel.

Especificaciones: Aspecto: Gel líquido transparente.

Color: Azul.

Densidad: $0,87 \pm 0,02$ g/cc

Olor: Característico.

Valor de pH: $7,5 \pm 0,5$.

Envase 500ml

PRECIO

13,35 €

Suministros Fontana, S. L.

Verdeal, 77A, Domaio

36957 Moaña

PONTEVEDRA

Tel. fijo: 986 32 71 31

Tel. Móvil: 610 46 10 01

Fax.: 986 32 71 40